

High Feed Mill

HFM



Small Diameter Machining High Feed Tool

Stable machining, high efficiency milling tools
For small diameter machining.

▣ **High Feed / High Efficiency Machining**

Increase productivity through improved insert shape and size, high feed per tooth, and many cutting edges, for small diameter machining.

▣ **High Speed / High Hardness Machining**

Stable tool life through the combination of the reinforced toughness on corner and suitable grades of high hardness in the area of high speed and high hardness.



HFM

High Efficiency Milling Tool for Small Diameter Machining High Feed Mill(HFM)

The need for high feed tooling has grown while the materials of molds tend to be harder. Small size tooling is required for the electronic parts and mold manufacturers to achieve high productivity.



Insert

However, increasing productivity has been restricted due to the absence of small size high feed tools for high hardness steel.

HFM extends the range of process to small diameter, improving productivity with more number of teeth, compared to HRM(D).



Shank

High Helix angle on the cutting edge reduces cutting resistance, while the negative axial rake angle of holder reduces the contact surface on workpiece, reducing wear and vibration and increasing stability. Improved grades ensure stable tool life. Ultrafine grain substrate and specialized coating layer highly improve anti-chipping and anti-wear.



Modular

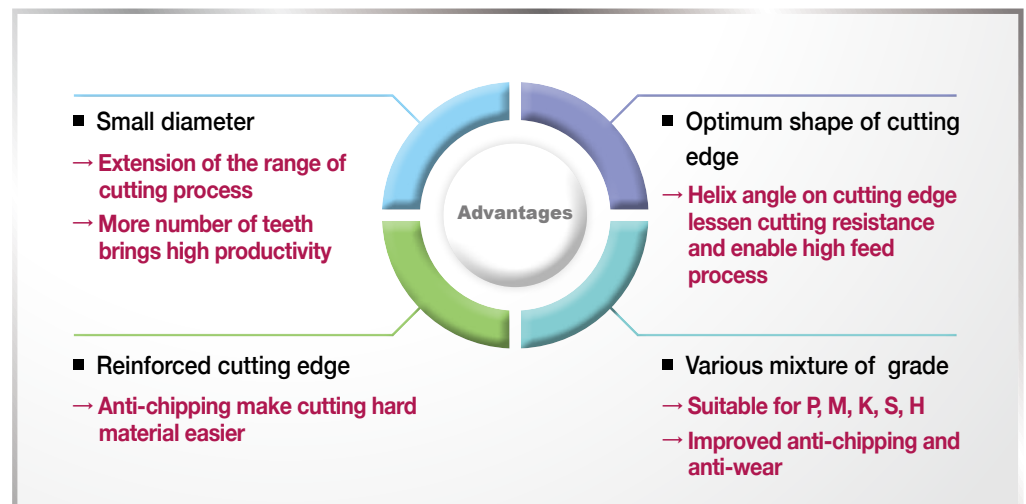

Code System

[Shank Type]

HFM	S	1	010	H	R	- 2	L	10
High Feed Mill	Tool type S : Shank	Inscribed circle of insert 1:04type insert	Tool Dia. 010 : Ø10	Coolant type No code : None H : Thru-hole	Hand R : Right L : Left	No. of tooth 2 : 2teeth	Shank length S : Standard type M : Middle type L : Long type	Shank Dia. 10 : Ø10

[Modular Type]

HFM	M	1	010	H	R	- M06
High Feed Mill	Tool type M : Modular	Inscribed circle of insert 1:04type insert	Tool Dia. 010 : Ø10	Coolant type No code : None H : Thru-hole	Hand R : Right L : Left	M Dimensions

[Modular Adapter]

MAT	- M10	- 010	- S20	S	- C	- 170
Modular Adapter	M Dimensions M10	Neck length 010 : 10mm	Shank Dia. S20 : Ø20	Neck type T : Taper S : straight	Adaptor material Unmarked : Steel C : Carbide	Adaptor length 170 : 170mm

⇒ Features

- Apply helix cutting edge on insert, low cutting load and reinforce toughness on corner
- Increased rigidity with double relief angle (11, 13), prevent interference with high feed
- To apply the negative axial rake angle when set up the holder, increased chipping resistance
- Tool life is increased with suitable C/B and grade for every material

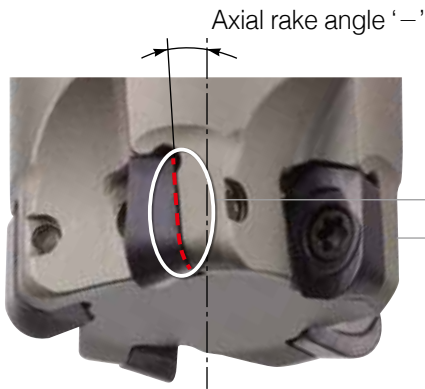

Holder Setup

- To set up the negative axial rake angle, increased chipping resistance

No. of tooth

- Increased Tool life with increased flutes
- HRM(D) Ø20 (2 flutes) → HFM Ø20 (5 flutes)

Relief angle

- 11, 13 double relief angle increase rigidity and prevent interference

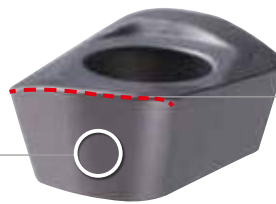

Major cutting edge

- Apply helix cutting edge
- Improved sharpness of principle edge
- Improved toughness of corner edge

⇒ Application Area

- Good performance at machining small diameter (Ø8~Ø20) with small size and shape of HFM

Application Area (ap & Diameter)

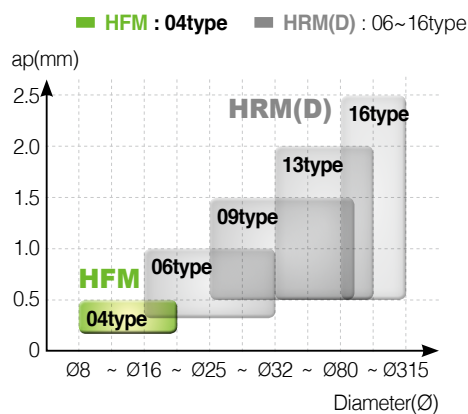

Application Area (ap & fz)

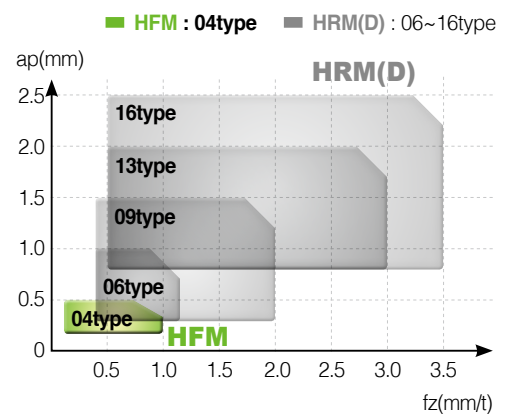

⇒ Usage and Features of Chip Breakers

Chip Breaker	Cutting edge	Applications	Features
MF		<ul style="list-style-type: none"> • Fine finishing • Titanium & Inconel machining 	Low cutting resistance C/B, suitable for light cutting
None C/B		<ul style="list-style-type: none"> • Super hard material machining 	High toughness shape, suitable for hard die steel cutting

Performance Test

- Recommended grades have been applied according to workpiece
- Better performance than competitors under high feed rate

High speed machining

- Workpiece X155CrVMo12-1 (HrC40~45)
- Insert LPM(E)W0402□□R
- Recommended grade PC2505(1st), PC2510(2nd)

- Workpiece X155CrVMo12-1 (Over HrC60)
- Insert LPM(E)W0402□□R
- Recommended grade PC2505(1st), PC2510(2nd)

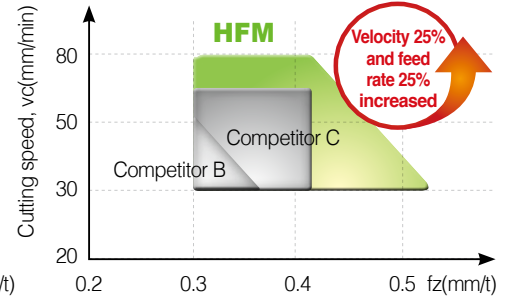
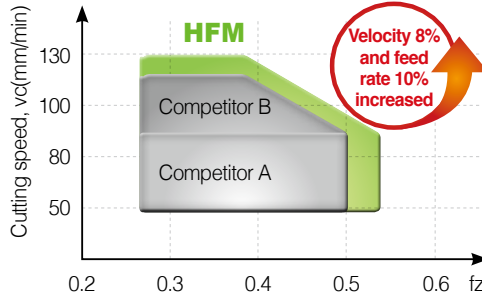

- High Helix and advanced technology have been applied to edge geometry.
- Better performance than competitors under high feed rate

High feed machining

- Workpiece 1.2738 (Improved) (HrC30~40)
- Insert LPMT0402□□R-MF
- Recommended grade PC5300(1st), PC2510(2nd)

- Workpiece TiAl6V4 (HrC40~45)
- Insert LPMT0402□□R-MF
- Recommended grade PC5300(1st), PC5400(2nd)

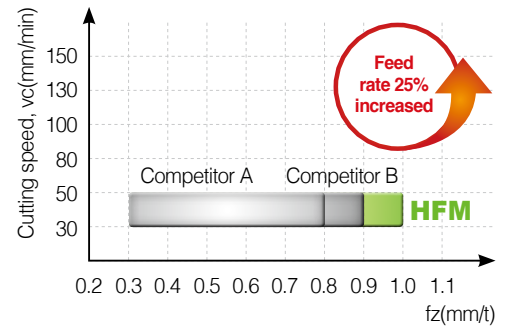
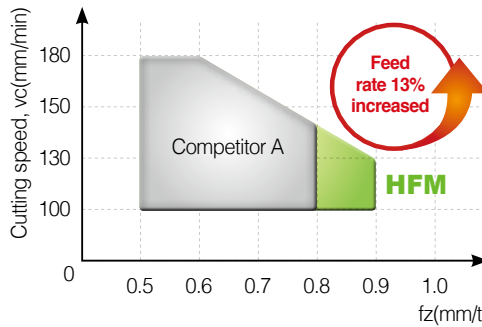

- New Grades; PC2505 and PC2510 are the 1st recommendation for high hardened

Grade	Hardness
PC2505	Over HrC45
PC2510	HrC35~50
PC5300	HrC20~40
PC5400	Under HrC37

High hardness machining

[Recommended grades according to interruption]

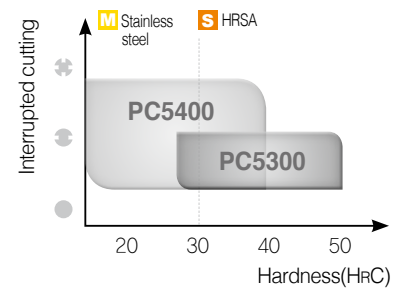
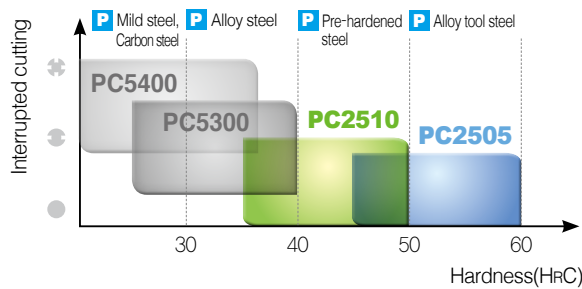

[Recommended grades according to velocity]

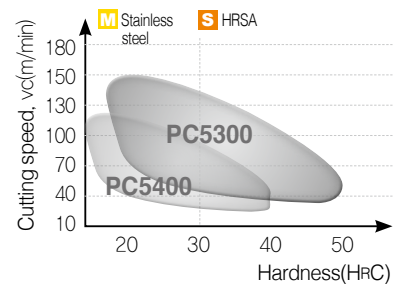
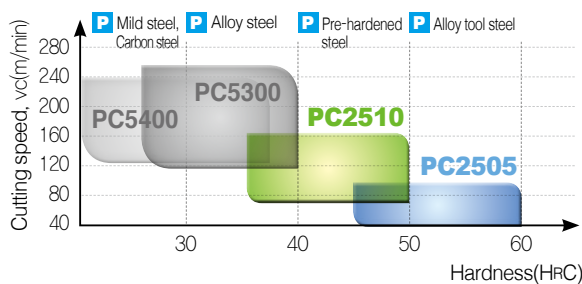

Performance Test

Effective machining

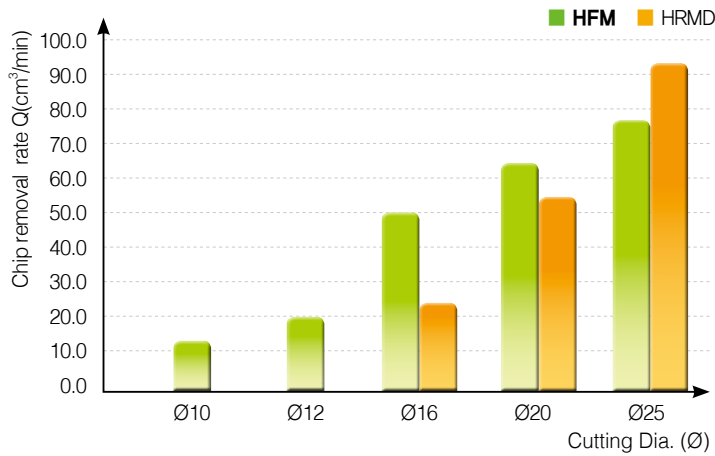

[Machining center]

- BT40 and under, HFM recommended
- BT50 and above, HRM(D) recommended

[Chip removal rate Q(cm³/min)]

- Ø8~Ø20, HFM recommended
- Ø20 and above, HRM(D) recommended

Recommended Cutting Conditions

※ Recommended chip breaker :
● First ○ Second



Workpiece		Workpiece			HB (HrC)	Grade	Cutting conditions				Chip breaker		
		KOR (KS)	USA (AISI)	GER (DIN)			vc (m/min)	fz (mm/t)	ap (mm)	ae (mm)	MF	None C/B	
P	Mild steel	SM20C	1020	C22	120~180	PC5400 (PC5300)	100~220	0.5~1.0	~0.5	0.7D~0.1D	●	-	
	Carbon steel	SM45C	1045	C45	200	PC5400 (PC5300)	100~200	0.5~1.0	~0.5	0.7D~0.1D	●	-	
	Alloy steel	SCM440	4140	41CrMo4	270(28)	PC5300	100~200	0.5~1.0	~0.5	0.7D~0.1D	●	-	
	Pre-hardened steel	KP4M	P20 (Improved)	1.2738 (Improved)	300(32)	PC5300 (PC2510)	100~180	0.5~0.9	~0.4	0.7D~0.1D	●	○	
		NIMAX	P21 (Improved)	-	370(40)	PC5300 (PC2510)	100~180	0.5~0.9	~0.4	0.7D~0.1D	●	○	
		CENA1	P21 (Improved)	-	370(40)	PC5300 (PC2510)	100~180	0.5~0.9	~0.4	0.7D~0.1D	●	○	
		NAK80	P21 (Improved)	-	400(43)	PC5300	100~160	0.5~0.7	~0.4	0.7D~0.1D	○	-	
	Alloy tool steel	STAVAX	420	X30Cr13	510(52)	PC2510 (PC5300)	80~150	0.3~0.6	~0.4	0.7D~0.1D	●	-	
		STD11 STD61	D2 H13	X155CrVMo12-1 X40CrMoV5-1	-(40~50)	PC2510 (PC2505)	80~130	0.3~0.55	~0.3	0.7D~0.1D	-	●	
STD11 (Cold forging)		D2	X155CrVMo12-1	630(60)	PC2505	30~75	0.3~0.5	~0.2	0.7D~0.1D	-	●		
M	Stainless steel	STS316	316	X5CrNiMo17-12-2	Under 270	PC5400 (PC5300)	70~150	0.5~0.7	~0.5	0.7D~0.1D	●	-	
K	Gray cast iron, Ductile cast iron	GCD450	65-45-12	GGG40.3	Tensile Strength Over 450Mpa	PC5300	130~220	0.6~0.8	~0.5	0.7D~0.1D	●	-	
S	HRSA	Fe series	Incoloy901	N09901	-(WS 2.4662)	-(25~35)	PC5300 (PC5400)	30~100	0.3~0.5	~0.3	0.4D~0.7D	●	○
		Ni or Co series	Inconel718	N07718	NiCr19FeNbMo (WS 2.4668)	-(35~45)	PC5300 (PC5400)	20~50	0.3~0.6	~0.3	0.4D~0.7D	●	○
	Titanium	Ti-6Al-4V	R56400	TiAl6V4	-(40~45)	PC5300	30~50	0.4~1.0	~0.3	0.7D~0.1D	●	-	

➤ Cutting Performance



[Competitor]

- Chip removal rate $Q(\text{cm}^3/\text{min})$: 11.5
- Cutting time(min) : 30

Carbon steel [C45(DIN) / 1045(AISI) / SM45C(KS), HB200]

- Workpiece Mold
- Cutting conditions $vc(\text{m}/\text{min}) = 150$, $fz(\text{mm}/\text{t}) = 0.6$, $ap(\text{mm}) = 0.4$, $ae(\text{mm}) = 5$, dry
- Tools Insert LPMT040210R-MF (PC5300)
Holder HFMS1010HR-2S10

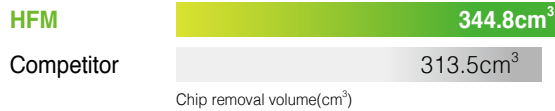

➤ **Wear-resistance & anti-chipping increased due to helix cutting edge when machining carbon steel**



[Competitor]

- Chip removal rate $Q(\text{cm}^3/\text{min})$: 15
- Cutting time(min) : 3.29

Pre-hardened steel [P21(Improved) (AISI) / NAK80(KS), HRC40~41]

- Workpiece Mold
- Cutting conditions $vc(\text{m}/\text{min}) = 100$, $fz(\text{mm}/\text{t}) = 1.26$, $ap(\text{mm}) = 0.3$, $ae(\text{mm}) = 10$, dry
- Tools Insert LPMT040210R-MF (PC5300)
Holder HFMS1016HR-4S16

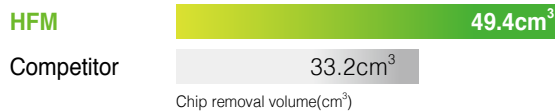

➤ **Anti-chipping in high feed increased due to optimized cutting edge when machining pre-hardened steel**



[Competitor]

- Chip removal rate $Q(\text{cm}^3/\text{min})$: 14.3
- Cutting time(min) : 1.26

Pre-hardened steel [X30Cr13(DIN) / 420(AISI) / STAVAX(KS), HRC50~51]

- Workpiece Mold
- Cutting conditions $vc(\text{m}/\text{min}) = 200$, $fz(\text{mm}/\text{t}) = 0.6$, $ap(\text{mm}) = 0.3$, $ae(\text{mm}) = 10$, dry
- Tools Insert LPMT040210R-MF (PC2510)
Holder HFMS1016HR-4S16



➤ **Wear-resistance increased comparing to competitors when machining pre-hardened steel**



➤ Cutting Performance



[Competitor]

- Chip removal rate $Q(\text{cm}^3/\text{min})$: 4.8
- Cutting time(min) : 25

Alloy tool steel [X155CrVMo12-1(DIN) / D2(AISI) / STD11(KS), HRC40~45]

- Workpiece Mold
- Cutting conditions $vc(\text{m}/\text{min}) = 80$, $fz(\text{mm}/\text{t}) = 0.5$, $ap(\text{mm}) = 0.3$, $ae(\text{mm}) = 10$, dry
- Tools Insert LPMW040210R (PC2510)
Holder HFMS1016HR-4S16



➤ **Anti-breakage increased due to optimized shape and grade when machining alloy tool steel**



[Competitor]

- Chip removal rate $Q(\text{cm}^3/\text{min})$: 1.4
- Cutting time(min) : 7.85

Alloy tool steel [X155CrVMo12-1(DIN) / D2(AISI) / STD11(KS), HRC60]

- Workpiece Mold
- Cutting conditions $vc(\text{m}/\text{min}) = 75$, $fz(\text{mm}/\text{t}) = 0.4$, $ap(\text{mm}) = 0.15$, $ae(\text{mm}) = 5$, dry
- Tools Insert LPMW040210R (PC2505)
Holder HFMS1010HR-2S10

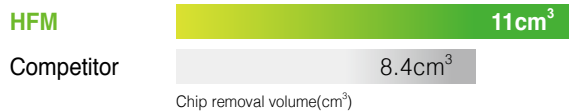

➤ **Wear-resistance increased due to optimized shape and grade when machining alloy tool steel**



[Competitor]

- Chip removal rate $Q(\text{cm}^3/\text{min})$: 7.2
- Cutting time(min) : 10.05

HRSA [TiAl6V4(DIN) / R56400(AISI) / Ti-6Al-4V(KS), HRC48]

- Workpiece Aviation parts
- Cutting conditions $vc(\text{m}/\text{min}) = 50$, $fz(\text{mm}/\text{t}) = 1.2$, $ap(\text{mm}) = 0.3$, $ae(\text{mm}) = 10$, wet
- Tools Insert LPMT040210R-MF (PC5300)
Holder HFMS1016HR-4S16

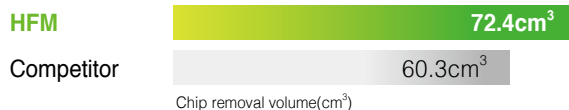

➤ **Wear-resistance increased due to optimized shape of cutting edge when machining HRSA**



HFM

Ramping and Helical cutting

Ramping

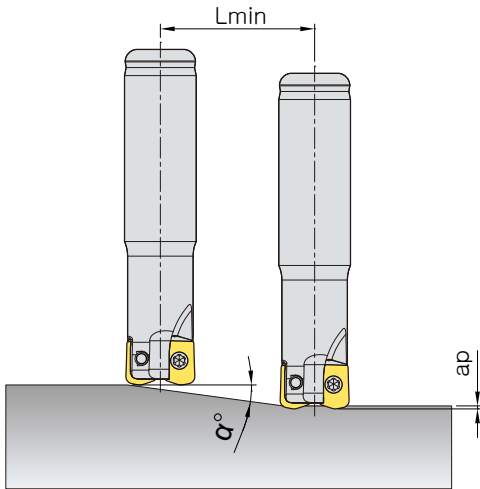

$$L_{min} = \frac{a_p}{\tan \alpha^\circ} \text{ (mm)}$$

- ※ Lmin: Min. inclination cutting length
- α° : Max. ramping angle
- ap : Depth of cut

Helical cutting

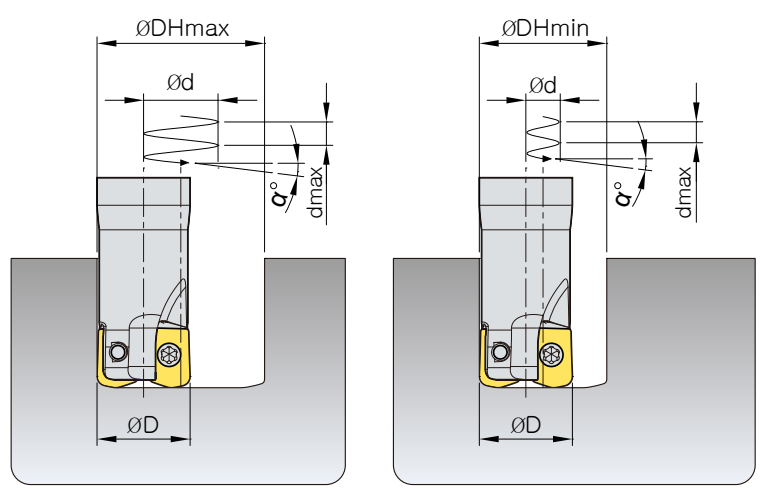

- ØD = Tool Dia.(mm)
- Ød = Tool path(mm) = ØDHmin, max - ØD
- ØDHmin(Min diameter, mm) = ØD × 2 - 5.4
- ØDHmax(Max diameter, mm) = ØD × 2 - 2

(mm)

Designation	Tool Dia. ØD	Depth of cut ap	Ramping		Helical cutting			
			Max ramping angle α(°)	Lmin	Max diameter ØDHmax	Max pitch dmax	Min diameter ØDHmin	Max pitch dmax
HFMS1010HR	10	0.4~0.5	3.5	7	18	0.4	15	0.4
HFMS1011HR	11	0.4~0.5	3.1	8	20	0.4	17	0.4
HFMS1012HR	12	0.4~0.5	2.7	9	22	0.4	19	0.4
HFMS1013HR	13	0.4~0.5	2.4	10	24	0.4	21	0.4
HFMS1014HR	14	0.4~0.5	2.2	11	26	0.4	23	0.4
HFMS1015HR	15	0.4~0.5	2.0	12	28	0.4	25	0.4
HFMS1016HR	16	0.4~0.5	1.8	13	30	0.4	27	0.4
HFMS1017HR	17	0.4~0.5	1.7	14	32	0.4	29	0.4
HFMS1018HR	18	0.4~0.5	1.6	15	34	0.4	31	0.4
HFMS1019HR	19	0.4~0.5	1.5	16	36	0.4	33	0.4
HFMS1020HR	20	0.4~0.5	1.4	17	38	0.4	35	0.4
HFMS1021HR	21	0.4~0.5	1.3	18	40	0.4	37	0.4
HFMM1025HR	25	0.4~0.5	1.1	22	48	0.4	45	0.4
HFMM1026HR	26	0.4~0.5	1.0	23	50	0.4	47	0.4
HFMM1030HR	30	0.4~0.5	0.9	27	58	0.4	55	0.4
HFMM1032HR	32	0.4~0.5	0.8	29	62	0.4	59	0.4
HFMM1033HR	33	0.4~0.5	0.8	30	64	0.4	61	0.4

- Adjust feed to under 70% of recommended cutting condition when ramping & helical cutting
- In helical ramping, max. cutting depth(dmax) per 1 helical revolution of cutter should not exceed max. cutting depth(ap) as per insert size
- In ramping, max. cutting depth per 1 ramping process of cutter should not exceed max. depth of cut as per used insert size

➔ Corner R programming

(mm)

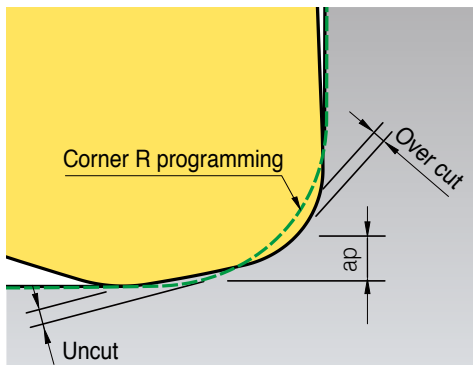

Insert	Corner R programming	Cutting conditions		Over Cut	Uncut
		Nose R	Max. ap		
LPMT040210R-MF LPMW040210R LPEW040210R	R1.0(Standard)	1.0	0.4	0	0.17
	R1.5			0.10	0.08
	R2.0			0.31	0
LPMT040220R-MF LPMW040220R LPEW040220R	R1.0	2.0	0.5	0	0.41
	R1.5			0	0.2
	R2.0(Standard)			0	0

- When using CNC program, overcut & uncut occurs on the corner processing site if entering the correct program corner R value for each insert
- To prevent overcut, you will need to complete a CNC program considering the above overcut

➔ Insert

(mm)

Designation	Usage	Coated				Dimensions(mm)						Depth of cut	Configuration
		PC5300	PC5400	PC2510	PC2505	l	d	t	r	d ₁	ap		
LPMT	040210R-MF	●	●	●	-	6.4	4.2	2.6	1.0	2.0	0.4	Fine finishing	
	040220R-MF	●	●	●	-	6.4	4.2	2.6	2.0	2.0	0.5		
LPMW	040210R	●	-	●	●	6.4	4.2	2.6	1.0	2.0	0.4	High hardness material machining	
	040220R	●	-	●	●	6.4	4.2	2.6	2.0	2.0	0.5		
LPEW	040210R	●	-	●	●	6.4	4.2	2.6	1.0	2.0	0.4	High hardness material machining	
	040220R	●	-	●	●	6.4	4.2	2.6	2.0	2.0	0.5		

➔ Parts

Specification	Screw	Wrench
~Ø10 Ø11~Ø33		
	FTKA01840	TW06S-A
	FTKA01842	

HFM

HFMS1000 (Shank)

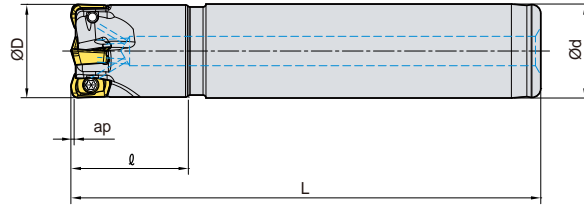

AA
13°

·AR: -4°
·RR: -14°~-7°

(mm)

Designation			ØD	Ød	ℓ	L	ap	
HFMS	1008HR-1S10	1	8	10	20	80	0.4~0.5	0.03
	1008HR-1M10	1	8	10	25	100	0.4~0.5	0.03
	1008HR-1L10	1	8	10	35	120	0.4~0.5	0.03
	1010HR-2S08	2	10	8	20	80	0.4~0.5	0.03
	1010HR-2M08	2	10	8	25	100	0.4~0.5	0.04
	1010HR-2L08	2	10	8	35	120	0.4~0.5	0.04
	1010HR-2S10	2	10	10	20	80	0.4~0.5	0.04
	1010HR-2M10	2	10	10	25	105	0.4~0.5	0.05
	1010HR-2L10	2	10	10	35	120	0.4~0.5	0.06
	1011HR-2S10	2	11	10	20	80	0.4~0.5	0.04
	1011HR-2M10	2	11	10	25	105	0.4~0.5	0.06
	1011HR-2L10	2	11	10	35	120	0.4~0.5	0.07
	1012HR-3S10	3	12	10	20	80	0.4~0.5	0.05
	1012HR-3M10	3	12	10	25	105	0.4~0.5	0.06
	1012HR-3L10	3	12	10	35	120	0.4~0.5	0.07
	1012HR-3S12	3	12	12	20	80	0.4~0.5	0.06
	1012HR-3M12	3	12	12	25	105	0.4~0.5	0.08
	1012HR-3L12	3	12	12	35	120	0.4~0.5	0.09
	1013HR-3S12	3	13	12	20	80	0.4~0.5	0.06
	1013HR-3M12	3	13	12	25	105	0.4~0.5	0.09
1013HR-3L12	3	13	12	40	120	0.4~0.5	0.10	
1014HR-3S12	3	14	12	20	80	0.4~0.5	0.07	
1014HR-3M12	3	14	12	25	105	0.4~0.5	0.09	
1014HR-3L12	3	14	12	40	120	0.4~0.5	0.10	

Available Inserts



LPMT-MF



LPMW



LPEW

Designation	Usage	Coated			
		PC5300	PC5400	PC2510	PC2505
LPMT	040210R-MF	●	●	●	-
	040220R-MF	●	●	●	-
LPMW	040210R	●	-	●	●
	040220R	●	-	●	●
LPEW	040210R	●	-	●	●
	040220R	●	-	●	●

● : Stock item

Parts

Specification	Screw 	Wrench
Ø8~Ø10	FTKA01840	TW06S-A
Ø11~Ø21	FTKA01842	

HFMS1000 (Shank)

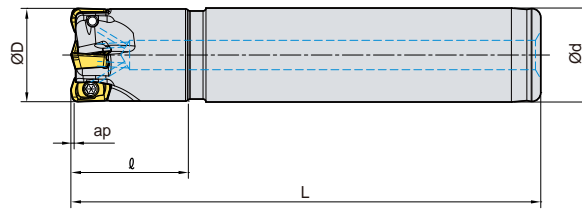

AA
13°
AR: -4°
RR: -6°~ -3°

(mm)

Designation			ØD	Ød	ℓ	L	ap	
HFMS	1015HR-4S12	4	15	12	20	80	0.4~0.5	0.07
	1015HR-4M12	4	15	12	25	105	0.4~0.5	0.09
	1015HR-4L12	4	15	12	40	120	0.4~0.5	0.11
	1016HR-4S16	4	16	16	20	80	0.4~0.5	0.11
	1016HR-4M16	4	16	16	25	105	0.4~0.5	0.14
	1016HR-4L16	4	16	16	40	120	0.4~0.5	0.16
	1017HR-4S16	4	17	16	20	80	0.4~0.5	0.11
	1017HR-4M16	4	17	16	25	105	0.4~0.5	0.15
	1017HR-4L16	4	17	16	40	120	0.4~0.5	0.17
	1018HR-4S16	4	18	16	20	80	0.4~0.5	0.11
	1018HR-4M16	4	18	16	25	105	0.4~0.5	0.15
	1018HR-4L16	4	18	16	40	120	0.4~0.5	0.17
	1019HR-4S16	4	19	16	20	80	0.4~0.5	0.12
	1019HR-4M16	4	19	16	25	105	0.4~0.5	0.16
	1019HR-4L16	4	19	16	40	120	0.4~0.5	0.18
	1020HR-4S20	4	20	20	20	80	0.4~0.5	0.17
	1020HR-4M20	4	20	20	25	105	0.4~0.5	0.22
	1020HR-4L20	4	20	20	40	120	0.4~0.5	0.26
	1020HR-5S20	5	20	20	20	80	0.4~0.5	0.17
	1020HR-5M20	5	20	20	25	105	0.4~0.5	0.23
1020HR-5L20	5	20	20	40	120	0.4~0.5	0.27	
1021HR-5S20	5	21	20	20	80	0.4~0.5	0.17	
1021HR-5M20	5	21	20	25	105	0.4~0.5	0.23	
1021HR-5L20	5	21	20	40	120	0.4~0.5	0.27	

Available Inserts



LPMT-MF



LPMW



LPEW

Designation	Usage	Coated			
		PC5300	PC5400	PC2510	PC2505
LPMT 040210R-MF 040220R-MF	Fine finishing	●	●	●	-
		●	●	●	-
LPMW 040210R 040220R	High hardness material machining	●	-	●	●
		●	-	●	●
LPEW 040210R 040220R	High hardness material machining	●	-	●	●
		●	-	●	●

●: Stock item

Parts

Specification	Screw 	Wrench
Ø8~Ø10	FTKA01840	TW06S-A
Ø11~Ø21	FTKA01842	

HFM

HFMM (Modular)

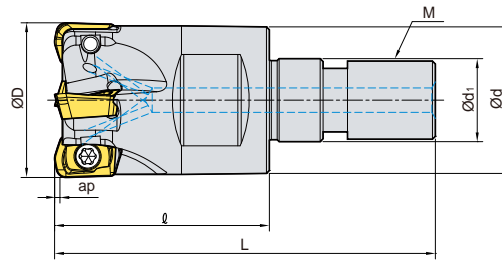

AA
13°
AR: -4°
RR: -14°~-3°

(mm)

Designation			ØD	Ød	Ød ₁	ℓ	L	M	ap	
HFMM	1008HR-M06	1	8	9.5	6.5	17	32	M06	0.4~0.5	0.01
	1010HR-M06	2	10	9.5	6.5	17	32	M06	0.4~0.5	0.01
	1011HR-M06	2	11	9.5	6.5	17	32	M06	0.4~0.5	0.01
	1012HR-M06	3	12	11	6.5	19	34	M6B	0.4~0.5	0.01
	1013HR-M06	3	13	11	6.5	19	34	M6B	0.4~0.5	0.01
	1016HR-M08	4	16	14.5	8.5	22	39	M08	0.4~0.5	0.03
	1017HR-M08	4	17	14.5	8.5	22	39	M08	0.4~0.5	0.03
	1020HR-M10	5	20	18	10.5	25	46	M10	0.4~0.5	0.06
	1021HR-M10	5	21	18	10.5	25	46	M10	0.4~0.5	0.06
	1025HR-M12	6	25	23	12.5	27	51	M12	0.4~0.5	0.11
	1026HR-M12	6	26	23	12.5	27	51	M12	0.4~0.5	0.11
	1030HR-M16	7	30	29	17	30	60	M16	0.4~0.5	0.17
	1032HR-M16	8	32	29	17	30	60	M16	0.4~0.5	0.18
	1033HR-M16	8	33	29	17	30	60	M16	0.4~0.5	0.18

Available Inserts



LPMT-MF



LPMW



LPEW

Designation	Usage	Coated			
		PC5300	PC5400	PC2510	PC2505
LPMT 040210R-MF 040220R-MF	Fine finishing	●	●	●	-
		●	●	●	-
LPMW 040210R 040220R	High hardness material machining	●	-	●	●
		●	-	●	●
LPEW 040210R 040220R	High hardness material machining	●	-	●	●
		●	-	●	●

● : Stock item

Parts

Specification	Screw 	Wrench
Ø8~Ø10	FTKA01840	TW06S-A
Ø11~Ø33	FTKA01842	

⇒ MAT (Steel Shank type)

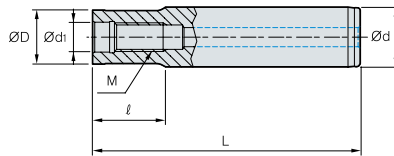

Fig. 1

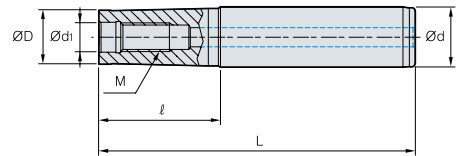

Fig. 2

(mm)

Designation		ØD	Ød	Ød ₁	ℓ	L	M	Fig
MAT-	M06-020-S10S	9.5	10	6.5	20	70	M06	1
	M6B-020-S12S	11.0	12	6.5	20	76	M06	1
	M6B-040-S12S	11.0	12	6.5	40	96	M06	1
	M08-020-S16S	14.5	16	8.5	20	80	M08	1
	M10-030-S20S	18.0	20	10.5	30	100	M10	1
	M12-030-S25S	22.5	25	12.5	29	110	M12	1
	M16-035-S32S	28.5	32	17.0	35	125	M16	1
	M06-040-S12T	9.5	12	6.5	40	96	M06	2
	M06-065-S16T	9.5	16	6.5	65	125	M06	2
	M6B-065-S16T	11.0	16	6.5	65	125	M06	2
	M6B-080-S16T	11.0	16	6.5	80	140	M06	2
	M08-040-S16T	14.5	16	8.5	40	100	M08	2
	M08-065-S16T	14.5	16	8.5	65	125	M08	2
	M08-080-S20T	14.5	20	8.5	80	150	M08	2
	M08-110-S25T	14.5	25	8.5	110	190	M08	2
	M10-050-S20T	18.0	20	10.5	50	120	M10	2
	M10-070-S20T	18.0	20	10.5	70	140	M10	2
	M10-090-S25T	18.0	25	10.5	90	170	M10	2
	M10-110-S25T	18.0	25	10.5	110	190	M10	2
	M10-130-S32T	18.0	32	10.5	130	220	M10	2
	M12-050-S25T	22.5	25	12.5	50	130	M12	2
	M12-070-S25T	22.5	25	12.5	70	150	M12	2
	M12-090-S25T	22.5	25	12.5	90	170	M12	2
	M12-110-S32T	22.5	32	12.5	110	200	M12	2
	M12-175-S40T	22.5	40	12.5	175	300	M12	2
	M16-055-S32T	28.5	32	17.0	55	145	M16	2
	M16-080-S32T	28.5	32	17.0	80	170	M16	2
	M16-120-S32T	28.5	32	17.0	120	210	M16	2
M16-175-S40T	28.5	40	17.0	175	300	M16	2	

- S : Straight Neck Adapter
- T : Taper Neck Adapter

HFM

⇒ MAT-C (Carbide Shank type)

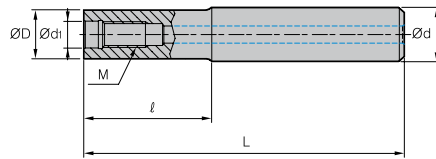

Fig. 1

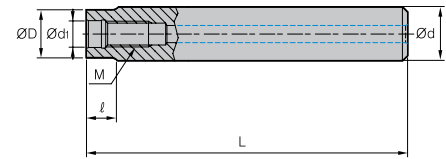
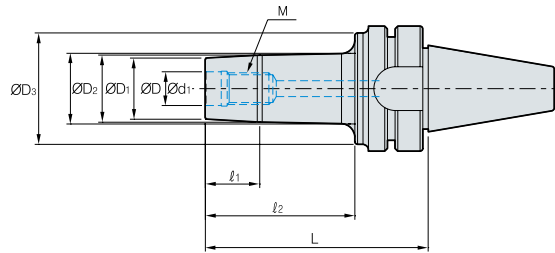

Fig. 1

(mm)

	Designation	ØD	Ød	Ød ₁	ℓ	L	M	Fig
MAT-	M06-030-S10S-C-80	9.5	10	6.5	30	80	M06	1
	M06-050-S10S-C-100	9.5	10	6.5	50	100	M06	1
	M06-080-S10S-C-130	9.5	10	6.5	80	130	M06	1
	M6B-030-S10S-C-80	11.0	10	6.5	30	80	M06	1
	M6B-050-S10S-C-100	11.0	10	6.5	50	100	M06	1
	M6B-080-S10S-C-130	11.0	10	6.5	80	130	M06	1
	M08-080-S16S-C	14.5	16	8.5	80	150	M08	1
	M08-110-S16S-C	14.5	16	8.5	110	180	M08	1
	M08-150-S16S-C	14.5	16	8.5	150	250	M08	1
	M08-010-S16S-C-150	14.5	16	8.5	10	150	M08	2
	M08-010-S16S-C-180	14.5	16	8.5	10	180	M08	2
	M08-010-S16S-C-250	14.5	16	8.5	10	250	M08	2
	M10-090-S20S-C	18.0	20	10.5	90	170	M10	1
	M10-110-S20S-C	18.0	20	10.5	110	200	M10	1
	M10-175-S20S-C	18.0	20	10.5	175	300	M10	1
	M10-010-S20S-C-170	18.0	20	10.5	10	170	M10	2
	M10-010-S20S-C-200	18.0	20	10.5	10	200	M10	2
	M10-010-S20S-C-300	18.0	20	10.5	10	300	M10	2
	M12-090-S25S-C	22.5	25	12.5	90	170	M12	1
	M12-110-S25S-C	22.5	25	12.5	110	200	M12	1
	M12-175-S25S-C	22.5	25	12.5	175	300	M12	1
	M12-015-S25S-C-170	22.5	25	12.5	15	170	M12	2
	M12-015-S25S-C-200	22.5	25	12.5	15	200	M12	2
	M12-015-S25S-C-300	22.5	25	12.5	15	300	M12	2
	M16-090-S32S-C	28.5	32	17.0	90	180	M16	1
	M16-120-S32S-C	28.5	32	17.0	120	210	M16	1
	M16-175-S32S-C	28.5	32	17.0	175	300	M16	1
	M16-020-S32S-C-180	28.5	32	17.0	20	180	M16	2
	M16-020-S32S-C-210	28.5	32	17.0	20	210	M16	2
	M16-020-S32S-C-300	28.5	32	17.0	20	300	M16	2

⇒ BT30 / BT40 / BT50



(mm)

Designation		ØD	ØD ₁	ØD ₂	ØD ₃	Ød ₁	l ₁	l ₂	L	M
BT30-	MAT-M06-053	11	11.7	13	30	6.5	5	21	53	M06*1.0
	MAT-M08-057	14.5	15.7	17.5	35	8.5	7	25	57	M08*1.25
	MAT-M10-062	18	19.7	24	38	10.5	7	30	62	M10*1.5
	MAT-M12-067	23	24.7	27.5	41	12.5	10	35	67	M12*1.75
	MAT-M16-067	29	31.7	33.5	41	17	10	35	67	M16*2.0
BT40-	MAT-M06-062	11	11.7	14	40	6.5	5	25	62	M06*1.0
	MAT-M06-077	11	11.7	14	40	6.5	5	40	77	M06*1.0
	MAT-M06-092	11	11.7	14	40	6.5	5	55	92	M06*1.0
	MAT-M08-067	14.5	15.7	19	44	8.5	7	30	67	M08*1.25
	MAT-M08-082	14.5	15.7	19	44	8.5	7	45	82	M08*1.25
	MAT-M08-097	14.5	15.7	19	44	8.5	7	60	97	M08*1.25
	MAT-M10-072	18	19.7	23	50	10.5	10	35	72	M10*1.5
	MAT-M10-087	18	19.7	23	50	10.5	10	50	87	M10*1.5
	MAT-M10-102	18	19.7	23	50	10.5	10	65	102	M10*1.5
	MAT-M12-077	23	24.7	30	55	12.5	10	40	77	M12*1.75
	MAT-M12-092	23	24.7	30	55	12.5	13	55	92	M12*1.75
	MAT-M12-107	23	24.7	30	55	12.5	13	70	107	M12*1.75
	MAT-M16-077	29	31.7	37	55	17	13	40	77	M16*2.0
	MAT-M16-092	29	31.7	37	55	17	13	55	92	M16*2.0
	MAT-M16-107	29	31.7	37	55	17	13	70	107	M16*2.0
	BT50-	MAT-M06-083	11	11.7	15	40	6.5	5	35	83
MAT-M06-098		11	11.7	15	40	6.5	5	50	98	M06*1.0
MAT-M06-113		11	11.7	15	40	6.5	5	65	113	M06*1.0
MAT-M08-088		14.5	15.7	20	45	8.5	7	40	88	M08*1.25
MAT-M08-103		14.5	15.7	20	45	8.5	7	55	103	M08*1.25
MAT-M08-118		14.5	15.7	20	45	8.5	7	70	118	M08*1.25
MAT-M10-093		18	19.7	25	55	10.5	10	45	93	M10*1.5
MAT-M10-113		18	19.7	25	55	10.5	10	65	113	M10*1.5
MAT-M10-128		18	19.7	25	55	10.5	10	80	128	M10*1.5
MAT-M12-103		23	24.7	33	65	12.5	10	55	103	M12*1.75
MAT-M12-118		23	24.7	33	65	12.5	13	70	118	M12*1.75
MAT-M12-133		23	24.7	33	65	12.5	13	85	133	M12*1.75
MAT-M16-103		29	31.7	41	85	17	13	55	103	M16*2.0
MAT-M16-118		29	31.7	41	85	17	13	70	118	M16*2.0
MAT-M16-133	29	31.7	41	85	17	13	85	133	M16*2.0	

⇒ HSK63A / HSK100A

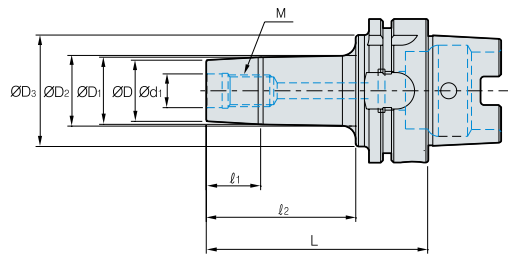

(mm)

Designation		ØD	ØD ₁	ØD ₂	ØD ₃	Ød ₁	ℓ ₁	ℓ ₂	L	M
HSK63A-	MAT-M06-061	11	11.7	27	40	6.5	5	25	61	M06*1.0
	MAT-M06-076	11	11.7	27	40	6.5	5	40	76	M06*1.0
	MAT-M06-091	11	11.7	27	40	6.5	5	55	91	M06*1.0
	MAT-M08-066	14.5	15.7	30.5	44	8.5	7	30	66	M08*1.25
	MAT-M08-081	14.5	15.7	30.5	44	8.5	7	45	81	M08*1.25
	MAT-M08-096	14.5	15.7	30.5	44	8.5	7	60	96	M08*1.25
	MAT-M10-071	18	19.7	34	50	10.5	10	35	71	M10*1.5
	MAT-M10-086	18	19.7	34	50	10.5	10	50	86	M10*1.5
	MAT-M10-101	18	19.7	34	50	10.5	10	65	101	M10*1.5
	MAT-M12-076	23	24.7	36.5	55	12.5	10	40	76	M12*1.75
	MAT-M12-091	23	24.7	36.5	55	12.5	13	55	91	M12*1.75
	MAT-M12-106	23	24.7	36.5	55	12.5	13	70	106	M12*1.75
	MAT-M16-076	29	31.7	38.5	55	17	13	40	76	M16*2.0
	MAT-M16-091	29	31.7	38.5	55	17	13	55	91	M16*2.0
MAT-M16-106	29	31.7	38.5	55	17	13	70	106	M16*2.0	
HSK100A-	MAT-M06-074	11	11.7	15	40	6.5	5	35	74	M06*1.0
	MAT-M06-089	11	11.7	15	40	6.5	5	50	89	M06*1.0
	MAT-M06-104	11	11.7	15	40	6.5	5	65	104	M06*1.0
	MAT-M08-079	14.5	15.7	20	45	8.5	7	40	79	M08*1.25
	MAT-M08-094	14.5	15.7	20	45	8.5	7	55	94	M08*1.25
	MAT-M08-109	14.5	15.7	20	45	8.5	7	70	109	M08*1.25
	MAT-M10-084	18	19.7	25	55	10.5	10	45	84	M10*1.5
	MAT-M10-104	18	19.7	25	55	10.5	10	65	104	M10*1.5
	MAT-M10-119	18	19.7	25	55	10.5	10	80	119	M10*1.5
	MAT-M12-094	23	24.7	33	65	12.5	10	55	94	M12*1.75
	MAT-M12-109	23	24.7	33	65	12.5	13	70	109	M12*1.75
	MAT-M12-124	23	24.7	33	65	12.5	13	85	124	M12*1.75
	MAT-M16-094	29	31.7	41	85	17	13	55	94	M16*2.0
	MAT-M16-109	29	31.7	41	85	17	13	70	109	M16*2.0
MAT-M16-124	29	31.7	41	85	17	13	85	124	M16*2.0	



Holystar B/D, 1350, Nambusunhwan-ro, Geumcheon-gu, Seoul, 08536, Korea
 Tel : +82-2-522-3181 Fax : +82-2-522-3184, +82-2-3474-4744 Web : www.korloy.com E-mail : export@korloy.com



620 Maple Avenue, Torrance, CA 90503, USA
 Tel : +1-310-782-3800 Toll Free : +1-888-711-0001 Fax : +1-310-782-3885
 www.korloyamerica.com E-mail : sales@korloy.us



Plot NO.415, Sector 8, IMT Manesar, Gurgaon 122051, Haryana, INDIA
 Tel : +91-124-4391790 Fax : +91-124-4050032
 www.korloyindia.com E-mail : sales.kip@korloy.com



Gablonz Str. 25-27, 61440 Oberursel, Germany
 Tel : +49-6171-277-83-0 Fax : +49-6171-277-83-59
 www.korloyeurope.com E-mail : sales@korloyeurope.com



Av. Aruana 280, conj.12, WLC, Alphaville, Barueri,
 CEP06460-010, SP, Brasil
 Tel : +55-11-4193-3810 E-mail : vendas@korloy.com