

# 5 | SCHLEIFEN GRINDING

FRÄSSTIFTE  
BURRS



5.1

☎ 733-836

FRÄSSTIFTE / LOCHSÄGEN FÜR SCHLÜSSELDIENSTE  
ROTARY BURRS / HOLE SAWS FOR LOCKSMITHS



5.2

☎ 837-840

SPEZIAL FRÄSSTIFTE  
SPECIAL BURRS



5.3

☎ 841-870

SETS · ZUBEHÖR  
SETS · ACCESSORIES



5.4

☎ 871-890

1



2



3



4



5



6



7



8



9



10

Index

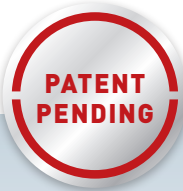

# HP-3 PRO/Performance 82

Die revolutionäre neue Universal-PRO Verzahnung



The revolutionary new Universal-PRO cutting style



**+82%** Bis zu 82% mehr Materialabtrag als unsere übliche HP-3 Universalverzahnung.  
\* Ist Ihnen der aggressive Materialabtrag/ Schruppen der neuen Universal-PRO Verzahnung zu stark, kann ergänzend auf unsere bewährte HP-3 Universalverzahnung zurückgegriffen werden.

**+82%** Up to 82% more material removal than our usual HP-3 Universal cutting style.  
\* If the aggressive material removal / roughing of the new Universal-PRO cut appears too strong for you, please use our proven HP-3 universal cut.

**HOHE STANDZEIT** Hohe Standzeit bei High-Performance.

**LONG TOOL LIFE** Long tool life comes with high performance.

**ANTI-VIBRATION** Nahezu vibrationsfreies und kontrolliertes arbeiten möglich, selbst bei extremen Schrupparbeiten.

**ANTI-VIBRATION** Almost vibration-free and controlled work even under tough roughing conditions possible.

**GREEN-TEC** Erhältlich in der neuesten GREEN-TEC Beschichtungs-Technologie, für nochmalige signifikante Standzeiterhöhung.

**GREEN-TEC** Available in the latest GREEN-TEC coating technology to further increase tool life

ANWENDUNG · APPLICATION							
Stahl Steel	Gehärteter Stahl Hardened steel	Edelstahl Stainless	Gusseisen Cast iron	Titan Titanium	Nickel Nickel	Kupfer, Kupferlegierungen Copper, copper alloys	Alu Alu

Unsere neue HP-3 PRO / Performance 82 ist eine Universalverzahnung für nahezu alle Materialien. Bitte beachten Sie, dass mit unseren Spezialverzahnungen durchaus noch höherer Materialabtrag/Standzeiten möglich sind, wie zum Beispiel:

Our new HP-3 PRO / Performance 82 is a universal cut for almost all materials. Please note that with our special cuts an even higher material removal / tool life is possible. See for example:

↓	↓	↓
<b>Spezialverzahnungen / special cuts</b>		
<b>HP-9</b> <span style="float: right;">☎ 808-814</span>	<b>HP-8</b> <span style="float: right;">☎ 800-806</span>	<b>HP-7</b> <span style="float: right;">☎ 784-791</span>
Speziell für Edelstahl. Extrem hohe Zerspanleistung Especially for stainless steel. Extremely high machining output.	Speziell für Stahl und Stahlguss. Extrem hohe Zerspanleistung Especially for steel and cast steel. Extremely high machining output	Speziell für NE-Metalle wie Alu, Kupfer, Messing sowie alle Kunststoffe Especially for non-ferrous materials such as Aluminum, copper, brass. Also for all kinds of plastics.

- 1
- 2
- 3
- 4
- 5
- 6
- 7
- 8
- 9
- 10

## HARTMETALL-FRÄSSTIFTE

Ähnlich DIN 8032

## TUNGSTEN CARBIDE BURRS

Similar DIN 8032



1



2



3



4



5



6



7



8



9



10

Index

**PATENT  
PENDING**

  
GERMAN  
QUALITY  
PRODUCT

5.1

KONTAKT | CONTACT

**KARNASCH PROFESSIONAL TOOLS<sup>®</sup>**  
INDUSTRIAL TOOLS DIVISION

Straße des Friedens 10  
D-15848 Tauche/OT Görzdorf  
mail@karnasch.tools

**+49 (0) 33675 - 7265-0**

KARNASCH ONLINESHOP

**JETZT FÜR SIE ONLINE!**  
NOW ONLINE FOR YOU!

<http://shop.karnasch.tools>



ONLINE



- 1
- 2
- 3
- 4
- 5
- 6
- 7
- 8
- 9
- 10

## HP-3 PRO / PERFORMANCE 82

BEST SELLER

☎ 744-751

neu  
new



Die revolutionäre neue Universal-PRO Verzahnung

The revolutionary new Universal-PRO cutting style



- Bis zu 82 % mehr Materialabtrag als unsere übliche HP-3 Universalverzahnung.
- Hohe Standzeit bei High-Performance.
- Nahezu vibrationsfreies und kontrolliertes arbeiten möglich, selbst bei extremen Schrupparbeiten.
- Erhältlich in der neuesten **GREEN-TEC** Beschichtungs-Technologie, für nochmalige signifikante Standzeit-erhöhung.
- Für alle Stahlsorten wie:
  - Gusseisen
  - Stahl <60 HRC
  - Edelstahl (INOX)
  - Nickelbasis und Titanlegierungen
  - Auch für Kupfer, Messing, Bronze.
- Up to 82 % more material removal than our usual HP-3 universal cutting style.
- Long tool life comes with high performance.
- Almost vibration-free and controlled work even under tough roughing conditions possible.
- Available in the latest **GREEN-TEC** coating technology for another significant increase in tool life.
- For all types of steel such as:
  - Cast iron
  - Steel <60 HRC
  - Stainless steel (INOX)
  - Nickel basis and titanium alloy
  - Also for copper, brass, bronze.

## HP-3

BEST SELLER

VALUETOOL

☎ 752-765



Die am meisten verwendete Universalverzahnung

The most widely used universal cutting style

- Hohe Zerspanleistung durch Kreuzverzahnung:
  - Ruhiger Lauf
  - Kurze Späne
- Für alle Stahlsorten wie:
  - Gusseisen
  - Stahl < 60 HRC
  - Edelstahl (INOX)
  - Nickelbasis- und Titanlegierungen
- Auch Kupfer, Messing, Bronze
- High cutting action through cross cutting style
  - Smooth operation
  - Short chips
- For use on all ferrous metals such as:
  - Cast iron
  - Steel < 60 HRC
  - Stainless steel (INOX)
  - Nickel basis and titanium alloy
- Also copper, brass, bronze

## HP-2

☎ 766-774



Die am meisten verwendete Einfachverzahnung

The most widely used single cutting style

- Hohe Zerspanleistung mit guter Oberflächengüte
- Für alle Stahlsorten wie:
  - Gusseisen
  - Stahl < 60 HRC
  - Edelstahl (INOX)
  - Nickelbasis- und Titanlegierungen
- Auch Kupfer, Messing, Bronze
- High cutting action with good surface finish
- For use on all ferrous metals such as:
  - Cast iron
  - Steel < 60 HRC
  - Stainless steel (INOX)
  - Nickel basis and titanium alloy
- Also copper, brass, bronze

## HP-6

☎ 776-782



Extrem grobe Kreuzverzahnung

Extremely rough cross cutting style

- Extrem hoher Materialabtrag (Schruppen)
- Für alle Stahlsorten wie:
  - Gusseisen
  - Stahl < 60 HRC
- Auch für Kupfer, Messing, Bronze
- Für den harten Schruppeinsatz wie z.B. auf Werften, Gießereien entwickelt.
- Extremely fast metal removal (roughing)
- For all ferrous metals, such as:
  - Cast iron
  - Steel < 60 HRC
- Also for copper, brass, bronze
- Developed for use in tough roughing conditions, such as, e.g., on shipyards, foundries.

## HP-7

☎ 784-791



Speziell für NE-Metalle wie Alu, Kupfer, Messing sowie alle Kunststoffe

Especially for non-ferrous materials such as Aluminum, copper, brass. Also for all kinds of plastics.

- Alulegierungen
- Leichtmetalle
- Weiche Buntmetalle (NE-Metalle)
- Kunststoffe
- Faserverstärkte Kunststoffe GFK/CFK
- Aluminum alloy
- Light metals
- Soft copper and copper alloys (non-ferrous metals)
- Plastics
- Fibre-reinforced plastic (GFK/CFK)

## Spezial-Frässtifte · Special burrs

☎ 841-844

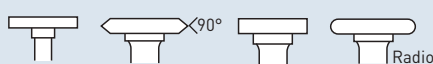

Scheibenform  
RIM shape

☎ 842

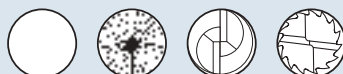

Frässtifte für GFK/CFK  
Fiberglass routers

☎ 843



Mini-Frässtifte Ø 1 + 1,5 mm  
Mini-burrs Ø 1 + 1,5 mm

☎ 844









Frässtifte + Bohrer für Schlüsseldienste  
Burrs + drills for locksmiths

☎ 838-840

## Kombinations-Frässtifte · Combination-burrs

☎ 845-864



<p><b>HP-1</b> <span style="float: right;">☎ 792-799</span></p> <p> Für Superlegierungen. Extrem robuste Kreuzverzahnung</p> <p>For super alloys. Extremely robust cross cutting style</p> <ul style="list-style-type: none"> <li>• Schlagunempfindlichkeit (Zahnausbrüche, Abplatzungen, Kopfbrüche werden minimiert)</li> <li>• Exzellente Kontrolle und Laufruhe</li> <li>• Mittlere bis hohe Zerspanleistung</li> <li>• Speziell für schwierigste Superlegierungen + Edelstähle wie: Titan, Inconel, Hastelloy, Waspaloy, Duplex, Amanox usw.</li> <li>• Anwendungsbeispiel: Bearbeitung von Flugzeug Turbinenschaufeln, Gasturbinen</li> <li>• Impact resistance (tooth breakages, chipping, head breakages are minimised)</li> <li>• Excellent control and quiet running</li> <li>• Medium to high cutting action</li> <li>• Especially for the most difficult super alloys + stainless steel, such as: Titanium, Inconel, Hastelloy, Waspaloy, Duplex, Amanox, etc.</li> <li>• Application example: Working aeroplane turbine blades, gas turbines</li> </ul>	<p><b>HP-8</b> <span style="float: right;">☎ 800-806</span></p> <p> Speziell für Stahl und Stahlguss. Extrem hohe Zerspanleistung</p> <p>Especially for steel and cast steel. Extremely high machining output</p> <ul style="list-style-type: none"> <li>• Bis zu 60% höhere Zerspanleistung im Vergleich zu herkömmlichen Kreuzverzahnungen.</li> <li>• Hohe Aggressivität erzeugt große Späne mit hervorragender Spanabfuhr.</li> <li>• Keine Anlauffarben am Werkstück durch geringe Wärmeentwicklung</li> <li>• Up to 60% higher machining output as compared to conventional cross cut.</li> <li>• High aggressiveness produces large chips with outstanding chip removal.</li> <li>• No annealing colours at the workpiece due to low heat development.</li> </ul>	<p><b>HP-9</b> <span style="float: right;">☎ 808-814</span></p> <p> Speziell für Edelstahl. Extrem hohe Zerspanleistung</p> <p>Especially for stainless steel. Extremely high machining output.</p> <ul style="list-style-type: none"> <li>• Extrem hohe Zerspanleistung und Standzeit für alle austenitischen, rost- und säurebeständigen Stähle.</li> <li>• Nickelbasis und Titanlegierungen (Drehzahl reduzieren um Funkenbildung zu vermeiden)</li> <li>• Hochwertige Oberflächengüte</li> <li>• Keine Anlauffarben am Werkstück durch geringe Wärmeentwicklung</li> <li>• Extremely high machining output and service life for all austenitic, rust- and acid-resilient steels.</li> <li>• Nickel basis and titanium alloy (reduce speed to avoid sparking)</li> <li>• High-quality surface.</li> <li>• No annealing colours at the workpiece due to low heat development.</li> </ul>
<p><b>HP-4</b> <span style="float: right;">☎ 816-823</span></p> <p> Feine Kreuzverzahnung</p> <p>Fine cross cutting style</p> <ul style="list-style-type: none"> <li>• Exzellente Kontrolle (auch an schwierig zugänglichen Stellen): Ruhiger Lauf · Kurze Späne · Gute Oberflächengüte</li> <li>• Mittlere Zerspanleistung</li> <li>• Für alle Stahlsorten wie:             <ul style="list-style-type: none"> <li>- Bis zu extra harten Stählen ca. 70 HRC</li> <li>- Gusseisen · Edelstahl (INOX)</li> <li>- Hochwarmfeste Werkstoffe wie z.B. Nickel-Basis + Kobalt Basislegierungen</li> </ul> </li> <li>• Excellent control (also at difficult to reach positions)             <ul style="list-style-type: none"> <li>- Smooth operation · Short chips</li> <li>- Good surface finish</li> </ul> </li> <li>• Medium cutting action</li> <li>• For all kinds of steel: Up to extra hard steel approx. 70 HRC · Cast iron · Stainless steel (INOX) · Heat-resistant substances, such as e.g. nickel based + cobalt based alloys</li> </ul>	<p><b>HP-5</b> <span style="float: right;">☎ 824-830</span></p> <p> Extrem feine Einfachverzahnung</p> <p>Extremely fine single cutting style</p> <ul style="list-style-type: none"> <li>• Exzellente Oberflächengüte</li> <li>• Vorzugsweise für feines Entgraten von allen Stahlsorten wie:             <ul style="list-style-type: none"> <li>- Bis zu extra harten Stählen ca. 70 HRC</li> <li>- Gusseisen · Edelstahl (INOX)</li> <li>- Hochwarmfeste Werkstoffe wie z.B. Nickel-Basis + Kobalt-Basis + Kobalt-Basis Legierungen</li> </ul> </li> <li>• Excellent surface finish</li> <li>• Preferred for fine deburring all ferrous metals, such as:             <ul style="list-style-type: none"> <li>- Up to extra hard steel approx. 70 HRC</li> <li>- Cast iron</li> <li>- Stainless steel (INOX)</li> <li>- Heat resistant substances, such as, e.g. nickel based + cobalt based alloys</li> </ul> </li> </ul>	<p><b>HP-11-Micro</b> <span style="float: right;">☎ 832-836</span></p> <p> Extrem feine Kreuzverzahnung</p> <p>Extremely fine cross cutting style</p> <ul style="list-style-type: none"> <li>• <b>Exzellent für die:</b> Feinbearbeitung · Extrem feine Putzarbeiten · Korrekturen im Werkzeug- und Formenbau · Schleifen/Schärfen von Schnittwerkzeugen</li> <li>• <b>Eigenschaften:</b> Gutes Abtragverhalten · Vibrationsarm · Exzellente Kontrolle/Führung im Handeinsatz · Hohe Oberflächengüte</li> <li>• <b>Vorteile:</b> Es können nahezu alle Werkstoffe bis zu einer Härte von 70 HRC bearbeitet werden. <b>In diesem Bereich werden üblicherweise Keramik-Schleifstifte verwendet.</b> Die neue Micro-Verzahnung garantiert:             <ul style="list-style-type: none"> <li>- Keine Geometrieänderung durch Abnutzung/Verschleiß gegenüber Schleifstifte.</li> <li>- Wesentlich höheren Materialabtrag sowie Standzeit gegenüber Schleifstifte</li> </ul> </li> </ul> <p>English text see page 832</p>

Druckluftgeradschleifer + Zubehör · Pneumatic straight grinder + accessories ☎ 1175-1207



Sets + Displays · Sets + Displays ☎ 871-890

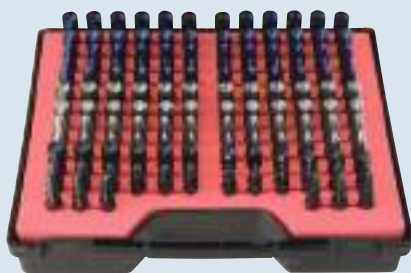

Seite / Page 890



Seite / Page 883/885



Seite / Page 871-890

Technische Daten · Technical data ☎ 1395



- 1
- 2
- 3
- 4
- 5
- 6
- 7
- 8
- 9
- 10

## HP-3 PRO

neu  
new



BEST SELLER

744-751

Die revolutionäre neue Universal-PRO Verzahnung  
The revolutionary new Universal-PRO cutting style

PATENT PENDING

Lagerartikel  
Stockrange

### ANWENDUNG · APPLICATION

 Stahl Steel	 Gehärteter Stahl Hardened steel	 Edelstahl Stainless	 Gusseisen Cast iron	 Titan Titanium	 Cermet Cermet	 Nickel Nickel	 Kupfer, Kupferlegierungen Copper, copper alloys	 Alu Alu	 Kunststoffe GFK/CFK Plastics GRP/CRP
✓	✓	✓	✓	✓	✓	✓	✓	✓	✓

✓ OPTIMAL  
OPTIMAL  
✓ GUT  
GOOD

- Bis zu 82 % mehr Materialabtrag als unsere übliche HP-3 Universalverzahnung.
- Hohe Standzeit bei High-Performance.
- Nahezu vibrationsfreies und kontrolliertes arbeiten möglich, selbst bei extremen Schrubarbeiten.
- Erhältlich in der neuesten GREEN-TEC Beschichtungs-Technologie, für nochmalige signifikante Standzeiterhöhung.
- Für alle Stahlsorten wie:
  - Gusseisen · Stahl <60 HRC · Edelstahl (INOX)
  - Nickelbasis und Titanlegierungen
  - Auch für Kupfer, Messing, Bronze.
- Up to 82 % more material removal than our usual HP-3 universal cutting style.
- Long tool life comes with high performance.
- Almost vibration-free and controlled work even under tough roughing conditions possible.
- Available in the latest GREEN-TEC coating technology for another significant increase in tool life.
- For all types of steel such as:
  - Cast iron · Steel <60 HRC · Stainless steel (INOX)
  - Nickel basis and titanium alloy
  - Also for copper, brass, bronze.

## HP-3



BEST SELLER

VALUETOOL

752-765

Die am meisten verwendete Universalverzahnung  
The most widely used universal cutting style

Lagerartikel  
Stockrange

### ANWENDUNG · APPLICATION

 Stahl Steel	 Gehärteter Stahl Hardened steel	 Edelstahl Stainless	 Gusseisen Cast iron	 Titan Titanium	 Cermet Cermet	 Nickel Nickel	 Kupfer, Kupferlegierungen Copper, copper alloys	 Alu Alu	 Kunststoffe GFK/CFK Plastics GRP/CRP
✓	✓	✓	✓	✓	✓	✓	✓	✓	✓

✓ OPTIMAL  
OPTIMAL  
✓ GUT  
GOOD

- Hohe Zerspanleistung durch Kreuzverzahnung:
  - Ruhiger Lauf
  - Kurze Späne
- Für alle Stahlsorten wie:
  - Gusseisen
  - Stahl < 60 HRC
  - Edelstahl (INOX)
  - Nickelbasis- und Titanlegierungen
- Auch Kupfer, Messing, Bronze
- High cutting action through cross cutting style
  - Smooth operation
  - Short chips
- For use on all ferrous metals such as:
  - Cast iron
  - Steel < 60 HRC
  - Stainless steel (INOX)
  - Nickel basis and titanium alloy
- Also copper, brass, bronze

## HP-2



766-774

Die am meisten verwendete Einfachverzahnung  
The most widely used single cutting style

Lagerartikel  
Stockrange

### ANWENDUNG · APPLICATION

 Stahl Steel	 Gehärteter Stahl Hardened steel	 Edelstahl Stainless	 Gusseisen Cast iron	 Titan Titanium	 Cermet Cermet	 Nickel Nickel	 Kupfer, Kupferlegierungen Copper, copper alloys	 Alu Alu	 Kunststoffe GFK/CFK Plastics GRP/CRP
✓	✓	✓	✓	✓	✓	✓	✓	✓	✓

✓ OPTIMAL  
OPTIMAL  
✓ GUT  
GOOD

- Hohe Zerspanleistung mit guter Oberflächengüte
- Für alle Stahlsorten wie:
  - Gusseisen
  - Stahl < 60 HRC
  - Edelstahl (INOX)
  - Nickelbasis- und Titanlegierungen
- Auch Kupfer, Messing, Bronze
- High cutting action with good surface finish
- For use on all ferrous metals such as:
  - Cast iron
  - Steel < 60 HRC
  - Stainless steel (INOX)
  - Nickel basis and titanium alloy
- Also copper, brass, bronze

# HP-3 PRO

Lagerprogramm + Katalogseiten • Stockrange + catalogue pages

ZYA <b>A</b>	ZYB <b>B</b>	WRC <b>C</b>	KUD <b>D</b>	TRE <b>E</b>	RBF <b>F</b>	SPG <b>G</b>	- <b>H</b>	KEL <b>L</b>	SKM <b>M</b>
Art. 11 6090 Art. 11 4090	Art. 11 6091 Art. 11 4091	Art. 11 6092 Art. 11 4092	Art. 11 6093 Art. 11 4093	Art. 11 6094 Art. 11 4094	Art. 11 6095 Art. 11 4095	Art. 11 6096 Art. 11 4096	Art. 11 6097 Art. 11 4097	Art. 11 6098 Art. 11 4098	Art. 11 6099 Art. 11 4099
747	747	748	748	749	749	750	750	751	751
Zylinder Cylinder	Zylinder + Stirnverzahnung Cylinder + end cut	Walzenrund- form Ball nosed cylinder	Kugel Ball	Tropfen Oval	Rundbogen Ball nosed tree	Spitzbogen Tree	Flamme Flame	Rundkegel Ball nosed cone	Spitzkegel Cone

# HP-3

Lagerprogramm + Katalogseiten • Stockrange + catalogue pages

ZYA <b>A</b>	ZYB <b>B</b>	ZYA <b>C</b>	WRC <b>D</b>	KUD <b>E</b>	TRE <b>F</b>	RBF <b>G</b>	SPG <b>H</b>	- <b>L</b>	KEL <b>M</b>	SKM <b>N</b>	WKN <b>J</b>	KSJ <b>K</b>	KSK <b>K</b>
Art. 11 5001 Art. 11 3001	Art. 11 5011 Art. 11 3011	Art. 11 6010 Art. 11 4010	Art. 11 5021 Art. 11 3021	Art. 11 5031 Art. 11 3031	Art. 11 5041 Art. 11 3041	Art. 11 5051 Art. 11 3051	Art. 11 5061 Art. 11 3061	Art. 11 5071 Art. 11 3071	Art. 11 5081 Art. 11 3081	Art. 11 5091 Art. 11 3091	Art. 11 5096 Art. 11 3096	Art. 11 5101 Art. 11 3101	Art. 11 5111 Art. 11 3111
754	755	757	758	759	760	761	762	763	763	764	764	765	765
Zylinder Cylinder	Zylinder + Stirn- verzahnung Cylinder + end cut	Zylinder- Radius Cylinder- Radius	Walzenrund- form Ball nosed cylinder	Kugel Ball	Tropfen Oval	Rundbogen Ball nosed tree	Spitzbogen Tree	Flamme Flame	Rundkegel Ball nosed cone	Spitzkegel Cone	Winkel Inverted cone	Kegel 60° Countersink 60°	Kegel 90° Countersink 90°

# HP-2

Lagerprogramm + Katalogseiten • Stockrange + catalogue pages

ZYA <b>A</b>	ZYB <b>B</b>	WRC <b>C</b>	KUD <b>D</b>	TRE <b>E</b>	RBF <b>F</b>	SPG <b>G</b>	- <b>H</b>	KEL <b>L</b>	SKM <b>M</b>	WKN <b>N</b>	KSJ <b>J</b>	KSK <b>K</b>
Art. 11 5000 Art. 11 3000	Art. 11 5010 Art. 11 3010	Art. 11 5020 Art. 11 3020	Art. 11 5030 Art. 11 3030	Art. 11 5040 Art. 11 3040	Art. 11 5050 Art. 11 3050	Art. 11 5060 Art. 11 3060	Art. 11 5070 Art. 11 3070	Art. 11 5080 Art. 11 3080	Art. 11 5090 Art. 11 3090	Art. 11 5099 Art. 11 3099	Art. 11 5100 Art. 11 3100	Art. 11 5110 Art. 11 3110
768	768	769	769	770	770	771	771	772	772	773	773	774
Zylinder Cylinder	Zylinder + Stirn- verzahnung Cylinder + end cut	Walzenrund- form Ball nosed cylinder	Kugel Ball	Tropfen Oval	Rundbogen Ball nosed tree	Spitzbogen Tree	Flamme Flame	Rundkegel Ball nosed cone	Spitzkegel Cone	Winkel Inverted cone	Kegel 60° Countersink 60°	Kegel 90° Countersink 90°



- 1
- 2
- 3
- 4
- 5
- 6
- 7
- 8
- 9
- 10

# HP-6

Extrem grobe Kreuzverzahnung  
Extremely rough cross cutting style

Lagerartikel  
Stockrange

## ANWENDUNG · APPLICATION



776-782

 Stahl Steel	 Gehärteter Stahl Hardened steel	 Edelstahl Stainless	 Gusseisen Cast iron	 Titan Titanium	 Cermet Cermet	 Nickel Nickel	 Kupfer, Kupferlegierungen Copper, copper alloys	 Alu Alu	 Kunststoffe GFK/CFK Plastics GRP/CRP
✓		✓	✓	✓		✓	✓		✓

- Extrem hoher Materialabtrag (Schruppen)
  - Für alle Stahlsorten wie:
    - Gusseisen
    - Stahl < 60 HRC
  - Auch für Kupfer, Messing, Bronze
  - Für den harten Schruppeinsatz wie z.B. auf Werften, Gießereien entwickelt.
- Extremely fast metal removal (roughing)
  - For all ferrous metals, such as:
    - Cast iron
    - Steel < 60 HRC
  - Also for copper, brass, bronze
  - Developed for use in tough roughing conditions, such as, e.g., on shipyards, foundries.

✓ OPTIMAL  
✓ OPTIMAL  
✓ GUT  
✓ GOOD

# HP-7

Speziell für NE-Metalle wie Alu, Kupfer, Messing sowie alle Kunststoffe  
Especially for non-ferrous materials such as Aluminum, copper, brass.  
Also for all kinds of plastics.

Lagerartikel  
Stockrange

## ANWENDUNG · APPLICATION



784-791

 Stahl Steel	 Gehärteter Stahl Hardened steel	 Edelstahl Stainless	 Gusseisen Cast iron	 Titan Titanium	 Cermet Cermet	 Nickel Nickel	 Kupfer, Kupferlegierungen Copper, copper alloys	 Alu Alu	 Kunststoffe GFK/CFK Plastics GRP/CRP
								✓	✓

- Alulegierungen
  - Leichtmetalle
  - Weiche Buntmetalle (NE-Metalle)
  - Kunststoffe
  - Faserverstärkte Kunststoffe GFK/CFK
- Aluminum alloy
  - Light metals
  - Soft copper and copper alloys (non-ferrous metals)
  - Plastics
  - Fibre-reinforced plastic (GFK/CFK)

✓ OPTIMAL  
✓ OPTIMAL  
✓ GUT  
✓ GOOD

# HP-1

Für Superlegierungen. Extrem robuste Kreuzverzahnung  
For super alloys. Extremely robust cross cutting style

Lagerartikel  
Stockrange

## ANWENDUNG · APPLICATION



792-799

 Stahl Steel	 Gehärteter Stahl Hardened steel	 Edelstahl Stainless	 Gusseisen Cast iron	 Titan Titanium	 Cermet Cermet	 Nickel Nickel	 Kupfer, Kupferlegierungen Copper, copper alloys	 Alu Alu	 Kunststoffe GFK/CFK Plastics GRP/CRP
✓	✓	✓		✓		✓			✓

- Schlagunempfindlichkeit (Zahnausbrüche, Abplatzungen, Kopfbrüche werden minimiert)
  - Exzellente Kontrolle und Laufruhe
  - Mittlere bis hohe Zerspanleistung
  - Speziell für schwierigste Superlegierungen + Edelstähle wie: Titan, Inconel, Hastelloy, Waspaloy, Duplex, Amanox usw.  
Anwendungsbeispiel: Bearbeitung von Flugzeug Turbinenschaufeln, Gasturbinen
- Impact resistance (tooth breakages, chipping, head breakages are minimised)
  - Excellent control and quiet running
  - Medium to high cutting action
  - Especially for the most difficult super alloys + stainless steel, such as: Titanium, Inconel, Hastelloy, Waspaloy, Duplex, Amanox, etc.  
Application example: Working aeroplane turbine blades, gas turbines

✓ OPTIMAL  
✓ OPTIMAL  
✓ GUT  
✓ GOOD















# HP-6

Lagerprogramm + Katalogseiten • Stockrange + catalogue pages

ZYA	ZYB	WRC	KUD	TRE	RBF	SPG	-	KEL	SKM
A	B	C	D	E	F	G	H	L	M
Art. 11 5004 Art. 11 5004	Art. 11 5014 Art. 11 3014	Art. 11 5024 Art. 11 3024	Art. 11 5034 Art. 11 3034	Art. 11 5044 Art. 11 3044	Art. 11 5054 Art. 11 3054	Art. 11 5064 Art. 11 3064	Art. 11 5074 Art. 11 3074	Art. 11 5084 Art. 11 3084	Art. 11 5094 Art. 11 3094
	 								
778	778	779	779	780	780	781	781	782	782
Zylinder Cylinder	Zylinder + Stirn- verzahnung Cylinder + end cut	Walzenrund- form Ball nosed cylinder	Kugel Ball	Tropfen Oval	Rundbogen Ball nosed tree	Spitzbogen Tree	Flamme Flame	Rundkegel Ball nosed cone	Spitzkegel Cone











# HP-7

Lagerprogramm + Katalogseiten • Stockrange + catalogue pages

ZYA	ZYB	WRC	KUD	TRE	RBF	SPG	-	KEL	SKM	MINI-ALU
A	B	C	D	E	F	G	H	L	M	
Art. 11 5005 Art. 11 3005	Art. 11 5015 Art. 11 3015	Art. 11 5025 Art. 11 3025	Art. 11 5035 Art. 11 3035	Art. 11 5045 Art. 11 3045	Art. 11 5055 Art. 11 3055	Art. 11 5065 Art. 11 3065	Art. 11 5075 Art. 11 3075	Art. 11 5085 Art. 11 3085	Art. 11 5095 Art. 11 3095	
	 									
786	786	787	787	788	788	789	789	790	790	791
Zylinder Cylinder	Zylinder + Stirn- verzahnung Cylinder + end cut	Walzenrund- form Ball nosed cylinder	Kugel Ball	Tropfen Oval	Rundbogen Ball nosed tree	Spitzbogen Tree	Flamme Flame	Rundkegel Ball nosed cone	Spitzkegel Cone	Minifrässtifte in feiner Aluverzahnung Mini-burrs in Alu cutting style

# HP-1

Lagerprogramm + Katalogseiten • Stockrange + catalogue pages

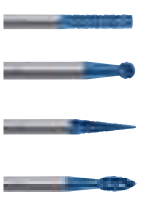
ZYA	ZYB	WRC	KUD	TRE	RBF	SPG	-	KEL	SKM	Ø 3 mm
A	B	C	D	E	F	G	H	L	M	
Art. 11 5007 Art. 11 3007	Art. 11 5017 Art. 11 3017	Art. 11 5027 Art. 11 3027	Art. 11 5037 Art. 11 3037	Art. 11 5047 Art. 11 3047	Art. 11 5057 Art. 11 3057	Art. 11 5067 Art. 11 3067	Art. 11 5077 Art. 11 3077	Art. 11 5087 Art. 11 3087	Art. 11 5097 Art. 11 3097	
	 									
794	794	795	795	796	796	797	797	798	798	799
Zylinder Cylinder	Zylinder + Stirn- verzahnung Cylinder + end cut	Walzenrund- form Ball nosed cylinder	Kugel Ball	Tropfen Oval	Rundbogen Ball nosed tree	Spitzbogen Tree	Flamme Flame	Rundkegel Ball nosed cone	Spitzkegel Cone	Ø 3 mm, Schaft 3 mm, für Superlegierungen! Ø 3 mm, Shank 3 mm, for super alloys!



- 1
- 2
- 3
- 4
- 5
- 6
- 7
- 8
- 9
- 10

# HP-8

Speziell für Stahl und Stahlguss. Extrem hohe Zerspanleistung  
Especially for steel and cast steel. Extremely high machining output

Lagerartikel  
Stockrange

## ANWENDUNG · APPLICATION



800-806

Stahl Steel	Gehärteter Stahl Hardened steel	Edelstahl Stainless	Gusseisen Cast iron	Titan Titanium	Cermet Cermet	Nickel Nickel	Kupfer, Kupfer- legierungen Copper, copper alloys	Alu Alu	Kunststoffe GFK/CFK Plastics GRP/CRP
✓	✓		✓						

- Bis zu 60% höhere Zerspanleistung im Vergleich zu herkömmlichen Kreuzverzahnungen.
- Hohe Aggressivität erzeugt große Späne mit hervorragender Spanabfuhr.
- Keine Anlauffarben am Werkstück durch geringe Wärmeentwicklung

- Up to 60% higher machining output as compared to conventional cross cut.
- High aggressiveness produces large chips with outstanding chip removal.
- No annealing colours at the workpiece due to low heat development.

- ✓ OPTIMAL OPTIMAL
- ✓ GUT GOOD

# HP-9

Speziell für Edelstahl. Extrem hohe Zerspanleistung  
Especially for stainless steel. Extremely high machining output.

Lagerartikel  
Stockrange

## ANWENDUNG · APPLICATION



808-814

Stahl Steel	Gehärteter Stahl Hardened steel	Edelstahl Stainless	Gusseisen Cast iron	Titan Titanium	Cermet Cermet	Nickel Nickel	Kupfer, Kupfer- legierungen Copper, copper alloys	Alu Alu	Kunststoffe GFK/CFK Plastics GRP/CRP
		✓		✓					

- Extrem hohe Zerspanleistung und Standzeit für alle austenitischen, rost- und säurebeständigen Stähle.
- Nickelbasis und Titanlegierungen (Drehzahl reduzieren um Funkenbildung zu vermeiden)
- Hochwertige Oberflächengüte
- Keine Anlauffarben am Werkstück durch geringe Wärmeentwicklung

- Extremely high machining output and service life for all austenitic, rust- and acid-resilient steels.
- Nickel basis and titanium alloy (reduce speed to avoid sparking)
- High-quality surface.
- No annealing colours at the workpiece due to low heat development.

- ✓ OPTIMAL OPTIMAL
- ✓ GUT GOOD

# HP-4

Feine Kreuzverzahnung  
Fine cross cutting style

Lagerartikel  
Stockrange

## ANWENDUNG · APPLICATION

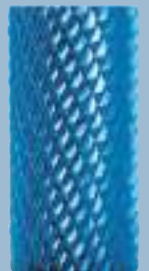

816-823

Stahl Steel	Gehärteter Stahl Hardened steel	Edelstahl Stainless	Gusseisen Cast iron	Titan Titanium	Cermet Cermet	Nickel Nickel	Kupfer, Kupfer- legierungen Copper, copper alloys	Alu Alu	Kunststoffe GFK/CFK Plastics GRP/CRP
✓	✓	✓	✓	✓	✓	✓	✓		







- Exzellente Kontrolle (Auch an schwierig zugänglichen Stellen)
  - Ruhiger Lauf
  - Kurze Späne
  - Gute Oberflächengüte
- Mittlere Zerspanleistung
- Für alle Stahlsorten wie:
  - Bis zu extra harten Stählen ca. 70 HRC
  - Gusseisen
  - Edelstahl (INOX)
  - Hochwärmefeste Werkstoffe wie z.B. Nickel-Basis + Kobalt Basislegierungen

- Excellent control (also at difficult to reach positions)
  - Smooth operation
  - Short chips
  - Good surface finish
- Medium cutting action
- For all kinds of steel:
  - Up to extra hard steel approx. 70 HRC
  - Cast iron
  - Stainless steel (INOX)
  - Heat-resistant substances, such as e.g. nickel based + cobalt based alloys

- ✓ OPTIMAL OPTIMAL
- ✓ GUT GOOD

# HP-8

Lagerprogramm + Katalogseiten • Stockrange + catalogue pages

ZYA	ZYB	WRC	KUD	TRE	RBF	SPG	-	KEL	SKM
A	B	C	D	E	F	G	H	L	M
Art. 11 6041 Art. 11 4041	Art. 11 6042 Art. 11 4042	Art. 11 6043 Art. 11 4043	Art. 11 6044 Art. 11 4044	Art. 11 6045 Art. 11 4045	Art. 11 6046 Art. 11 4046	Art. 11 6047 Art. 11 4047	Art. 11 6048 Art. 11 4048	Art. 11 6049 Art. 11 4049	Art. 11 6050 Art. 11 4050
									
802	802	803	803	804	804	805	805	806	806
Zylinder Cylinder	Zylinder + Stirn- verzahnung Cylinder + end cut	Walzenrund- form Ball nosed cylinder	Kugel Ball	Tropfen Oval	Rundbogen Ball nosed tree	Spitzbogen Tree	Flamme Flame	Rundkegel Ball nosed cone	Spitzkegel Cone











# HP-9

Lagerprogramm + Katalogseiten • Stockrange + catalogue pages

ZYA	ZYB	WRC	KUD	TRE	RBF	SPG	-	KEL	SKM
A	B	C	D	E	F	G	H	L	M
Art. 11 6031 Art. 11 4031	Art. 11 6032 Art. 11 4032	Art. 11 6033 Art. 11 4033	Art. 11 6034 Art. 11 4034	Art. 11 6035 Art. 11 4035	Art. 11 6036 Art. 11 4036	Art. 11 6037 Art. 11 4037	Art. 11 6038 Art. 11 4038	Art. 11 6039 Art. 11 4039	Art. 11 6040 Art. 11 4040
									
810	810	811	811	812	812	813	813	814	814
Zylinder Cylinder	Zylinder + Stirn- verzahnung Cylinder + end cut	Walzenrund- form Ball nosed cylinder	Kugel Ball	Tropfen Oval	Rundbogen Ball nosed tree	Spitzbogen Tree	Flamme Flame	Rundkegel Ball nosed cone	Spitzkegel Cone

# HP-4

Lagerprogramm + Katalogseiten • Stockrange + catalogue pages

ZYA	ZYB	WRC	KUD	TRE	RBF	SPG	-	KEL	SKM	WKN
A	B	C	D	E	F	G	H	L	M	N
Art. 11 5002 Art. 11 3002	Art. 11 5012 Art. 11 3012	Art. 11 5022 Art. 11 3022	Art. 11 5032 Art. 11 3032	Art. 11 5042 Art. 11 3042	Art. 11 5052 Art. 11 3052	Art. 11 5062 Art. 11 3062	Art. 11 5072 Art. 11 3072	Art. 11 5082 Art. 11 3082	Art. 11 5092 Art. 11 3092	Art. 11 5098 Art. 11 3098
										
818	818	819	820	820	821	821	822	822	823	823
Zylinder Cylinder	Zylinder + Stirn- verzahnung Cylinder + end cut	Walzenrund- form Ball nosed cylinder	Kugel Ball	Tropfen Oval	Rundbogen Ball nosed tree	Spitzbogen Tree	Flamme Flame	Rundkegel Ball nosed cone	Spitzkegel Cone	Winkel Inverted cone



- 1
- 2
- 3
- 4
- 5
- 6
- 7
- 8
- 9
- 10

# HP-5

Extrem feine Einfachverzahnung  
Extremely fine single cutting style

Lagerartikel  
Stockrange



824-830

## ANWENDUNG · APPLICATION

Stahl Steel	Gehärteter Stahl Hardened steel	Edelstahl Stainless	Gusseisen Cast iron	Titan Titanium	Cermet Cermet	Nickel Nickel	Kupfer, Kupfer- legierungen Copper, copper alloys	Alu Alu	Kunststoffe GFK/CFK Plastics GRP/CRP
✓	✓	✓	✓	✓	✓	✓	✓		✓

- Exzellente Oberflächengüte
- Vorzugsweise für feines Entgraten von allen Stahlsorten wie:
  - Bis zu extra harten Stählen ca. 70 HRC
  - Gusseisen
  - Edelstahl (INOX)
  - Hochwarmfeste Werkstoffe wie z.B. Nickel-Basis + Kobalt-Basis + Kobalt-Basis Legierungen

- Excellent surface finish
- Preferred for fine deburring all ferrous metals, such as:
  - Up to extra hard steel approx. 70 HRC
  - Cast iron
  - Stainless steel (INOX)
  - Heat resistant substances, such as, e.g. nickel based + cobalt based alloys

✓ OPTIMAL  
OPTIMAL  
✓ GUT  
GOOD

# HP-11

Extrem feine Kreuzverzahnung  
Extremely fine cross cutting style

Lagerartikel  
Stockrange



832-836

## ANWENDUNG · APPLICATION

Stahl Steel	Gehärteter Stahl Hardened steel	Edelstahl Stainless	Gusseisen Cast iron	Titan Titanium	Cermet Cermet	Nickel Nickel	Kupfer, Kupfer- legierungen Copper, copper alloys	Alu Alu	Kunststoffe GFK/CFK Plastics GRP/CRP
✓	✓	✓	✓	✓	✓	✓	✓		✓

- **Exzellente für die:**
  - Feinbearbeitung
  - Extrem feine Putzarbeiten
  - Korrekturen im Werkzeug- und Formenbau
  - Schleifen/Schärfen von Schnittwerkzeugen
- **Eigenschaften:**
  - Gutes Abtragverhalten
  - Vibrationsarm
  - Exzellente Kontrolle/Führung im Handeinsatz
  - Hohe Oberflächengüte
- **Vorteile:**
  - Es können nahezu alle Werkstoffe bis zu einer Härte von 70 HRC bearbeitet werden.
  - **In diesem Bereich werden üblicherweise Keramik-Schleifstifte verwendet.**
- Die neue Micro-Verzahnung garantiert:
  - Keine Geometrieänderung durch Abnutzung/ Verschleiß gegenüber Schleifstifte.
  - Wesentlich höheren Materialabtrag sowie Standzeit gegenüber Schleifstifte

- **Excellent for:**
  - Finishing
  - Extremely fine cleaning work
  - Corrections in tool and mould construction
  - Grinding/sharpening of cutting tools
- **Characteristics:**
  - Good stock removal
  - Low vibrations
  - Excellent control and guidance under handheld conditions.
  - High surface quality
- **Advantages:**
  - Micro-cut can be used for work on almost all materials up to a hardness of 70 HRC.
  - **In this area usually mounted points are used.**
  - Unlike with mounted points, there is no change in geometry due to wear and tear.
  - Unlike with mounted points, there is much higher performance, surface quality and lifetime

✓ OPTIMAL  
OPTIMAL  
✓ GUT  
GOOD

# HP-5

Lagerprogramm + Katalogseiten • Stockrange + catalogue pages

ZYA	ZYB	WRC	KUD	TRE	RBF	SPG	-	KEL	SKM
A	B	C	D	E	F	G	H	L	M
Art. 11 5003 Art. 11 3003	Art. 11 5013 Art. 11 3013	Art. 11 5023 Art. 11 3023	Art. 11 5033 Art. 11 3033	Art. 11 5043 Art. 11 3043	Art. 11 5053 Art. 11 3053	Art. 11 5063 Art. 11 3063	Art. 11 5073 Art. 11 3073	Art. 11 5083 Art. 11 3083	Art. 11 5093 Art. 11 3093
	 								
826	826	827	827	828	828	829	829	830	830
Zylinder Cylinder	Zylinder + Stirn- verzahnung Cylinder + end cut	Walzenrund- form Ball nosed cylinder	Kugel Ball	Tropfen Oval	Rundbogen Ball nosed tree	Spitzbogen Tree	Flamme Flame	Rundkegel Ball nosed cone	Spitzkegel Cone

# HP-11

Lagerprogramm + Katalogseiten • Stockrange + catalogue pages

ZYA	ZYB	WRC	KUD	RBF	SPG
A	B	C	D	F	G
Art. 11 6080 Art. 11 4080	Art. 11 6081 Art. 11 4081	Art. 11 6082 Art. 11 4082	Art. 11 6083 Art. 11 4083	Art. 11 6084 Art. 11 4084	Art. 11 6085 Art. 11 4085
	 				
834	834	835	835	836	836
Zylinder Cylinder	Zylinder + Stirnverzahnung Cylinder + end cut	Walzenrundform Ball nosed cylinder	Kugel Ball	Rundbogen Ball nosed tree	Spitzbogen Tree

- 1 
- 2 
- 3 
- 4 
- 5 
- 6 
- 7 
- 8 
- 9 
- 10 

## HP-3 PRO

## Die revolutionäre neue Universal-PRO Verzahnung The revolutionary new Universal-PRO cutting style



- 1
- 2
- 3
- 4
- 5
- 6
- 7
- 8
- 9
- 10

### ANWENDUNG · APPLICATION

Stahl Steel	Gehärteter Stahl Hardened steel	Edelstahl Stainless	Gusseisen Cast iron	Titan Titanium	Cermet Cermet	Nickel Nickel	Kupfer, Kupferlegierungen Copper, copper alloys	Alu Alu	Kunststoffe GFK/CFK Plastics GRP/CRP
✓	✓	✓	✓	✓		✓	✓	✓	

- ✓ OPTIMAL OPTIMAL
- ✓ GUT GOOD



neu  
new

BEST  
SELLER

- Bis zu 82 % mehr Materialabtrag als unsere übliche HP-3 Universalverzahnung.
- Hohe Standzeit bei High-Performance.
- Nahezu vibrationsfreies und kontrolliertes arbeiten möglich, selbst bei extremen Schrupparbeiten.
- Erhältlich in der neuesten GREEN-TEC Beschichtungs-Technologie, für nochmalige signifikante Standzeit-erhöhung.
- Für alle Stahlsorten wie:
  - Gusseisen
  - Stahl <60 HRC
  - Edelstahl (INOX)
  - Nickelbasis und Titanlegierungen
  - Auch für Kupfer, Messing, Bronze.

- Up to 82 % more material removal than our usual HP-3 universal cutting style.
- Long tool life comes with high performance.
- Almost vibration-free and controlled work even under tough roughing conditions possible.
- Available in the latest GREEN-TEC coating technology for another significant increase in tool life.
- For all types of steel such as:
  - Cast iron
  - Steel <60 HRC
  - Stainless steel (INOX)
  - Nickel basis and titanium alloy
  - Also for copper, brass, bronze.

### Lagerprogramm + Katalogseiten • Stockrange + catalogue pages

ZYA	ZYB	WRC	KUD	TRE	RBF	SPG	-	KEL	SKM
A	B	C	D	E	F	G	H	L	M
Art. 11 6090 Art. 11 4090	Art. 11 6091 Art. 11 4091	Art. 11 6092 Art. 11 4092	Art. 11 6093 Art. 11 4093	Art. 11 6094 Art. 11 4094	Art. 11 6095 Art. 11 4095	Art. 11 6096 Art. 11 4096	Art. 11 6097 Art. 11 4097	Art. 11 6098 Art. 11 4098	Art. 11 6099 Art. 11 4099
747	747	748	748	749	749	750	750	751	751
Zylinder Cylinder	Zylinder + Stirnverzahnung Cylinder + end cut	Walzenrund- form Ball nosed cylinder	Kugel Ball	Tropfen Oval	Rundbogen Ball nosed tree	Spitzbogen Tree	Flamme Flame	Rundkegel Ball nosed cone	Spitzkegel Cone



GREEN-TEC-beschichtet  
GREEN-TEC-coated



Erhältlich in der neuesten GREEN-TEC-Beschichtungs-Technologie für nochmalige signifikante Standzeiterhöhung.

Available in the latest GREEN-TEC coating technology for another significant increase in tool life.

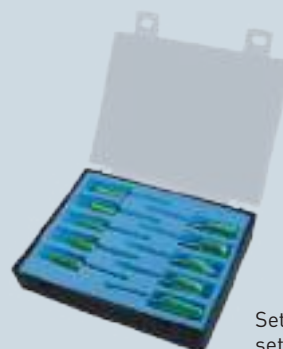

Sets + Displays s. Seite 878  
sets + displays see page 878

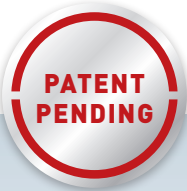

# HP-3 PRO/Performance 82

Die revolutionäre neue Universal-PRO Verzahnung



The revolutionary new Universal-PRO cutting style



Bis zu 82 % mehr Materialabtrag als unsere übliche HP-3 Universalverzahnung.  
\* Ist Ihnen der aggressive Materialabtrag/Schruppen der neuen Universal-PRO Verzahnung zu stark, kann ergänzend auf unsere bewährte HP-3 Universalverzahnung zurückgegriffen werden.



Up to 82% more material removal than our usual HP-3 Universal cutting style.  
\* If the aggressive material removal / roughing of the new Universal-PRO cut appears too strong for you, please use our proven HP-3 universal cut.



Hohe Standzeit bei High-Performance.



Long tool life comes with high performance.



Nahezu vibrationsfreies und kontrolliertes arbeiten möglich, selbst bei extremen Schrupperarbeiten.



Almost vibration-free and controlled work even under tough roughing conditions possible.



Erhältlich in der neuesten GREEN-TEC Beschichtungs-Technologie, für nochmalige signifikante Standzeiterhöhung.



Available in the latest GREEN-TEC coating technology to further increase tool life



## ANWENDUNG · APPLICATION

Stahl Steel	Gehärteter Stahl Hardened steel	Edelstahl Stainless	Gusseisen Cast iron	Titan Titanium	Nickel Nickel	Kupfer, Kupferlegierungen Copper, copper alloys	Alu Alu

Unsere neue HP-3 PRO / Performance 82 ist eine Universalverzahnung für nahezu alle Materialien. Bitte beachten Sie, dass mit unseren Spezialverzahnungen durchaus noch höherer Materialabtrag/Standzeiten möglich sind, wie zum Beispiel:

Our new HP-3 PRO / Performance 82 is a universal cut for almost all materials. Please note that with our special cuts an even higher material removal / tool life is possible. See for example:



### Spezialverzahnungen / special cuts

**HP-9** ☎ 808-814



Speziell für Edelstahl. Extrem hohe Zerspanleistung  
Especially for stainless steel. Extremely high machining output.

**HP-8** ☎ 800-806



Speziell für Stahl und Stahlguss. Extrem hohe Zerspanleistung  
Especially for steel and cast steel. Extremely high machining output

**HP-7** ☎ 784-791



Speziell für NE-Metalle wie Alu, Kupfer, Messing sowie alle Kunststoffe  
Especially for non-ferrous materials such as Aluminum, copper, brass. Also for all kinds of plastics.





Werkstoffgruppen			Bearbeitung	Schnittgeschwindigkeit (m/min)
Stahl, Stahlguss	Stähle bis 1200 N/mm <sup>2</sup> (< 38 HRC)	Baustähle, Kohlenstoffstähle, Werkzeugstähle, unlegierte Stähle, Einsatzstähle, Stahlguss, Vergütungsstähle	Grobzerspanung	450-600
	Gehärtete, vergütete Stähle über 1200 N/mm <sup>2</sup> (> 38 HRC)	Werkzeugstähle, Vergütungsstähle, legierte Stähle, Stahlguss		250-350
Edelstahl (INOX)	Rost- und säurebeständige Stähle	Austenitische und ferritische Edelstähle	Grobzerspanung	250-350
NE-Metalle	Weiche NE-Metalle	Messing, Kupfer, Zink	Grobzerspanung	250-350
	Harte NE-Metalle	Bronze, Titan/Titanlegierungen, harte Aluminiumlegierungen (hoher Si-Anteil)		300-450
Gusseisen	Graues Gusseisen, weißes Gusseisen	Gusseisen mit Lamellengraphit EN-GJL (GG), mit Kugelgraphit/Späroguss EN-GJS (GGG), weißer Temperguss EN-GJMW (GTW), schwarzer Temperguss EN-GJMB (GTS)	Grobzerspanung	450-600

Material groups			Application	Cutting speed m/min
Steel, cast steel	Steels up to 1200 N/mm <sup>2</sup> (< 38 HRC)	Construction steels, carbon steels, tool steels, non-alloyed steels, case-hardened steels, cast steels, alloyed steels	Coarse stock removal	450-600
	Hardened, heat-treated steels exceeding 1200 N/mm <sup>2</sup> (> 38 HRC)	Tool steels, tempering steels, alloyed steel, cast steels		250-350
Stainless steel (INOX)	Rust and acid-resistant steels	Austenitic and ferritic stainless steels	Coarse stock removal	250-350
Non-ferrous metals	Soft-non-ferrous metals	Brass, copper, zinc	Coarse stock removal	250-350
	Hard-non-ferrous metals	Bronze, titanium/titanium alloys, hard aluminum alloys (high Si content)		300-450
Cast iron	Grey cast iron, white cast iron	Cast iron with flake graphite EN-GJL, with nodular graphite cast iron EN-GJS, white annealed cast iron EN-GJMW, black cast iron EN-GJMB	Coarse stock removal	450-600



Schnittgeschwindigkeit • Cutting speed (m/min)							
	250	300	350	400	450	500	600
∅ (mm)	Drehzahlen (min <sup>-1</sup> ) • Rotational speed (rpm)						
6	13.000	16.000	19.000	21.000	24.000	27.000	32.000
8	10.000	12.000	14.000	16.000	18.000	20.000	24.000
10	8.000	10.000	11.000	13.000	14.000	16.000	19.000
12	7.000	8.000	9.000	11.000	12.000	13.000	16.000
16	5.000	6.000	7.000	8.000	9.000	10.000	12.000



11 6090



neu  
new



## A FORM / SHAPE ZYA

Zylinder ohne Stirnverzahnung

Cylinder without end cut

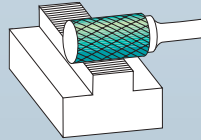

11 4090

neu  
new



Schnittdaten Cutting data	Film Movie
746	

Bestseller – preisreduziert · Bestseller – price reduced

Art.	d1	l2	d2	l1	gelötet brazed	VHM solid	€
11 6090 010	• 6	18	6	50		✓	12,50
11 6090 020	• 8	20	6	65	✓		15,80
11 6090 030	• 10	20	6	65	✓		18,20
11 6090 040	• 12DIN	25	6	70	✓		26,30
11 6090 050	• 16	25	6	70	✓		32,15

Bestseller – preisreduziert · Bestseller – price reduced

Art.	d1	l2	d2	l1	gelötet brazed	VHM solid	€
11 4090 010	• 6	18	6	50		✓	10,20
11 4090 020	• 8	20	6	65	✓		13,35
11 4090 030	• 10	20	6	65	✓		14,35
11 4090 040	• 12DIN	25	6	70	✓		22,40
11 4090 050	• 16	25	6	70	✓		28,20

11 6091



neu  
new

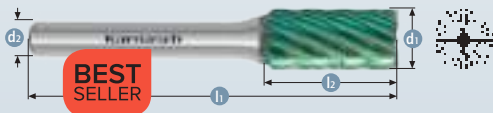

## B FORM / SHAPE ZYB

Zylinder mit Stirnverzahnung

Cylindrical with end cut

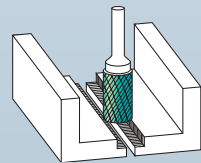

11 4091

neu  
new

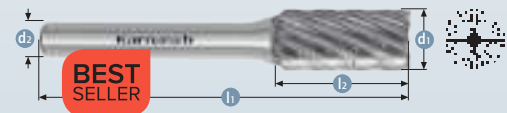

Schnittdaten Cutting data	Film Movie
746	

Bestseller – preisreduziert · Bestseller – price reduced

Art.	d1	l2	d2	l1	gelötet brazed	VHM solid	€
11 6091 010	• 6	18	6	50		✓	13,50
11 6091 020	• 8	20	6	65	✓		17,10
11 6091 030	• 10	20	6	65	✓		19,65
11 6091 040	• 12DIN	25	6	70	✓		28,55
11 6091 050	• 16	25	6	70	✓		35,00

Bestseller – preisreduziert · Bestseller – price reduced

Art.	d1	l2	d2	l1	gelötet brazed	VHM solid	€
11 4091 010	• 6	18	6	50		✓	11,25
11 4091 020	• 8	20	6	65	✓		14,70
11 4091 030	• 10	20	6	65	✓		15,80
11 4091 040	• 12DIN	25	6	70	✓		24,60
11 4091 050	• 16	25	6	70	✓		31,05

- 1
- 2
- 3
- 4
- 5
- 6
- 7
- 8
- 9
- 10



11 6092



neu new

GREENTEC  
BESCHICHTET  
COATED

C FORM / SHAPE WRC

Walzenrundform

Ball nosed cylinder

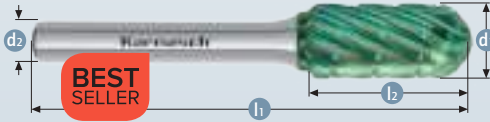
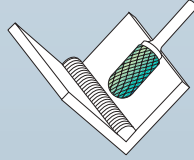

neu new



11 4092

Schnittdaten  
Cutting data

Film  
Movie



Bestseller – preisreduziert · Bestseller – price reduced

Art.	d1	l2	d2	l1	gelötet brazed	VHM solid	€
11 6092 010	• 6	18	6	50		✓	14,15
11 6092 020	• 8	20	6	65	✓		16,95
11 6092 030	• 10	20	6	65	✓		19,80
11 6092 040	• 12DIN	25	6	70	✓		29,05
11 6092 050	• 16	25	6	70	✓		35,50

Bestseller – preisreduziert · Bestseller – price reduced

Art.	d1	l2	d2	l1	gelötet brazed	VHM solid	€
11 4092 010	• 6	18	6	50		✓	11,90
11 4092 020	• 8	20	6	65	✓		14,55
11 4092 030	• 10	20	6	65	✓		16,00
11 4092 040	• 12DIN	25	6	70	✓		25,10
11 4092 050	• 16	25	6	70	✓		31,60

11 6093



neu new

GREENTEC  
BESCHICHTET  
COATED

D FORM / SHAPE KUD

Kugel

Ball

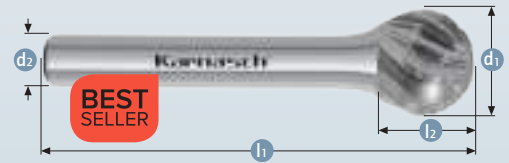
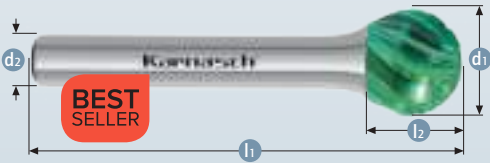
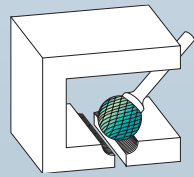

neu new



11 4093

Schnittdaten  
Cutting data

Film  
Movie



Bestseller – preisreduziert · Bestseller – price reduced

Art.	d1	l2	d2	l1	gelötet brazed	VHM solid	€
11 6093 010	• 6	4,8	6	50		✓	13,20
11 6093 020	• 8	7,0	6	52	✓		14,15
11 6093 030	• 10	9,0	6	54	✓		16,95
11 6093 040	• 12DIN	11,0	6	56	✓		21,65
11 6093 050	• 16	14,0	6	59	✓		25,85

Bestseller – preisreduziert · Bestseller – price reduced

Art.	d1	l2	d2	l1	gelötet brazed	VHM solid	€
11 4093 010	• 6	4,8	6	50		✓	10,95
11 4093 020	• 8	7,0	6	52	✓		11,75
11 4093 030	• 10	9,0	6	54	✓		13,10
11 4093 040	• 12DIN	11,0	6	56	✓		17,70
11 4093 050	• 16	14,0	6	59	✓		21,90

11 6094



neu  
new

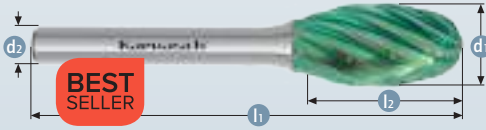

## E FORM / SHAPE TRE

Tropfen

Oval

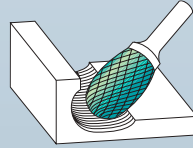

11 4094

neu  
new

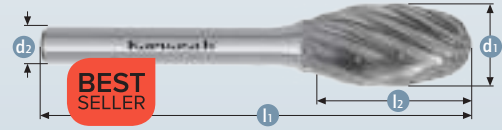

Schnittdaten Cutting data	Film Movie
746	

Bestseller – preisreduziert · Bestseller – price reduced

Art.	d1	l2	d2	l1	gelötet brazed	VHM solid	€
11 6094 010	• 6	10	6	50		✓	15,65
11 6094 020	• 8	15	6	60	✓		17,00
11 6094 030	• 10	15	6	60	✓		19,80
11 6094 040	• 12DIN	20	6	65	✓		27,35
11 6094 050	• 16	25	6	70	✓		36,40

Bestseller – preisreduziert · Bestseller – price reduced

Art.	d1	l2	d2	l1	gelötet brazed	VHM solid	€
11 4094 010	• 6	10	6	50		✓	13,35
11 4094 020	• 8	15	6	60	✓		14,60
11 4094 030	• 10	15	6	60	✓		16,00
11 4094 040	• 12DIN	20	6	65	✓		23,40
11 4094 050	• 16	25	6	70	✓		32,50

11 6095



neu  
new

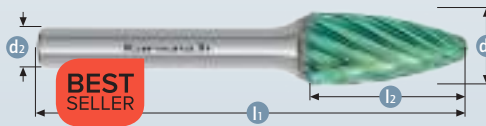

## F FORM / SHAPE RBF

Rundbogen

Ball nosed tree

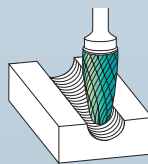

11 4095

neu  
new



Schnittdaten Cutting data	Film Movie
746	

Bestseller – preisreduziert · Bestseller – price reduced

Art.	d1	l2	d2	l1	gelötet brazed	VHM solid	€
11 6095 010	• 6	18	6	50		✓	14,70
11 6095 020	• 8	20	6	65	✓		17,00
11 6095 030	• 10	20	6	65	✓		19,45
11 6095 040	• 12DIN	25	6	70	✓		27,05
11 6095 050	• 16	25	6	70	✓		35,85

Bestseller – preisreduziert · Bestseller – price reduced

Art.	d1	l2	d2	l1	gelötet brazed	VHM solid	€
11 4095 010	• 6	18	6	50		✓	12,40
11 4095 020	• 8	20	6	65	✓		14,60
11 4095 030	• 10	20	6	65	✓		15,65
11 4095 040	• 12DIN	25	6	70	✓		23,10
11 4095 050	• 16	25	6	70	✓		31,90

- 1
- 2
- 3
- 4
- 5
- 6
- 7
- 8
- 9
- 10

- 1
- 2
- 3
- 4
- 5
- 6
- 7
- 8
- 9
- 10

11 6096



neu  
new



G FORM / SHAPE SPG



Spitzbogen

Tree

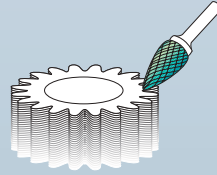

neu  
new



11 4096



Schnittdaten  
Cutting data

Film  
Movie



Bestseller – preisreduziert · Bestseller – price reduced

Art.	d1	l2	d2	l1	gelötet brazed	VHM solid	€
11 6096 010	• 6	18	6	50		✓	14,70
11 6096 020	• 8	20	6	65	✓		17,50
11 6096 030	• 10	20	6	65	✓		20,50
11 6096 040	• 12DIN	25	6	70	✓		26,60
11 6096 050	• 16	25	6	70	✓		35,45

Bestseller – preisreduziert · Bestseller – price reduced

Art.	d1	l2	d2	l1	gelötet brazed	VHM solid	€
11 4096 010	• 6	18	6	50		✓	12,40
11 4096 020	• 8	20	6	65	✓		15,05
11 4096 030	• 10	20	6	65	✓		16,70
11 4096 040	• 12DIN	25	6	70	✓		22,65
11 4096 050	• 16	25	6	70	✓		31,50

11 6097



neu  
new



H FORM / SHAPE

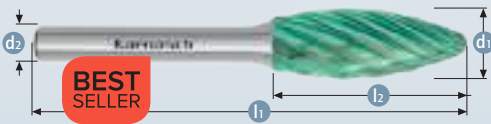

Flamme

Flame

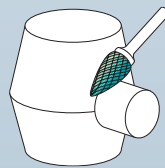

neu  
new



11 4097

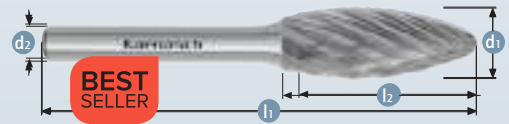

Schnittdaten  
Cutting data

Film  
Movie



Bestseller – preisreduziert · Bestseller – price reduced

Art.	d1	l2	d2	l1	gelötet brazed	VHM solid	€
11 6097 010	• 6	14	6	50		✓	14,70
11 6097 020	• 8	20	6	65	✓		18,85
11 6097 030	• 10	20	6	65	✓		32,40
11 6097 040	• 12DIN	30	6	75	✓		37,40
11 6097 050	• 16	35	6	80	✓		50,15

Bestseller – preisreduziert · Bestseller – price reduced

Art.	d1	l2	d2	l1	gelötet brazed	VHM solid	€
11 4097 010	• 6	14	6	50		✓	12,40
11 4097 020	• 8	20	6	65	✓		16,40
11 4097 030	• 10	20	6	65	✓		28,45
11 4097 040	• 12DIN	30	6	75	✓		33,45
11 4097 050	• 16	35	6	80	✓		46,20

11 6098



neu  
new

GREENTEC  
BESCHICHTET  
COATED

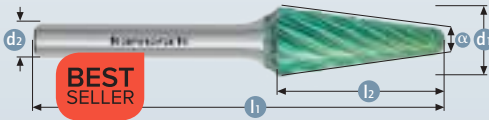

BEST  
SELLER

L FORM / SHAPE **KEL**

Rundkegel

Ball nosed cone



neu  
new



11 4098

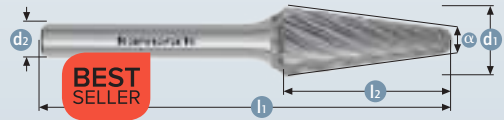

BEST  
SELLER

Schnittdaten  
Cutting data

**i**

746

Film  
Movie

**▶**

Bestseller – preisreduziert · Bestseller – price reduced

Art.	d1	l2	d2	l1	gelötet brazed	VHM solid	α°	€
11 6098 010	• 6	18	6	50	✓	✓	14°	15,00
11 6098 020	• 8	25	6	70	✓		14°	19,05
11 6098 030	• 10	20	6	65	✓		14°	19,90
11 6098 040	• 12DIN	30	6	75	✓		14°	28,35
11 6098 050	• 16	33	6	78	✓		14°	47,15

Bestseller – preisreduziert · Bestseller – price reduced

Art.	d1	l2	d2	l1	gelötet brazed	VHM solid	α°	€
11 4098 010	• 6	18	6	50	✓	✓	14°	12,70
11 4098 020	• 8	25	6	70	✓		14°	16,65
11 4098 030	• 10	20	6	65	✓		14°	16,00
11 4098 040	• 12DIN	30	6	75	✓		14°	24,40
11 4098 050	• 16	33	6	78	✓		14°	43,20

11 6099



neu  
new

GREENTEC  
BESCHICHTET  
COATED

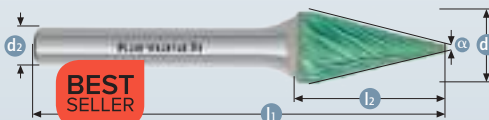

BEST  
SELLER

M FORM / SHAPE **SKM**

Spitzkegel

Cone

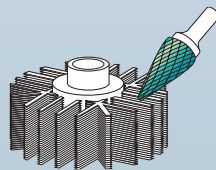

neu  
new



11 4099

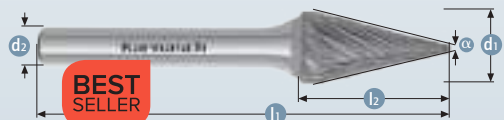

BEST  
SELLER

Schnittdaten  
Cutting data

**i**

746

Film  
Movie

**▶**

Bestseller – preisreduziert · Bestseller – price reduced

Art.	d1	l2	d2	l1	gelötet brazed	VHM solid	α°	€
11 6099 010	• 6	18	6	50	✓	✓	14°	15,00
11 6099 020	• 8	20	6	65	✓		13°	20,95
11 6099 030	• 10	20	6	65	✓		28°	23,95
11 6099 040	• 12DIN	26	6	71	✓		28°	29,00
11 6099 050	• 16	25	6	70	✓		33°	37,40

Bestseller – preisreduziert · Bestseller – price reduced

Art.	d1	l2	d2	l1	gelötet brazed	VHM solid	α°	€
11 4099 010	• 6	18	6	50	✓	✓	14°	12,70
11 4099 020	• 8	20	6	65	✓		13°	18,55
11 4099 030	• 10	20	6	65	✓		28°	20,05
11 4099 040	• 12DIN	26	6	71	✓		28°	25,05
11 4099 050	• 16	25	6	70	✓		33°	33,45

- 1
- 2
- 3
- 4
- 5
- 6
- 7
- 8
- 9
- 10

# HP-3

Die am meisten verwendete Universalverzählung  
The most widely used universal cutting style

## ANWENDUNG · APPLICATION















 Stahl Steel	 Gehärteter Stahl Hardened steel	 Edelstahl Stainless	 Gusseisen Cast iron	 Titan Titanium	 Cermet Cermet	 Nickel Nickel	 Kupfer, Kupferlegierungen Copper, copper alloys	 Alu Alu	 Kunststoffe GFK/CFK Plastics GRP/CRP
---	---	---	---	--	---	--	---	---	--

✓ OPTIMAL  
OPTIMAL  
✓ GUT  
GOOD

- Hohe Zerspanleistung durch Kreuzverzählung:
  - Ruhiger Lauf
  - Kurze Späne
- Für alle Stahlsorten wie:
  - Gusseisen
  - Stahl < 60 HRC
  - Edelstahl (INOX)
  - Nickelbasis- und Titanlegierungen
- Auch Kupfer, Messing, Bronze

- High cutting action through cross cutting style
  - Smooth operation
  - Short chips
- For use on all ferrous metals such as:
  - Cast iron
  - Steel < 60 HRC
  - Stainless steel (INOX)
  - Nickel basis and titanium alloy
- Also copper, brass, bronze

### Lagerprogramm + Katalogseiten • Stockrange + catalogue pages

ZYA	ZYB	ZYA	WRC	KUD	TRE	RBF	SPG	-	KEL	SKM	WKN	KSJ	KSK
A	B		C	D	E	F	G	H	L	M	N	J	K
Art. 11 5001 Art. 11 3001	Art. 11 5011 Art. 11 3011	Art. 11 6010 Art. 11 4010	Art. 11 5021 Art. 11 3021	Art. 11 5031 Art. 11 3031	Art. 11 5041 Art. 11 3041	Art. 11 5051 Art. 11 3051	Art. 11 5061 Art. 11 3061	Art. 11 5071 Art. 11 3071	Art. 11 5081 Art. 11 3081	Art. 11 5091 Art. 11 3091	Art. 11 5096 Art. 11 3096	Art. 11 5101 Art. 11 3101	Art. 11 5111 Art. 11 3111
													
754	755	757	758	759	760	761	762	763	763	764	764	765	765
Zylinder Cylinder	Zylinder + Stirnverzählung Cylinder + end cut	Zylinder-Radius Cylinder-Radius	Walzenrundform Ball nosed cylinder	Kugel Ball	Tropfen Oval	Rundbogen Ball nosed tree	Spitzbogen Tree	Flamme Flame	Rundkegel Ball nosed cone	Spitzkegel Cone	Winkel Inverted cone	Kegel 60° Countersink 60°	Kegel 90° Countersink 90°



BLUE-TEC-beschichtet  
BLUE-TEC-coated



Die für Frässtifte optimierte und patentierte BLUE-TEC-Beschichtung ergibt einzigartige Standzeiten und Performance in allen Stahlsorten.

Patented BLUE-TEC coating, specifically designed for burrs, gives outstanding tool life and excellent performance on all metals.



Sets + Displays s. Seite 879  
sets + displays see page 879

Werkstoffgruppen			Bearbeitung	Schnittgeschwindigkeit (m/min)
Stahl, Stahlguss	Ungehärtete, nicht vergütete Stähle bis 1200 N/mm <sup>2</sup> (< 38 HRC)	Baustähle, Kohlenstoffstähle, Werkzeugstähle, unlegierte Stähle, Einsatzstähle, Stahlguss	Grobes Zerspanen mit hohem Materialabtrag	450-600
	Gehärtete, vergütete Stähle über 1200 N/mm <sup>2</sup> (> 38 HRC)	Werkzeugstähle, Vergütungsstähle, legierte Stähle, Stahlguss		250-350
Edelstahl (INOX)	Rost- und säurebeständige Stähle	Austenitische und ferritische Edelstähle	Grobes Zerspanen mit hohem Materialabtrag	250-350
NE-Metalle	Harte NE-Metalle	Bronze, Titan/Titanlegierungen, harte Alulegierungen (hoher Si-Anteil)	Grobes Zerspanen mit hohem Materialabtrag	250-350
	Hochwarmfeste Werkstoffe	Nickelbasis- und Kobaltbasislegierungen (Triebwerk- und Turbinenbau)		300-450
Gusseisen	Graues Gusseisen, weißes Gusseisen	Gusseisen mit Lamellengraphit EN-GJL (GG), mit Kugelgraphit/Späroguss EN-GJS (GGG), weißer Temperguss EN-GJMW (GTW), schwarzer Temperguss EN-GJMB (GTS)	Grobes Zerspanen mit hohem Materialabtrag	450-600

Material groups			Application	Cutting speed m/min
Steel, cast steel	Non-hardened, non-heat treated steels up to 1200 N/mm <sup>2</sup> (< 38 HRC)	Construction steels, carbon steels, tool steels, non-alloyed steels, case-hardened steels, cast steels	Coarse machining with high stock removal	450-600
	Hardened, heat-treated steels exceeding 1200 N/mm <sup>2</sup> (> 38 HRC)	Tool steels, tempering steels, alloyed steel, cast steels		250-350
Stainless steel (INOX)	Rust and acid-resistant steels	Austenitic and ferritic stainless steels	Coarse machining with high stock removal	250-350
Non-ferrous metals	Hard-non-ferrous metals	Bronze, titanium/titanium alloys, hard alu-alloys (high Si content)	Coarse machining with high stock removal	250-350
	High-temperature resistant materials	Nickel based alloys, cobalt based alloys (aircraft engine and turbine construction)		300-450
Cast iron	Grey cast iron, white cast iron	Cast iron with flake graphite EN-GJL, with nodular graphite cast iron EN-GJS, white annealed cast iron EN-GJMW, black cast iron EN-GJMB	Coarse machining with high stock removal	450-600



Schnittgeschwindigkeit • Cutting speed (m/min)							
	250	300	350	400	450	500	600
∅ (mm)	Drehzahlen (min <sup>-1</sup> ) • Rotational speed (rpm)						
2	40.000	48.000	56.000	64.000	72.000	80.000	95.000
3	27.000	32.000	37.000	42.000	48.000	53.000	64.000
4	20.000	24.000	28.000	32.000	36.000	40.000	48.000
6	13.000	16.000	19.000	21.000	24.000	27.000	32.000
8	10.000	12.000	14.000	16.000	18.000	20.000	24.000
10	8.000	10.000	11.000	13.000	14.000	16.000	19.000
12	7.000	8.000	9.000	11.000	12.000	13.000	16.000
16	5.000	6.000	7.000	8.000	9.000	10.000	12.000
20	4.000	5.000	6.000	6.000	7.000	8.000	10.000
25	3.000	4.000	4.000	5.000	6.000	6.000	8.000



11 5001



A FORM / SHAPE

ZYA

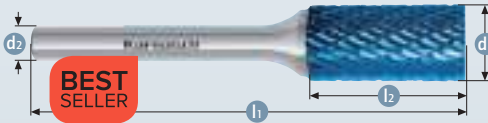

Zylinder ohne Stirnverzahnung

Cylinder without end cut

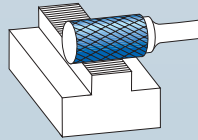

11 3001



Schnittdaten  
Cutting data

Film  
Movie



Bestseller – preisreduziert · Bestseller – price reduced

Art.	d1	l2	d2	l1	gelötet brazed	VHM solid	€
11 5001 015	1,5	6	3	38		✓	7,60
11 5001 025	2	11	3	38		✓	7,60
11 5001 027	2,5	11	3	38		✓	7,60
11 5001 030	3	14	3	38		✓	7,60
11 5001 035	3	14	3	50		✓	8,95
11 5001 040	3	14	3	65		✓	9,90
11 5001 045	3	14	3	75		✓	10,90
11 5001 050	3	14	3	100		✓	13,60
11 5001 052	3	12,7	6	50		✓	10,10
11 5001 055	4	14	6	50		✓	10,10
11 5001 057	5	12,7	3	38		✓	15,70
11 5001 058	5	16	6	50		✓	10,10
11 5001 059	6	5	3	37	✓		9,65
11 5001 060	6	13	3	45	✓		12,20
11 5001 065	6	18	6	50		✓	10,10
11 5001 067	6	25	6	50		✓	13,70
11 5001 070	6	18	6	100	✓		17,85
11 5001 075	6	18	6	150	✓		25,40
11 5001 080	8	20	6	65	✓		12,60
11 5001 085	8	20	6	170	✓		18,30
11 5001 087	10	13	6	58	✓		15,50
11 5001 090	10	20	6	65	✓		14,50
11 5001 095	10	20	6	172	✓		21,95
11 5001 100	10	25	6	70	✓		16,70
11 5001 103	12	20	6	64	✓		23,75
11 5001 105	12	25	6	70	✓		22,25
11 5001 107	12DIN	25	6	70	✓		20,50
11 5001 110	12	25	6	175	✓		32,25
11 5001 115	12	25	8	70	✓		24,20
11 5001 120	16	25	6	70	✓		26,95
11 5001 125	16	25	8	70	✓		28,95
11 5001 130	20	25	6	70	✓		40,90
11 5001 140	25	25	6	70	✓		52,80
11 5001 145	25	25	8	70	✓		54,75

Bestseller – preisreduziert · Bestseller – price reduced

Valuetool – hervorragendes Preis-Leistungs-Verhältnis  
Valuetool – excellent price-performance ratio

Art.	d1	l2	d2	l1	gelötet brazed	VHM solid	€
11 3001 015	1,5	6	3	38		✓	5,80
11 3001 025	2	11	3	38		✓	5,80
11 3001 027	2,5	11	3	38		✓	3,60
11 3001 030	3	14	3	38		✓	5,80
11 3001 031	3	14	3	38		✓	3,95
11 3001 035	3	14	3	50		✓	7,20
11 3001 040	3	14	3	65		✓	8,10
11 3001 045	3	14	3	75		✓	9,15
11 3001 050	3	14	3	100		✓	11,80
11 3001 052	3	12,7	6	50		✓	8,30
11 3001 055	4	14	6	50		✓	8,30
11 3001 057	5	12,7	3	38		✓	13,95
11 3001 058	5	16	6	50		✓	8,30
11 3001 059	6	5	3	37	✓		7,85
11 3001 060	6	13	3	45	✓		10,45
11 3001 065	6	18	6	50		✓	8,30
11 3001 066	6	18	6	50		✓	6,20
11 3001 067	6	25	6	50		✓	11,95
11 3001 070	6	18	6	100	✓		16,05
11 3001 075	6	18	6	150	✓		22,60
11 3001 080	8	20	6	65	✓		10,80
11 3001 081	8	20	6	65	✓		8,10
11 3001 085	8	20	6	170	✓		15,50
11 3001 087	10	13	6	58	✓		12,65
11 3001 090	10	20	6	65	✓		11,60
11 3001 091	10	20	6	65	✓		8,70
11 3001 095	10	20	6	172	✓		16,20
11 3001 100	10	25	6	70	✓		13,80
11 3001 103	12	20	6	64	✓		19,55
11 3001 105	12	25	6	70	✓		18,05
11 3001 107	12DIN	25	6	70	✓		16,30
11 3001 108	12DIN	25	6	70	✓		12,40
11 3001 110	12	25	6	175	✓		25,25
11 3001 115	12	25	8	70	✓		19,95
11 3001 120	16	25	6	70	✓		22,75
11 3001 121	16	25	6	70	✓		17,10
11 3001 125	16	25	8	70	✓		24,75
11 3001 130	20	25	6	70	✓		33,85
11 3001 140	25	25	6	70	✓		47,35
11 3001 145	25	25	8	70	✓		30,60

Der revolutionäre Zylinder-Radius Frässtift siehe Seite 756/757  
The revolutionary cylinder-radius burr see page 756/757



- 1
- 2
- 3
- 4
- 5
- 6
- 7
- 8
- 9
- 10



11 5011



## B FORM / SHAPE ZYB

Zylinder mit Stirnverzahnung

Cylinder with end cut

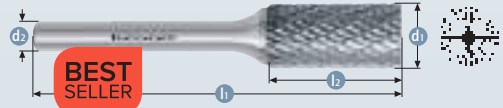
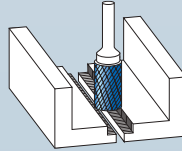

Schnittdaten  
Cutting data

753

Film  
Movie

**Bestseller – preisreduziert · Bestseller – price reduced**

Art.	d1	l2	d2	l1	gelötet brazed	VHM solid	€
11 5011 005	• 1,5	6	3	38		✓	7,55
11 5011 010	• 2	11	3	38		✓	8,20
11 5011 012	• 2,5	11	3	38		✓	7,55
11 5011 015	• 3	14	3	38		✓	7,45
11 5011 020	• 3	14	3	50		✓	9,60
11 5011 025	• 3	14	3	65		✓	10,70
11 5011 030	• 3	14	3	75		✓	11,80
11 5011 035	• 3	14	3	100		✓	14,80
11 5011 037	• 3	12,7	6	50		✓	10,70
11 5011 040	• 4	14	6	50		✓	10,70
11 5011 042	• 5	16	6	50		✓	10,70
11 5011 043	• 6	5	3	37	✓		11,30
11 5011 045	• 6	13	3	45	✓		13,25
11 5011 050	• 6	18	6	50		✓	10,70
11 5011 055	• 6	18	6	75		✓	13,45
11 5011 060	• 6	18	6	100	✓		19,45
11 5011 065	• 6	18	6	150	✓		27,65
11 5011 070	• 6	25	6	50		✓	14,90
11 5011 075	• 8	20	6	65	✓		13,60
11 5011 080	• 8	20	6	170	✓		19,85
11 5011 082	• 10	13	6	58	✓		16,80
11 5011 085	• 10	20	6	65	✓		15,60
11 5011 090	• 10	20	6	172	✓		24,05
11 5011 095	• 10	25	6	70	✓		17,95
11 5011 097	• 11	25	6	70	✓		13,25
11 5011 099	• 12	20	6	64	✓		25,75
11 5011 100	• 12	25	6	70	✓		24,05
11 5011 103	• 12DIN	25	6	70	✓		22,10
11 5011 105	• 12	25	6	175	✓		35,65
11 5011 110	• 12	25	8	70	✓		26,15
11 5011 115	• 16	25	6	70	✓		29,20
11 5011 120	• 16	25	8	70	✓		31,15
11 5011 125	• 20	25	6	70	✓		42,70
11 5011 130	• 20	25	8	70	✓		44,90
11 5011 135	• 25	25	6	70	✓		57,55
11 5011 140	• 25	25	8	70	✓		59,50

**Bestseller – preisreduziert · Bestseller – price reduced**

Valuetool – hervorragendes Preis-Leistungs-Verhältnis  
Valuetool – excellent price-performance ratio

Art.	d1	l2	d2	l1	gelötet brazed	VHM solid	€
11 3011 005	• 1,5	6	3	38		✓	5,80
11 3011 010	• 2	11	3	38		✓	6,45
11 3011 012	• 2,5	11	3	38		✓	5,80
11 3011 015	• 3	14	3	38		✓	5,70
11 3011 016	• 3	14	3	38		✓	4,35 <b>NEW</b>
11 3011 020	• 3	14	3	50		✓	7,85
11 3011 025	• 3	14	3	65		✓	8,90
11 3011 030	• 3	14	3	75		✓	10,00
11 3011 035	• 3	14	3	100		✓	13,00
11 3011 037	• 3	12,7	6	50		✓	8,95
11 3011 040	• 4	14	6	50		✓	8,95
11 3011 042	• 5	16	6	50		✓	8,95
11 3011 043	• 6	5	3	37	✓		9,50
11 3011 045	• 6	13	3	45	✓		11,50
11 3011 050	• 6	18	6	50		✓	8,95
11 3011 051	• 6	18	6	50		✓	6,80 <b>NEW</b>
11 3011 055	• 6	18	6	75		✓	11,65
11 3011 060	• 6	18	6	100	✓		17,65
11 3011 065	• 6	18	6	150	✓		24,85
11 3011 070	• 6	25	6	50		✓	13,10
11 3011 075	• 8	20	6	65	✓		11,85
11 3011 076	• 8	20	6	65	✓		8,90 <b>NEW</b>
11 3011 080	• 8	20	6	170	✓		17,00
11 3011 082	• 10	13	6	58	✓		8,65
11 3011 085	• 10	20	6	65	✓		12,75
11 3011 086	• 10	20	6	65	✓		9,60 <b>NEW</b>
11 3011 090	• 10	20	6	172	✓		18,25
11 3011 095	• 10	25	6	70	✓		15,10
11 3011 097	• 11	25	6	70	✓		18,50
11 3011 099	• 12	20	6	64	✓		21,55
11 3011 100	• 12	25	6	70	✓		19,85
11 3011 103	• 12DIN	25	6	70	✓		17,90
11 3011 104	• 12DIN	25	6	70	✓		13,65 <b>NEW</b>
11 3011 105	• 12	25	6	175	✓		28,60
11 3011 110	• 12	25	8	70	✓		21,95
11 3011 115	• 16	25	6	70	✓		25,00
11 3011 116	• 16	25	6	70	✓		18,80 <b>NEW</b>
11 3011 120	• 16	25	8	70	✓		26,95
11 3011 125	• 20	25	6	70	✓		37,25
11 3011 130	• 20	25	8	70	✓		39,45
11 3011 135	• 25	25	6	70	✓		52,10
11 3011 140	• 25	25	8	70	✓		54,05

Der revolutionäre Zylinder-Radius Frässtift siehe Seite 756/757  
The revolutionary cylinder-radius burr see page 756/757



1



2



3



4



5



6



7



8



9



10

Index



## Das einzigartige **CYLINDER+RADIUS** Design verwandelt den herkömmlichen Zylinder Frässtift in ein Hightech Werkzeug.

Diese neue Entwicklung erfüllt die höchsten Herstellungsstandards für alle Arten der Anwendung in der Industrie, darunter speziell auch für die Luft- und Raumfahrtindustrie.

Das spezielle Radius-Design an der Spitze des Zylinders vermeidet Zahnbruch und erhöht wesentlich die Standzeit.

### Durch Radiusdesign:

- kein Verkanten / Abrutschen in das Werkstück.
- Beschädigungen von teuren Werkzeugen werden vermieden.

### Durch Kreuzverzahnung:

- exzellente Kontrolle und Führung beim Entgratvorgang.

### Eigenschaften und Vorteile:

Der Radius an der Spitze des Fräasers ergibt:

- verbesserte Nutzenstabilität durch verrundete Kanten.
- Der Radius ermöglicht eine bessere Kontrolle während des Schleifvorgangs.
- Die Rundung verhindert das Verkanten / Abrutschen in das Werkstück.
- Erzeugung eines Radius' auf dem Werkstück
- Rundung reduziert Bruch an der Schnittkante des Fräasers.

## The **CYLINDER+RADIUS** unique design transforms the conventional cylinder burr into a hightech tool.

The new development meets the highest manufacturing standards for all kind of industries, especially the aerospace industry.

The radius design at the top of the cylinder provides an extended tool life avoiding teeth breakage.

This unique design with its **double cut** will improve operator control, reduce the size of chips and prevent damage to expensive parts.

### Features and benefits:

Radius at the top of the cylinder results:

- Offers improved flute strength at the start of the burr.
- The radius provides better control of the burr.
- Prevents digging into work piece at the intersecting point.
- Produces a cylinder radius on the work piece.
- Reduces flute chipping at the intersecting point.

11 6010



HP-3



11 4010

**A** FORM / SHAPE **ZYA**

Zylinder-Radius

Cylinder-Radius

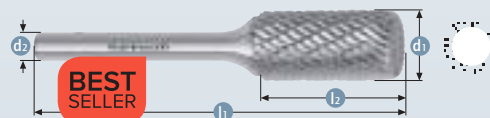
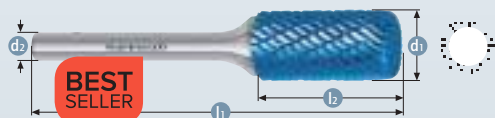

Schnittdaten Cutting data	Film Movie
753	

Bestseller – preisreduziert · Bestseller – price reduced

Art.	d1	l2	d2	l1	gelötet brazed	VHM solid	€
11 6010 005	• 3	14	3	38		✓	8,45
11 6010 010	• 6	18	6	50		✓	11,30
11 6010 015	• 8	19	6	64	✓		14,15
11 6010 020	• 10	19	6	64	✓		16,25
11 6010 025	• 12	25	6	70	✓		24,95
11 6010 030	• 16	25	6	70	✓		30,35

Bestseller – preisreduziert · Bestseller – price reduced

Art.	d1	l2	d2	l1	gelötet brazed	VHM solid	€
11 4010 005	• 3	14	3	38		✓	6,65
11 4010 010	• 6	18	6	50		✓	9,55
11 4010 015	• 8	19	6	64	✓		12,40
11 4010 020	• 10	19	6	64	✓		13,35
11 4010 025	• 12	25	6	70	✓		20,75
11 4010 030	• 16	25	6	70	✓		26,15

## Anwendungsbeispiele / Application examples



1



2



3



4



5



6



7



8



9



10



Index

11 5021



C FORM / SHAPE WRC

Walzenrundform

Ball nosed cylinder

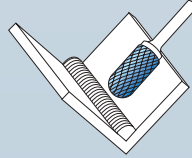

11 3021



Schnittdaten  
Cutting data

Film  
Movie



Bestseller – preisreduziert · Bestseller – price reduced

Bestseller – preisreduziert · Bestseller – price reduced

Valuetool – hervorragendes Preis-Leistungs-Verhältnis  
Valuetool – excellent price-performance ratio

Art.	d1	l2	d2	l1	gelötet brazed	VHM solid	€
11 5021 020	2	11	3	38		✓	7,60
11 5021 022	2,5	11	3	38		✓	7,45
11 5021 025	3	14	3	38		✓	7,60
11 5021 030	3	14	3	50		✓	9,90
11 5021 032	3	14	3	60		✓	10,40
11 5021 035	3	14	3	75		✓	10,90
11 5021 040	3	14	3	100		✓	13,70
11 5021 042	3	12,7	6	50		✓	11,75
11 5021 043	3	30*[15]	6	60		✓	21,70
11 5021 045	4	16	6	50		✓	11,35
11 5021 046	4	30*[15]	6	60		✓	22,25
11 5021 047	5	12,7	3	38		✓	15,70
11 5021 049	5	16	6	50		✓	11,35
11 5021 050	6	12,7	3	44	✓		11,30
11 5021 055	6	18	6	50		✓	11,35
11 5021 056	6	18	6	60		✓	15,20
11 5021 058	6	18	6	80		✓	18,05
11 5021 060	6	18	6	100	✓		20,40
11 5021 065	6	18	6	150	✓		29,00
11 5021 070	6	25	6	50		✓	14,90
11 5021 075	8	20	6	65	✓		13,50
11 5021 080	8	20	6	170	✓		19,70
11 5021 085	10	20	6	65	✓		15,75
11 5021 090	10	20	6	170	✓		23,80
11 5021 095	10	25	6	70	✓		18,00
11 5021 097	11	25	6	70	✓		22,65
11 5021 099	12	10	6	54	✓		26,20
11 5021 100	12	20	6	65	✓		25,80
11 5021 105	12	25	6	70	✓		24,45
11 5021 107	12DIN	25	6	70	✓		22,50
11 5021 110	12	25	6	175	✓		35,35
11 5021 115	12	25	8	70	✓		26,60
11 5021 120	16	25	6	70	✓		29,75
11 5021 125	16	25	8	70	✓		32,60
11 5021 130	20	25	6	70	✓		42,10
11 5021 135	20	25	8	70	✓		44,00

Art.	d1	l2	d2	l1	gelötet brazed	VHM solid	€
11 3021 020	2	11	3	38		✓	5,80
11 3021 022	2,5	11	3	38		✓	5,70
11 3021 025	3	14	3	38		✓	5,80
11 3021 026	3	14	3	38		✓	3,95
11 3021 030	3	14	3	50		✓	8,10
11 3021 032	3	14	3	60		✓	8,60
11 3021 035	3	14	3	75		✓	9,15
11 3021 040	3	14	3	100		✓	11,90
11 3021 042	3	12,7	6	50		✓	9,95
11 3021 043	3	30*[15]	6	60		✓	19,95
11 3021 045	4	16	6	50		✓	9,60
11 3021 046	4	30*[15]	6	60		✓	20,50
11 3021 047	5	12,7	3	38		✓	13,95
11 3021 049	5	16	6	50		✓	9,60
11 3021 050	6	12,7	3	44	✓		9,50
11 3021 054	6	18	6	50		✓	7,20
11 3021 055	6	18	6	50		✓	9,60
11 3021 056	6	18	6	60		✓	13,40
11 3021 058	6	18	6	80		✓	16,30
11 3021 060	6	18	6	100	✓		18,65
11 3021 065	6	18	6	150	✓		26,20
11 3021 070	6	25	6	50		✓	13,10
11 3021 075	8	20	6	65	✓		11,75
11 3021 076	8	20	6	65	✓		8,85
11 3021 080	8	20	6	170	✓		16,90
11 3021 085	10	20	6	65	✓		12,90
11 3021 086	10	20	6	65	✓		9,70
11 3021 090	10	20	6	170	✓		18,00
11 3021 095	10	25	6	70	✓		15,10
11 3021 097	11	25	6	70	✓		18,45
11 3021 100	12	20	6	65	✓		21,60
11 3021 105	12	25	6	70	✓		20,25
11 3021 107	12DIN	25	6	70	✓		18,30
11 3021 108	12DIN	25	6	70	✓		13,90
11 3021 110	12	25	6	175	✓		28,35
11 3021 115	12	25	8	70	✓		22,40
11 3021 120	16	25	6	70	✓		25,55
11 3021 121	16	25	6	70	✓		19,10
11 3021 125	16	25	8	70	✓		28,35
11 3021 130	20	25	6	70	✓		36,60
11 3021 135	20	25	8	70	✓		38,55

- Frässtifte speziell für Schlüsseldienste siehe Seite 838/839  
Burrs specially for locksmiths see page 838/839

\* 11 5021 043



\* 11 3021 043



\* 11 5021 046



\* 11 3021 046



- \* Von 30 mm sind 15 mm verzahnt  
15 mm by 30 mm are not machined



11 5031

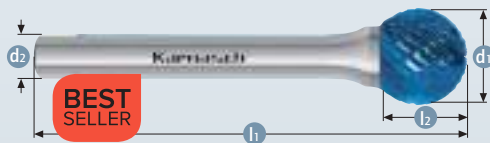

## D FORM / SHAPE KUD

Kugel

Ball

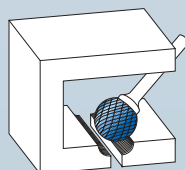

11 3031

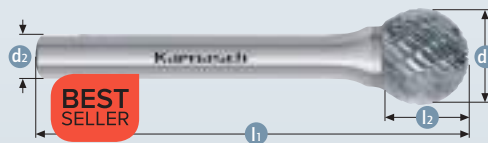

NEW VALUETOOL

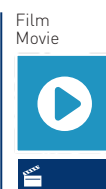
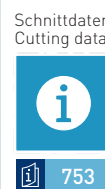

### Bestseller – preisreduziert · Bestseller – price reduced

Art.	d1	l2	d2	l1	gelötet brazed	VHM solid	€
11 5031 020	2	1,8	3	38		✓	7,60
11 5031 022	2,5	2,3	3	38		✓	7,60
11 5031 025	3	2,5	3	38		✓	7,60
11 5031 030	3	2,5	3	50		✓	9,30
11 5031 035	3	2,5	3	75		✓	10,30
11 5031 040	3	2,5	6	50		✓	10,55
11 5031 045	4	3,4	3	38		✓	15,70
11 5031 046	4	3,4	6	50		✓	10,95
11 5031 047	5	4,7	3	38		✓	15,70
11 5031 048	5	5,0	6	50		✓	10,55
11 5031 050	6	5,0	3	38	✓		10,95
11 5031 055	6	4,7	6	50		✓	10,55
11 5031 060	8	6,0	6	52	✓		11,25
11 5031 065	8	6,0	6	180	✓		16,35
11 5031 070	10	8,0	6	54	✓		13,45
11 5031 075	10	8,0	6	185	✓		20,65
11 5031 077	11	9,5	6	55	✓		16,45
11 5031 080	12	11,4	6	56	✓		18,40
11 5031 083	12DIN	11,0	6	56	✓		17,05
11 5031 085	12	11,0	8	56	✓		19,30
11 5031 090	12	11,0	6	162	✓		27,00
11 5031 095	16	14,0	6	60	✓		21,90
11 5031 100	16	14,0	8	60	✓		23,90
11 5031 105	20	16,5	6	62	✓		29,85
11 5031 110	20	16,5	8	62	✓		31,90
11 5031 115	25	22,0	6	68	✓		47,40
11 5031 120	25	22,0	8	68	✓		49,30

### Bestseller – preisreduziert · Bestseller – price reduced

Valuetooll – hervorragendes Preis-Leistungs-Verhältnis  
Valuetooll – excellent price-performance ratio

Art.	d1	l2	d2	l1	gelötet brazed	VHM solid	€
11 3031 020	2	1,8	3	38		✓	5,80
11 3031 022	2,5	2,3	3	38		✓	5,80
11 3031 025	3	2,5	3	38		✓	5,80
11 3031 026	3	2,5	3	38		✓	3,95 NEW
11 3031 030	3	2,5	3	50		✓	7,50
11 3031 035	3	2,5	3	75		✓	8,55
11 3031 040	3	2,5	6	50		✓	8,75
11 3031 045	4	3,4	3	38		✓	13,95
11 3031 046	4	3,4	6	50		✓	9,15
11 3031 047	5	4,7	3	38		✓	13,95
11 3031 048	5	5,0	6	50		✓	8,75
11 3031 050	6	5,0	3	38	✓		9,15
11 3031 055	6	4,7	6	50		✓	8,75
11 3031 056	6	4,7	6	50		✓	6,65 NEW
11 3031 060	8	6,0	6	52	✓		9,45
11 3031 061	8	7,0	6	52	✓		7,10 NEW
11 3031 065	8	6,0	6	180	✓		13,55
11 3031 070	10	8,0	6	54	✓		10,60
11 3031 071	10	9,0	6	54	✓		7,95 NEW
11 3031 075	10	8,0	6	185	✓		14,85
11 3031 077	11	9,5	6	55	✓		12,25
11 3031 080	12	11,4	6	56	✓		14,20
11 3031 083	12DIN	11,0	6	56	✓		12,85
11 3031 084	12DIN	11,0	6	56	✓		9,80 NEW
11 3031 085	12	11,0	8	56	✓		15,10
11 3031 090	12	11,0	6	162	✓		19,95
11 3031 095	16	14,0	6	60	✓		17,65
11 3031 096	16	14,0	6	60	✓		13,30 NEW
11 3031 100	16	14,0	8	60	✓		19,70
11 3031 105	20	16,5	6	62	✓		24,35
11 3031 110	20	16,5	8	62	✓		26,40
11 3031 115	25	22,0	6	68	✓		41,90
11 3031 120	25	22,0	8	68	✓		43,85



11 5041



E FORM / SHAPE

TRE

Tropfen

Oval

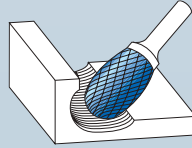

11 3041

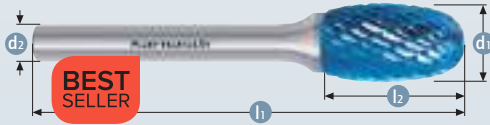

Schnittdaten  
Cutting data

Film  
Movie



Bestseller – preisreduziert · Bestseller – price reduced

Art.	d1	l2	d2	l1	gelötet brazed	VHM solid	€
11 5041 010	3	6	3	38	✓	✓	7,60
11 5041 011	3	6	3	75	✓	✓	11,10
11 5041 012	5	7,1	3	38	✓	✓	15,70
11 5041 015	6	10	3	42	✓	✓	11,30
11 5041 020	6	10	6	50	✓	✓	12,60
11 5041 025	8	15	6	60	✓	✓	14,80
11 5041 030	10	16	6	60	✓	✓	15,75
11 5041 032	10	16	6	170	✓	✓	29,30
11 5041 035	12	22	6	67	✓	✓	23,05
11 5041 037	12DIN	21	6	66	✓	✓	21,25
11 5041 038	12	22	6	175	✓	✓	22,45
11 5041 040	12	22	8	67	✓	✓	25,05
11 5041 045	16	25	6	70	✓	✓	30,35
11 5041 050	16	25	8	70	✓	✓	33,30
11 5041 055	20	25	6	70	✓	✓	40,70
11 5041 060	20	25	8	70	✓	✓	42,65

Bestseller – preisreduziert · Bestseller – price reduced

Valuetool – hervorragendes Preis-Leistungs-Verhältnis  
Valuetool – excellent price-performance ratio

Art.	d1	l2	d2	l1	gelötet brazed	VHM solid	€
11 3041 005	3	6	3	50	✓	✓	7,60
11 3041 009	3	6	3	38	✓	✓	3,95
11 3041 010	3	6	3	38	✓	✓	5,80
11 3041 011	3	6	3	75	✓	✓	9,35
11 3041 012	5	7,1	3	38	✓	✓	13,95
11 3041 015	6	10	3	42	✓	✓	9,50
11 3041 020	6	10	6	50	✓	✓	10,80
11 3041 021	6	10	6	50	✓	✓	8,10
11 3041 025	8	15	6	60	✓	✓	13,05
11 3041 026	8	15	6	60	✓	✓	8,85
11 3041 030	10	16	6	60	✓	✓	12,90
11 3041 031	10	16	6	60	✓	✓	9,70
11 3041 035	12	22	6	67	✓	✓	18,80
11 3041 036	12DIN	21	6	66	✓	✓	12,95
11 3041 037	12DIN	21	6	66	✓	✓	17,05
11 3041 038	12	22	6	175	✓	✓	29,20
11 3041 040	12	22	8	67	✓	✓	20,85
11 3041 045	16	25	6	70	✓	✓	26,15
11 3041 046	16	25	6	70	✓	✓	19,70
11 3041 050	16	25	8	70	✓	✓	29,10
11 3041 055	20	25	6	70	✓	✓	21,85
11 3041 060	20	25	8	70	✓	✓	37,20

- 1
- 2
- 3
- 4
- 5
- 6
- 7
- 8
- 9
- 10



Index

11 5051



**F** FORM / SHAPE **RBF**

Rundbogen

Ball nosed tree

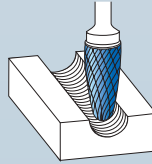

11 3051

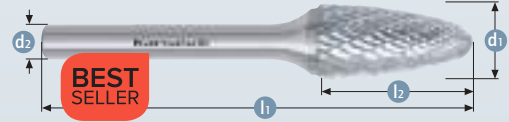

**NEW** VALUETOOL

Schnittdaten Cutting data	Film Movie
753	

Bestseller – preisreduziert · Bestseller – price reduced

Art.	d1	l2	d2	l1	gelötet brazed	VHM solid	€
11 5051 007	• 3	6	3	38	✓		7,60
11 5051 010	• 3	8	3	38		✓	7,60
11 5051 015	• 3	14	3	38		✓	7,60
11 5051 020	• 3	14	3	50		✓	9,90
11 5051 021	• 3	14	3	75		✓	10,90
11 5051 022	• 5	12,7	3	38		✓	15,70
11 5051 025	• 6	12	3	44	✓		11,30
11 5051 030	• 6	18	6	50		✓	11,80
11 5051 033	• 6	18	6	168	✓		28,65
11 5051 035	• 8	20	6	65	✓		15,70
11 5051 040	• 10	20	6	65	✓		15,45
11 5051 045	• 10	20	6	170	✓		23,45
11 5051 047	• 11	25	6	70	✓		21,70
11 5051 048	• 12	20	6	65	✓		22,80
11 5051 050	• 12	25	6	70	✓		21,50
11 5051 053	• 12DIN	25	6	70	✓		19,85
11 5051 055	• 12	25	8	70	✓		21,50
11 5051 060	• 12	25	6	175	✓		33,05
11 5051 065	• 16	25	6	70	✓		29,95
11 5051 070	• 16	25	8	70	✓		32,35
11 5051 075	• 20	25	6	70	✓		39,35
11 5051 080	• 20	25	8	70	✓		42,45
11 5051 082	• 20	32	6	77	✓		48,05
11 5051 085	• 20	38	6	83	✓		55,50
11 5051 090	• 20	38	8	83	✓		60,00

Bestseller – preisreduziert · Bestseller – price reduced

Valuetooll – hervorragendes Preis-Leistungs-Verhältnis  
Valuetooll – excellent price-performance ratio

Art.	d1	l2	d2	l1	gelötet brazed	VHM solid	€
11 3051 007	• 3	6	3	38	✓		5,80
11 3051 010	• 3	8	3	38		✓	5,80
11 3051 015	• 3	14	3	38		✓	5,80
11 3051 016	• 3	14	3	38		✓	3,95 <b>NEW</b>
11 3051 020	• 3	14	3	50		✓	8,10
11 3051 022	• 5	12,7	3	38		✓	13,95
11 3051 025	• 6	12	3	44	✓		9,50
11 3051 030	• 6	18	6	50		✓	10,00
11 3051 031	• 6	18	6	50		✓	7,55 <b>NEW</b>
11 3051 033	• 6	18	6	168	✓		25,85
11 3051 035	• 8	20	6	65	✓		13,95
11 3051 036	• 8	20	6	65	✓		9,65 <b>NEW</b>
11 3051 040	• 10	20	6	65	✓		12,55
11 3051 041	• 10	20	6	65	✓		9,50 <b>NEW</b>
11 3051 045	• 10	20	6	170	✓		17,65
11 3051 047	• 11	25	6	70	✓		17,50
11 3051 048	• 12	20	6	65	✓		18,60
11 3051 050	• 12	25	6	70	✓		17,30
11 3051 053	• 12DIN	25	6	70	✓		15,65
11 3051 054	• 12DIN	25	6	70	✓		12,80 <b>NEW</b>
11 3051 055	• 12	25	8	70	✓		17,30
11 3051 060	• 12	25	6	175	✓		26,00
11 3051 065	• 16	25	6	70	✓		25,75
11 3051 066	• 16	25	6	70	✓		19,35 <b>NEW</b>
11 3051 070	• 16	25	8	70	✓		28,15
11 3051 075	• 20	25	6	70	✓		33,85
11 3051 080	• 20	25	8	70	✓		36,95
11 3051 082	• 20	32	6	77	✓		42,55
11 3051 085	• 20	38	6	83	✓		50,00
11 3051 090	• 20	38	8	83	✓		54,55



11 5061



G FORM / SHAPE

SPG



Spitzbogen

Tree

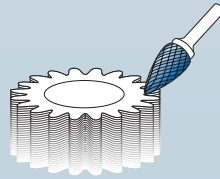

Schnittdaten  
Cutting data

Film  
Movie



11 3061



Bestseller – preisreduziert · Bestseller – price reduced

Art.	d1	l2	d2	l1	gelötet brazed	VHM solid	€
11 5061 010	• 3	6	3	38		✓	7,60
11 5061 012	• 3	10	3	38		✓	7,60
11 5061 015	• 3	14	3	38		✓	7,60
11 5061 020	• 3	14	3	50		✓	9,05
11 5061 025	• 3	14	3	75		✓	10,70
11 5061 028	• 5	12,7	3	38		✓	15,70
11 5061 030	• 6	12	3	44	✓		11,30
11 5061 035	• 6	18	6	50		✓	11,80
11 5061 040	• 8	20	6	65	✓		13,85
11 5061 045	• 10	20	6	65	✓		16,30
11 5061 050	• 10	20	6	170	✓		24,55
11 5061 055	• 12	20	6	65	✓		22,50
11 5061 060	• 12	25	6	70	✓		22,50
11 5061 063	• 12DIN	25	6	70	✓		20,70
11 5061 065	• 12	25	8	70	✓		24,15
11 5061 070	• 12	25	6	175	✓		32,75
11 5061 075	• 12	30	6	75	✓		26,25
11 5061 080	• 12	30	8	75	✓		26,25
11 5061 085	• 16	25	6	70	✓		29,55
11 5061 090	• 16	25	8	70	✓		31,55
11 5061 095	• 16	30	6	75	✓		38,90
11 5061 100	• 16	30	8	75	✓		38,90
11 5061 105	• 20	25	6	70	✓		39,35
11 5061 110	• 20	25	8	70	✓		41,30
11 5061 115	• 20	38	6	83	✓		55,50
11 5061 120	• 20	38	8	83	✓		35,80

Bestseller – preisreduziert · Bestseller – price reduced

Valuetool – hervorragendes Preis-Leistungs-Verhältnis  
Valuetool – excellent price-performance ratio

Art.	d1	l2	d2	l1	gelötet brazed	VHM solid	€
11 3061 010	• 3	6	3	38		✓	5,80
11 3061 012	• 3	10	3	38		✓	5,80
11 3061 015	• 3	14	3	38		✓	5,80
11 3061 016	• 3	14	3	38		✓	3,95
11 3061 020	• 3	14	3	50		✓	7,30
11 3061 028	• 5	12,7	3	38		✓	13,95
11 3061 030	• 6	12	3	44	✓		9,50
11 3061 035	• 6	18	6	50		✓	10,00
11 3061 036	• 6	18	6	50		✓	7,55
11 3061 040	• 8	20	6	65	✓		12,10
11 3061 041	• 8	20	6	65	✓		9,15
11 3061 045	• 10	20	6	65	✓		13,40
11 3061 046	• 10	20	6	65	✓		10,15
11 3061 050	• 10	20	6	170	✓		18,75
11 3061 055	• 12	20	6	65	✓		18,30
11 3061 060	• 12	25	6	70	✓		18,30
11 3061 063	• 12DIN	25	6	70	✓		16,45
11 3061 064	• 12DIN	25	6	70	✓		12,55
11 3061 065	• 12	25	8	70	✓		19,95
11 3061 070	• 12	25	6	175	✓		25,70
11 3061 075	• 12	30	6	75	✓		22,05
11 3061 080	• 12	30	8	75	✓		22,05
11 3061 085	• 16	25	6	70	✓		25,35
11 3061 086	• 16	25	6	70	✓		19,10
11 3061 090	• 16	25	8	70	✓		27,35
11 3061 095	• 16	30	6	75	✓		34,70
11 3061 100	• 16	30	8	75	✓		34,70
11 3061 105	• 20	25	6	70	✓		33,85
11 3061 110	• 20	25	8	70	✓		22,25
11 3061 115	• 20	38	6	83	✓		50,00
11 3061 120	• 20	38	8	83	✓		32,45

- 1
- 2
- 3
- 4
- 5
- 6
- 7
- 8
- 9
- 10



Index



11 5071

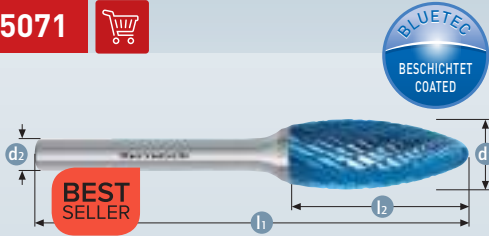

## H FORM / SHAPE

Flamme

Flame

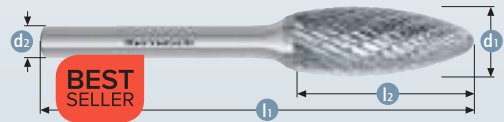
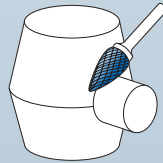

11 3071

NEW VALUETOOL

Schnittdaten Cutting data

Film Movie

753

Bestseller – preisreduziert · Bestseller – price reduced

Art.	d1	l2	d2	l1	gelötet brazed	VHM solid	€
11 5071 003	3	6	3	50	✓	✓	9,35
11 5071 005	3	6	3	38	✓	✓	7,60
11 5071 006	3	6	3	75	✓	✓	11,10
11 5071 007	5	9,5	3	38	✓	✓	15,70
11 5071 010	6	14	6	50	✓	✓	15,05
11 5071 015	8	20	6	65	✓	✓	15,00
11 5071 017	8	20	6	170	✓	✓	25,20
11 5071 020	10	20	6	65	✓	✓	27,45
11 5071 025	12	32	6	77	✓	✓	32,35
11 5071 027	12DIN	30	6	75	✓	✓	29,60
11 5071 028	12	32	6	180	✓	✓	36,25
11 5071 030	12	32	8	77	✓	✓	32,35
11 5071 035	16	36	6	82	✓	✓	41,45
11 5071 040	16	36	8	82	✓	✓	43,40
11 5071 045	20	41	6	86	✓	✓	52,80
11 5071 050	20	41	8	86	✓	✓	54,75

Bestseller – preisreduziert · Bestseller – price reduced

Valuetool – hervorragendes Preis-Leistungs-Verhältnis  
Valuetool – excellent price-performance ratio

Art.	d1	l2	d2	l1	gelötet brazed	VHM solid	€
11 3071 003	3	6	3	50	✓	✓	7,60
11 3071 004	3	6	3	38	✓	✓	3,95
11 3071 005	3	6	3	38	✓	✓	5,80
11 3071 006	3	6	3	75	✓	✓	9,35
11 3071 007	5	9,5	3	38	✓	✓	13,95
11 3071 010	6	14	6	50	✓	✓	13,30
11 3071 011	6	14	6	50	✓	✓	8,20
11 3071 015	8	20	6	65	✓	✓	13,25
11 3071 016	8	20	6	65	✓	✓	9,95
11 3071 017	8	20	6	170	✓	✓	22,35
11 3071 020	10	20	6	65	✓	✓	24,55
11 3071 021	10	20	6	65	✓	✓	13,40
11 3071 025	12	32	6	77	✓	✓	28,15
11 3071 026	12DIN	30	6	75	✓	✓	18,50
11 3071 027	12DIN	30	6	75	✓	✓	25,35
11 3071 028	12	32	6	180	✓	✓	29,20
11 3071 030	12	32	8	77	✓	✓	28,15
11 3071 035	16	36	6	82	✓	✓	37,25
11 3071 036	16	36	6	82	✓	✓	28,00
11 3071 040	16	36	8	82	✓	✓	39,20
11 3071 045	20	41	6	86	✓	✓	47,35
11 3071 050	20	41	8	86	✓	✓	49,25

11 5081

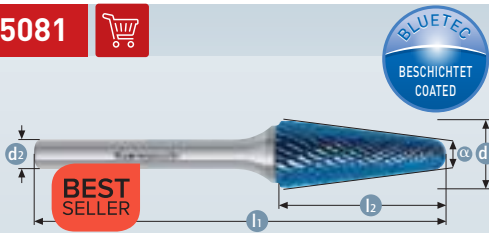

## L FORM / SHAPE KEL

Rundkegel

Ball nosed cone

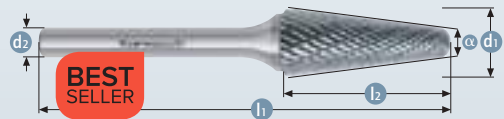
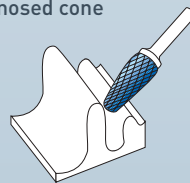

11 3081

NEW VALUETOOL

Schnittdaten Cutting data

Film Movie

753

Bestseller – preisreduziert · Bestseller – price reduced

Art.	d1	l2	d2	l1	gelötet brazed	VHM solid	α°	€
11 5081 005	3	10	3	38	✓	✓	10°	7,60
11 5081 009	3	14	3	50	✓	✓	8°	9,35
11 5081 010	3	14	3	38	✓	✓	8°	7,60
11 5081 011	3	14	3	75	✓	✓	8°	11,10
11 5081 012	5	12,7	3	38	✓	✓	14°	15,70
11 5081 015	6	16	3	48	✓	✓	22°	12,20
11 5081 020	6	18	6	50	✓	✓	14°	12,00
11 5081 025	8	25	6	70	✓	✓	14°	15,15
11 5081 030	10	20	6	65	✓	✓	14°	20,65
11 5081 035	10	30	6	75	✓	✓	14°	19,00
11 5081 040	10	30	6	176	✓	✓	14°	28,30
11 5081 045	12	32	6	77	✓	✓	14°	24,75
11 5081 047	12DIN	25	6	70	✓	✓	14°	22,75
11 5081 050	12	32	8	77	✓	✓	14°	24,75
11 5081 055	12	32	6	182	✓	✓	14°	36,85
11 5081 060	16	33	6	78	✓	✓	14°	35,95
11 5081 065	16	33	8	78	✓	✓	14°	35,95
11 5081 070	20	41	6	86	✓	✓	14°	47,40
11 5081 075	20	41	8	86	✓	✓	14°	47,40

Bestseller – preisreduziert · Bestseller – price reduced

Valuetool – hervorragendes Preis-Leistungs-Verhältnis  
Valuetool – excellent price-performance ratio

Art.	d1	l2	d2	l1	gelötet brazed	VHM solid	α°	€
11 3081 005	3	10	3	38	✓	✓	10°	5,80
11 3081 008	3	14	3	38	✓	✓	10°	3,95
11 3081 009	3	14	3	50	✓	✓	8°	7,60
11 3081 010	3	14	3	38	✓	✓	8°	5,80
11 3081 011	3	14	3	75	✓	✓	8°	9,35
11 3081 012	5	12,7	3	38	✓	✓	14°	13,95
11 3081 015	6	16	3	48	✓	✓	22°	10,45
11 3081 020	6	18	6	50	✓	✓	14°	10,20
11 3081 021	6	18	6	50	✓	✓	14°	7,70
11 3081 025	8	25	6	70	✓	✓	14°	13,35
11 3081 026	8	25	6	70	✓	✓	14°	10,10
11 3081 030	10	20	6	65	✓	✓	14°	17,80
11 3081 031	10	20	6	65	✓	✓	14°	13,15
11 3081 035	10	30	6	75	✓	✓	14°	16,15
11 3081 040	10	30	6	176	✓	✓	14°	22,50
11 3081 045	12	32	6	77	✓	✓	14°	20,55
11 3081 047	12DIN	25	6	70	✓	✓	14°	18,55
11 3081 048	12DIN	25	6	70	✓	✓	14°	13,50
11 3081 050	12	32	8	77	✓	✓	14°	20,55
11 3081 055	12	32	6	182	✓	✓	14°	29,80
11 3081 060	16	33	6	78	✓	✓	14°	31,75
11 3081 061	16	33	6	78	✓	✓	14°	24,40
11 3081 065	16	33	8	78	✓	✓	14°	31,75
11 3081 070	20	41	6	86	✓	✓	14°	41,95
11 3081 075	20	41	8	86	✓	✓	14°	41,95

⊘ Sonderpreis / Sale Artikel. Lieferbar solange Vorrat.  
Special price / sale article. While stocks last.



11 5091



BEST SELLER

M FORM / SHAPE

SKM

Spitzkegel

Cone

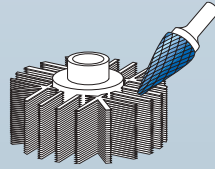

11 3091

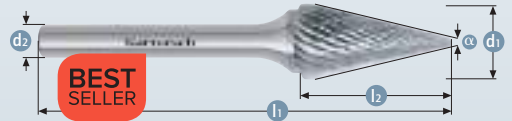

BEST SELLER

NEW VALUETOOL

Schnittdaten Cutting data

Film Movie



Bestseller – preisreduziert · Bestseller – price reduced

Art.	d1	l2	d2	l1	gelötet brazed	VHM solid	α°	€
11 5091 010	3	8	3	38		✓	18°	7,60
11 5091 015	3	11	3	38		✓	14°	7,60
11 5091 020	3	15	3	38		✓	10°	7,60
11 5091 025	6	12	3	48	✓	✓	22°	11,30
11 5091 027	6	12,7	6	50	✓	✓	14°	11,45
11 5091 030	6	20	6	50	✓	✓	14°	12,00
11 5091 032	6	25	6	50	✓	✓	11°	12,70
11 5091 035	8	18	6	63	✓	✓	13°	15,15
11 5091 040	10	20	6	65	✓	✓	28°	19,45
11 5091 045	12	25	6	70	✓	✓	28°	24,15
11 5091 047	12DIN	25	6	70	✓	✓	28°	23,55
11 5091 050	12	25	8	70	✓	✓	28°	24,15
11 5091 055	16	26	6	74	✓	✓	33°	31,15
11 5091 060	16	26	8	74	✓	✓	33°	33,95

Bestseller – preisreduziert · Bestseller – price reduced

Valuetool – hervorragendes Preis-Leistungs-Verhältnis  
Valuetool – excellent price-performance ratio

Art.	d1	l2	d2	l1	gelötet brazed	VHM solid	α°	€
11 3091 010	3	8	3	38		✓	18°	5,80
11 3091 015	3	11	3	38		✓	14°	5,80
11 3091 016	3	11	3	38		✓	14°	3,95
11 3091 020	3	15	3	38		✓	10°	5,80
11 3091 025	6	12	3	48	✓	✓	22°	9,50
11 3091 027	6	12,7	6	50	✓	✓	14°	9,70
11 3091 030	6	20	6	50	✓	✓	14°	10,20
11 3091 031	6	20	6	50	✓	✓	14°	7,70
11 3091 032	6	25	6	50	✓	✓	11°	10,95
11 3091 035	8	18	6	63	✓	✓	13°	13,35
11 3091 036	8	18	6	63	✓	✓	13°	10,30
11 3091 040	10	20	6	65	✓	✓	28°	16,55
11 3091 041	10	20	6	65	✓	✓	28°	12,15
11 3091 045	12	25	6	70	✓	✓	28°	19,95
11 3091 047	12DIN	25	6	70	✓	✓	28°	18,00
11 3091 048	12DIN	25	6	70	✓	✓	28°	13,85
11 3091 050	12	25	8	70	✓	✓	28°	19,95
11 3091 055	16	26	6	74	✓	✓	33°	26,95
11 3091 056	16	26	6	74	✓	✓	33°	20,25
11 3091 060	16	26	8	74	✓	✓	33°	29,75

11 5096



BEST SELLER

N FORM / SHAPE

WKN

Winkel

Inverted cone

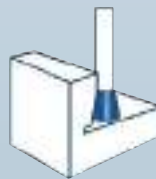

11 3096



BEST SELLER

Schnittdaten Cutting data

Film Movie



Bestseller – preisreduziert · Bestseller – price reduced

Art.	d1	l2	d2	l1	gelötet brazed	VHM solid	α°	€
11 5096 005	3	5	3	38		✓	10°	7,45
11 5096 010	6	7	3	39	✓	✓	10°	11,30
11 5096 015	6	8	6	50	✓	✓	10°	11,50
11 5096 020	10	10	6	55	✓	✓	13°	17,10
11 5096 025	12	13	6	58	✓	✓	30°	24,35
11 5096 030	12	13	8	58	✓	✓	30°	26,45
11 5096 035	16	19	6	64	✓	✓	18°	30,05
11 5096 040	16	19	8	64	✓	✓	18°	32,05
11 5096 045	20	16	6	61	✓	✓	30°	34,50

Bestseller – preisreduziert · Bestseller – price reduced

Art.	d1	l2	d2	l1	gelötet brazed	VHM solid	α°	€
11 3096 005	3	5	3	38		✓	10°	5,70
11 3096 010	6	7	3	39	✓	✓	10°	9,50
11 3096 015	6	8	6	50	✓	✓	10°	9,75
11 3096 020	10	10	6	55	✓	✓	13°	14,20
11 3096 025	12	13	6	58	✓	✓	30°	20,15
11 3096 030	12	13	8	58	✓	✓	30°	22,25
11 3096 035	16	19	6	64	✓	✓	18°	25,85
11 3096 040	16	19	8	64	✓	✓	18°	27,85
11 3096 045	20	16	6	61	✓	✓	30°	29,00

- 1
- 2
- 3
- 4
- 5
- 6
- 7
- 8
- 9
- 10

11 5101

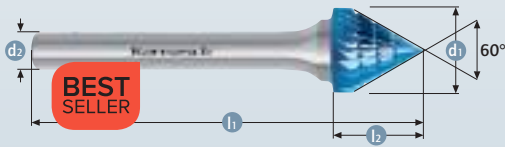

**BEST SELLER**

## J FORM / SHAPE KSJ

Kegel 60°

Countersink 60°

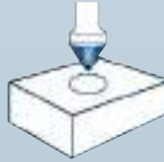

11 3101

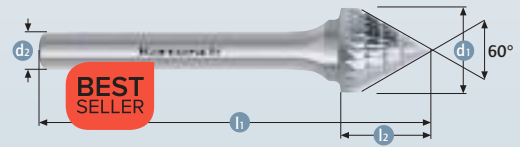

**BEST SELLER**

Schnittdaten Cutting data	Film Movie
753	

Bestseller – preisreduziert · Bestseller – price reduced

Art.	d1	l2	d2	l1	gelötet brazed	VHM solid	€
11 5101 005	• 3	3	3	38		✓	7,60
11 5101 010	• 6	6	6	50		✓	10,55
11 5101 015	• 10	8	6	56	✓		14,45
11 5101 020	• 12	11	6	60	✓		18,20
11 5101 025	• 16	15	6	62	✓		22,80
11 5101 030	• 16	15	8	62	✓		24,80
11 5101 035	• 20	17	6	65	✓		29,90
11 5101 040	• 25	24,5	6	68	✓		44,70

Bestseller – preisreduziert · Bestseller – price reduced

Art.	d1	l2	d2	l1	gelötet brazed	VHM solid	€
11 3101 005	• 3	3	3	38		✓	5,80
11 3101 010	• 6	6	6	50		✓	8,75
11 3101 015	• 10	8	6	56	✓		11,55
11 3101 020	• 12	11	6	60	✓		13,95
11 3101 025	• 16	15	6	62	✓		18,60
11 3101 035	• 20	17	6	65	✓		12,75
11 3101 040	• 25	24,5	6	68	✓		39,20

11 5111



**BEST SELLER**

## K FORM / SHAPE KSK

Kegel 90°

Countersink 90°

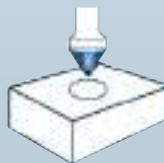

11 3111



**BEST SELLER**

Schnittdaten Cutting data	Film Movie
753	

Bestseller – preisreduziert · Bestseller – price reduced

Art.	d1	l2	d2	l1	gelötet brazed	VHM solid	€
11 5111 005	• 3	3	3	38		✓	7,60
11 5111 010	• 6	3	6	50		✓	10,55
11 5111 015	• 10	5	6	53	✓		14,45
11 5111 020	• 12	7	6	55	✓		18,20
11 5111 025	• 12	7	8	55	✓		19,75
11 5111 030	• 16	8	6	57	✓		22,80
11 5111 035	• 16	8	8	57	✓		24,80
11 5111 040	• 20	12	6	60	✓		29,90
11 5111 045	• 25	12,7	6	60	✓		44,70

Bestseller – preisreduziert · Bestseller – price reduced

Art.	d1	l2	d2	l1	gelötet brazed	VHM solid	€
11 3111 005	• 3	3	3	38		✓	5,80
11 3111 010	• 6	3	6	50		✓	8,75
11 3111 015	• 10	5	6	53	✓		11,55
11 3111 020	• 12	7	6	55	✓		13,95
11 3111 025	• 12	7	8	55	✓		15,55
11 3111 030	• 16	8	6	57	✓		18,60
11 3111 035	• 16	8	8	57	✓		20,55
11 3111 040	• 20	12	6	60	✓		24,45
11 3111 045	• 25	12,7	6	60	✓		39,20

⊘ Sonderpreis / Sale Artikel. Lieferbar solange Vorrat.  
Special price / sale article. While stocks last.



# HP-2

Die am meisten verwendete Einfachverzähnung  
The most widely used single cutting style

## ANWENDUNG · APPLICATION













 Stahl Steel	 Gehärteter Stahl Hardened steel	 Edelstahl Stainless	 Gusseisen Cast iron	 Titan Titanium	 Cermet Cermet	 Nickel Nickel	 Kupfer, Kupferlegierungen Copper, copper alloys	 Alu Alu	 Kunststoffe GFK/CFK Plastics GRP/CRP	
✓	✓	✓	✓	✓	✓	✓	✓	✓	✓	✓

✓ OPTIMAL  
OPTIMAL  
✓ GUT  
GOOD

- Hohe Zerspanleistung mit guter Oberflächengüte
- Für alle Stahlsorten wie:
  - Gusseisen
  - Stahl < 60 HRC
  - Edelstahl (INOX)
  - Nickelbasis- und Titanlegierungen
- Auch Kupfer, Messing, Bronze

- High cutting action with good surface finish
- For use on all ferrous metals such as:
  - Cast iron
  - Steel < 60 HRC
  - Stainless steel (INOX)
  - Nickel basis and titanium alloy
- Also copper, brass, bronze

## Lagerprogramm + Katalogseiten • Stockrange + catalogue pages

ZYA	ZYB	WRC	KUD	TRE	RBF	SPG	-	KEL	SKM	WKN	KSJ	KSK
A	B	C	D	E	F	G	H	L	M	N	J	K
Art. 11 5000 Art. 11 3000	Art. 11 5010 Art. 11 3010	Art. 11 5020 Art. 11 3020	Art. 11 5030 Art. 11 3030	Art. 11 5040 Art. 11 3040	Art. 11 5050 Art. 11 3050	Art. 11 5060 Art. 11 3060	Art. 11 5070 Art. 11 3070	Art. 11 5080 Art. 11 3080	Art. 11 5090 Art. 11 3090	Art. 11 5099 Art. 11 3099	Art. 11 5100 Art. 11 3100	Art. 11 5110 Art. 11 3110
												
768	768	769	769	770	770	771	771	772	772	773	773	774
Zylinder Cylinder	Zylinder + Stirnverzähnung Cylinder + end cut	Walzenrundform Ball nosed cylinder	Kugel Ball	Tropfen Oval	Rundbogen Ball nosed tree	Spitzbogen Tree	Flamme Flame	Rundkegel Ball nosed cone	Spitzkegel Cone	Winkel Inverted cone	Kegel 60° Countersink 60°	Kegel 90° Countersink 90°



BLUE-TEC-beschichtet  
BLUE-TEC-coated



Die für Frässtifte optimierte und patentierte BLUE-TEC-Beschichtung ergibt einzigartige Standzeiten und Performance in allen Stahlsorten.

Patented BLUE-TEC coating, specifically designed for burrs, gives outstanding tool life and excellent performance on all metals.

Werkstoffgruppen			Bearbeitung	Schnittgeschwindigkeit (m/min)
Stahl, Stahlguss	Ungehärtete, nicht vergütete Stähle bis 1200 N/mm <sup>2</sup> (< 38 HRC)	Baustähle, Kohlenstoffstähle, Werkzeugstähle, unlegierte Stähle, Einsatzstähle, Stahlguss	Grobes Zerspanen mit hohem Materialabtrag	450-600
	Gehärtete, vergütete Stähle über 1200 N/mm <sup>2</sup> (> 38 HRC)	Werkzeugstähle, Vergütungsstähle, legierte Stähle, Stahlguss		250-350
Edelstahl (INOX)	Rost- und säurebeständige Stähle	Austenitische und ferritische Edelstähle	Grobes Zerspanen mit hohem Materialabtrag	250-350
NE-Metalle	Harte NE-Metalle	Bronze, Titan/Titanlegierungen, harte Alulegierungen (hoher Si-Anteil)	Grobes Zerspanen mit hohem Materialabtrag	250-350
	Hochwarmfeste Werkstoffe	Nickelbasis- und Kobaltbasislegierungen (Triebwerk- und Turbinenbau)		300-450
Gusseisen	Graues Gusseisen, weißes Gusseisen	Gusseisen mit Lamellengraphit EN-GJL (GG), mit Kugelgraphit/Späroguss EN-GJS (GGG), weißer Temperguss EN-GJMW (GTW), schwarzer Temperguss EN-GJMB (GTS)	Grobes Zerspanen mit hohem Materialabtrag	450-600

Material groups			Application	Cutting speed m/min
Steel, cast steel	Non-hardened, non-heat treated steels up to 1200 N/mm <sup>2</sup> (< 38 HRC)	Construction steels, carbon steels, tool steels, non-alloyed steels, case-hardened steels, cast steels	Coarse machining with high stock removal	450-600
	Hardened, heat-treated steels exceeding 1200 N/mm <sup>2</sup> (> 38 HRC)	Tool steels, tempering steels, alloyed steel, cast steels		250-350
Stainless steel (INOX)	Rust and acid-resistant steels	Austenitic and ferritic stainless steels	Coarse machining with high stock removal	250-350
Non-ferrous metals	Hard-non-ferrous metals	Bronze, titanium/titanium alloys, hard alu-alloys (high Si content)	Coarse machining with high stock removal	250-350
	High-temperature resistant materials	Nickel based alloys, cobalt based alloys (aircraft engine and turbine construction)		300-450
Cast iron	Grey cast iron, white cast iron	Cast iron with flake graphite EN-GJL, with nodular graphite cast iron EN-GJS, white annealed cast iron EN-GJMW, black cast iron EN-GJMB	Coarse machining with high stock removal	450-600



Schnittgeschwindigkeit • Cutting speed (m/min)							
	250	300	350	400	450	500	600
∅ (mm)	Drehzahlen (min <sup>-1</sup> ) • Rotational speed (rpm)						
2	40.000	48.000	56.000	64.000	72.000	80.000	95.000
3	27.000	32.000	37.000	42.000	48.000	53.000	64.000
4	20.000	24.000	28.000	32.000	36.000	40.000	48.000
6	13.000	16.000	19.000	21.000	24.000	27.000	32.000
8	10.000	12.000	14.000	16.000	18.000	20.000	24.000
10	8.000	10.000	11.000	13.000	14.000	16.000	19.000
12	7.000	8.000	9.000	11.000	12.000	13.000	16.000
16	5.000	6.000	7.000	8.000	9.000	10.000	12.000
20	4.000	5.000	6.000	6.000	7.000	8.000	10.000
25	3.000	4.000	4.000	5.000	6.000	6.000	8.000



11 5000



**A FORM / SHAPE ZYA**



Zylinder ohne Stirnverzahnung

Cylindrical without end cut

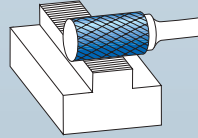

Schnittdaten  
Cutting data

Film  
Movie



Art.	d1	l2	d2	l1	gelötet brazed	VHM solid	€
11 5000 030	• 3	14	3	38		✓	8,70
11 5000 060	• 6	13	3	45	✓		13,90
11 5000 065	• 6	18	6	50		✓	11,75
11 5000 080	• 8	20	6	65	✓		14,45
11 5000 090	• 10	20	6	65	✓		16,90
11 5000 105	• 12	25	6	70	✓		25,95

Art.	d1	l2	d2	l1	gelötet brazed	VHM solid	€
11 3000 030	• 3	14	3	38		✓	6,65
11 3000 060	• 6	13	3	45	✓		11,80
11 3000 065	• 6	18	6	50		✓	9,70
11 3000 080	• 8	20	6	65	✓		12,40
11 3000 090	• 10	20	6	65	✓		13,55
11 3000 105	• 12	25	6	70	✓		21,05

11 5010



**B FORM / SHAPE ZYB**

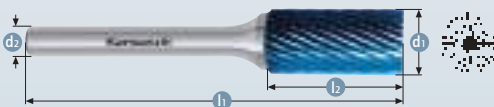

Zylinder mit Stirnverzahnung

Cylindrical with end cut

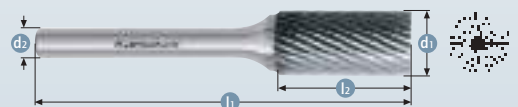
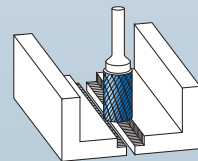

Schnittdaten  
Cutting data

Film  
Movie



Art.	d1	l2	d2	l1	gelötet brazed	VHM solid	€
11 5010 015	• 3	14	3	38		✓	8,80
11 5010 045	• 6	13	3	45	✓		15,10
11 5010 050	• 6	18	6	50		✓	12,50
11 5010 070	• 6	25	6	50		✓	17,20
11 5010 075	• 8	20	6	65	✓		15,85
11 5010 085	• 10	20	6	65	✓		18,20
11 5010 100	• 12	25	6	70	✓		27,10

Art.	d1	l2	d2	l1	gelötet brazed	VHM solid	€
11 3010 015	• 3	14	3	38		✓	6,75
11 3010 045	• 6	13	3	45	✓		13,00
11 3010 050	• 6	18	6	50		✓	10,40
11 3010 070	• 6	25	6	50		✓	15,15
11 3010 075	• 8	20	6	65	✓		13,80
11 3010 085	• 10	20	6	65	✓		14,85
11 3010 100	• 12	25	6	70	✓		22,20



11 5020



## C FORM / SHAPE WRC

Walzenrundform  
Ball nosed cylinder

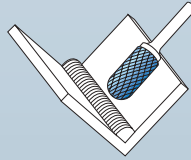

Schnittdaten  
Cutting data

767

Film  
Movie

Art.	d1	l2	d2	l1	gelötet brazed	VHM solid	€
11 5020 022	• 2,5	11	3	38		✓	8,70
11 5020 025	• 3	14	3	38		✓	8,70
11 5020 050	• 6	12,7	3	44	✓		13,15
11 5020 055	• 6	18	6	50		✓	13,25
11 5020 075	• 8	20	6	65	✓		15,75
11 5020 085	• 10	20	6	65	✓		18,25
11 5020 105	• 12	25	6	70	✓		28,25

Art.	d1	l2	d2	l1	gelötet brazed	VHM solid	€
11 3020 022	• 2,5	11	3	38		✓	3,55
11 3020 025	• 3	14	3	38		✓	6,65
11 3020 050	• 6	12,7	3	44	✓		11,10
11 3020 055	• 6	18	6	50		✓	11,15
11 3020 075	• 8	20	6	65	✓		13,70
11 3020 085	• 10	20	6	65	✓		14,85
11 3020 105	• 12	25	6	70	✓		23,35

11 5030

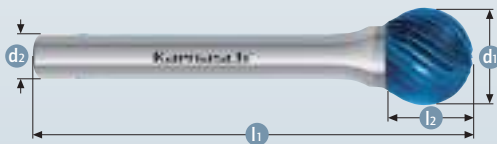

## D FORM / SHAPE KUD

Kugel  
Ball

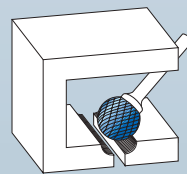

Schnittdaten  
Cutting data

767

Film  
Movie

Art.	d1	l2	d2	l1	gelötet brazed	VHM solid	€
11 5030 025	• 3	2,5	3	38		✓	8,70
11 5030 045	• 4	3,4	3	38		✓	18,30
11 5030 047	• 5	4,7	3	38		✓	18,15
11 5030 048	• 5	4,0	6	50		✓	12,20
11 5030 050	• 6	5,0	3	38	✓		11,95
11 5030 055	• 6	4,7	6	50		✓	12,30
11 5030 060	• 8	7,0	6	52	✓		13,10
11 5030 070	• 10	8,0	6	54	✓		15,70
11 5030 080	• 12	11,0	6	56	✓		21,50

Art.	d1	l2	d2	l1	gelötet brazed	VHM solid	€
11 3030 025	• 3	2,5	3	38		✓	6,65
11 3030 045	• 4	3,4	3	38		✓	16,25
11 3030 047	• 5	4,7	3	38		✓	16,05
11 3030 048	• 5	4,0	6	50		✓	10,15
11 3030 050	• 6	5,0	3	38	✓		9,90
11 3030 055	• 6	4,7	6	50		✓	10,20
11 3030 060	• 8	7,0	6	52	✓		11,05
11 3030 070	• 10	8,0	6	54	✓		12,35
11 3030 080	• 12	11,0	6	56	✓		16,60

• Sonderpreis / Sale Artikel. Lieferbar solange Vorrat.  
Special price / sale article. While stocks last.



11 5040



E FORM / SHAPE TRE



Tropfen

Oval

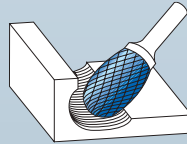

Schnittdaten  
Cutting data

Film  
Movie



Art.	d1	l2	d2	l1	gelötet brazed	VHM solid	€
11 5040 010	• 3	6	3	38		✓	8,70
11 5040 015	• 6	10	3	42	✓		13,15
11 5040 020	• 6	10	6	50		✓	14,65
11 5040 025	• 8	15	6	60	✓		16,80
11 5040 030	• 10	16	6	60	✓		18,40
11 5040 035	• 12	22	6	67	✓		26,85

Art.	d1	l2	d2	l1	gelötet brazed	VHM solid	€
11 3040 010	• 3	6	3	38		✓	3,60
11 3040 015	• 6	10	3	42	✓		6,05
11 3040 020	• 6	10	6	50		✓	6,85
11 3040 025	• 8	15	6	60	✓		8,00
11 3040 030	• 10	16	6	60	✓		8,15
11 3040 035	• 12	22	6	67	✓		11,95

11 5050



F FORM / SHAPE RBF

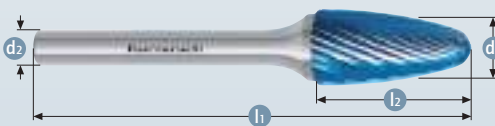

Rundbogen

Ball nosed tree

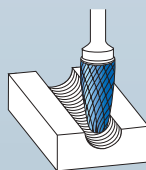

Schnittdaten  
Cutting data

Film  
Movie



Art.	d1	l2	d2	l1	gelötet brazed	VHM solid	€
11 5050 015	• 3	14	3	38		✓	8,70
11 5050 025	• 6	12	3	44	✓		13,00
11 5050 030	• 6	18	6	50		✓	13,75
11 5050 035	• 8	20	6	65	✓		17,85
11 5050 040	• 10	20	6	65	✓		18,00
11 5050 050	• 12	25	6	70	✓		26,60

Art.	d1	l2	d2	l1	gelötet brazed	VHM solid	€
11 3050 015	• 3	14	3	38		✓	6,65
11 3050 025	• 6	12	3	44	✓		10,90
11 3050 030	• 6	18	6	50		✓	11,70
11 3050 035	• 8	20	6	65	✓		15,75
11 3050 040	• 10	20	6	65	✓		14,65
11 3050 050	• 12	25	6	70	✓		21,70





11 5060



## G FORM / SHAPE SPG

Spitzbogen

Tree

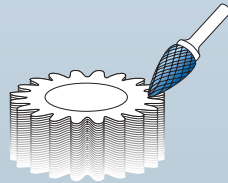

Schnittdaten Cutting data	Film Movie
767	

Art.	d1	l2	d2	l1	gelötet brazed	VHM solid	€
11 5060 012	• 3	10	3	38		✓	8,70
11 5060 015	• 3	14	3	38		✓	8,70
11 5060 030	• 6	12	3	44	✓		13,00
11 5060 035	• 6	18	6	50		✓	13,75
11 5060 040	• 8	20	6	65	✓		16,05
11 5060 045	• 10	20	6	65	✓		18,80
11 5060 060	• 12	25	6	70	✓		26,00

Art.	d1	l2	d2	l1	gelötet brazed	VHM solid	€
11 3060 012	• 3	10	3	38		✓	6,65
11 3060 015	• 3	14	3	38		✓	6,65
11 3060 030	• 6	12	3	44	✓		10,90
11 3060 035	• 6	18	6	50		✓	11,70
11 3060 040	• 8	20	6	65	✓		14,00
11 3060 045	• 10	20	6	65	✓		15,45
11 3060 060	• 12	25	6	70	✓		21,10

11 5070

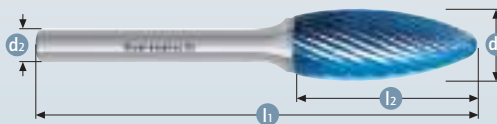

## H FORM / SHAPE

Flamme

Flame

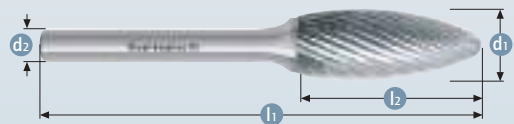
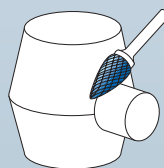

Schnittdaten Cutting data	Film Movie
767	

Art.	d1	l2	d2	l1	gelötet brazed	VHM solid	€
11 5070 005	• 3	6	3	38		✓	8,80
11 5070 015	• 8	20	6	65	✓		17,50
11 5070 020	• 10	20	6	65	✓		31,10
11 5070 025	• 12	32	6	77	✓		36,70

Art.	d1	l2	d2	l1	gelötet brazed	VHM solid	€
11 3070 005	• 3	6	3	38		✓	6,70
11 3070 015	• 8	20	6	65	✓		15,45
11 3070 020	• 10	20	6	65	✓		27,75
11 3070 025	• 12	32	6	77	✓		31,80



11 5080



L FORM / SHAPE KEL

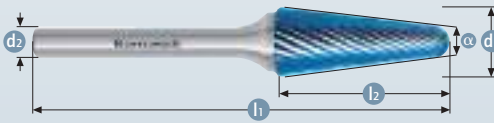

Rundkegel

Ball nosed cone

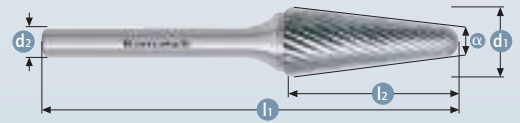
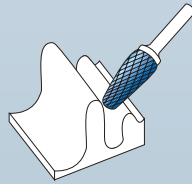

Schnittdaten  
Cutting data

Film  
Movie



Art.	d1	l2	d2	l1	gelötet brazed	VHM solid	α°	€
11 5080 010	• 3	14	3	38		✓	8°	8,70
11 5080 015	• 6	16	3	48	✓		22°	13,90
11 5080 020	• 6	18	6	50		✓	14°	13,85
11 5080 025	• 8	25	6	70	✓		14°	17,65
11 5080 030	• 10	20	6	65	✓		14°	23,90
11 5080 045	• 12	32	6	77	✓		14°	28,15

Art.	d1	l2	d2	l1	gelötet brazed	VHM solid	α°	€
11 3080 010	• 3	14	3	38		✓	8°	6,65
11 3080 015	• 6	16	3	48	✓		22°	11,80
11 3080 020	• 6	18	6	50		✓	14°	11,80
11 3080 025	• 8	25	6	70	✓		14°	15,60
11 3080 030	• 10	20	6	65	✓		14°	20,55
11 3080 045	• 12	32	6	77	✓		14°	23,25

11 5090



M FORM / SHAPE SKM

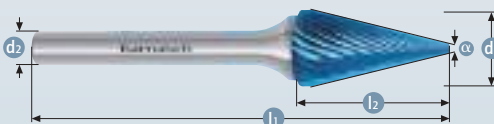

Spitzkegel

Cone

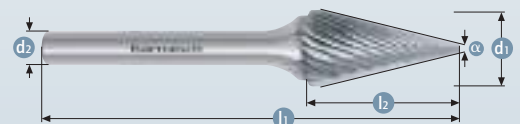
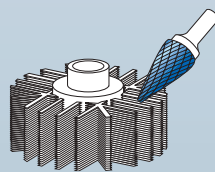

Schnittdaten  
Cutting data

Film  
Movie



Art.	d1	l2	d2	l1	gelötet brazed	VHM solid	α°	€
11 5090 015	• 3	11	3	38		✓	14°	8,70
11 5090 025	• 6	12	3	48	✓		22°	13,15
11 5090 030	• 6	20	6	50		✓	14°	13,85
11 5090 040	• 10	20	6	65	✓		28°	22,10
11 5090 045	• 12	25	6	70	✓		28°	27,45

Art.	d1	l2	d2	l1	gelötet brazed	VHM solid	α°	€
11 3090 015	• 3	11	3	38		✓	14°	6,65
11 3090 025	• 6	12	3	48	✓		22°	11,10
11 3090 030	• 6	20	6	50		✓	14°	11,80
11 3090 040	• 10	20	6	65	✓		28°	18,75
11 3090 045	• 12	25	6	70	✓		28°	22,55



11 5099



## N FORM / SHAPE WKN

Winkel

Inverted cone

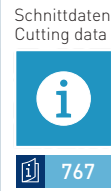
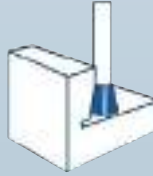

767

Art.	d1	l2	d2	l1	gelötet brazed	VHM solid	α°	€
11 5099 005	• 3	5	3	38		✓	10°	8,80
11 5099 010	• 6	7	3	39	✓		10°	13,15
11 5099 015	• 6	8	6	50		✓	10°	13,45
11 5099 020	• 10	10	6	55	✓		13°	19,75
11 5099 025	• 12	13	6	58	✓		30°	28,40

Art.	d1	l2	d2	l1	gelötet brazed	VHM solid	α°	€
11 3099 005	• 3	5	3	38		✓	10°	6,75
11 3099 010	• 6	7	3	39	✓		10°	11,10
11 3099 015	• 6	8	6	50		✓	10°	11,35
11 3099 020	• 10	10	6	55	✓		13°	16,40
11 3099 025	• 12	13	6	58	✓		30°	23,50

11 5100



## J FORM / SHAPE KSJ

Kegel 60°

Countersink 60°

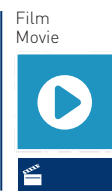
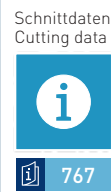
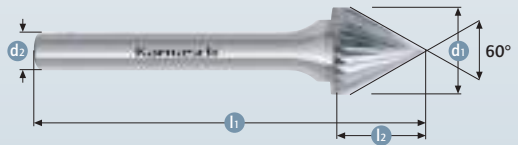
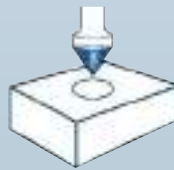

767

Art.	d1	l2	d2	l1	gelötet brazed	VHM solid	€
11 5100 005	• 3	3	3	38		✓	8,70
11 5100 010	• 6	6	6	50		✓	12,20
11 5100 015	• 10	8	6	56	✓		16,85
11 5100 020	• 12	11	6	60	✓		21,20

Art.	d1	l2	d2	l1	gelötet brazed	VHM solid	€
11 3100 005	• 3	3	3	38		✓	6,65
11 3100 010	• 6	6	6	50		✓	10,15
11 3100 015	• 10	8	6	56	✓		13,45
11 3100 020	• 12	11	6	60	✓		16,30

- 1
- 2
- 3
- 4
- 5
- 6
- 7
- 8
- 9
- 10

11 5110



K FORM / SHAPE

KSK



11 3110



Kegel 90°

Countersink 90°

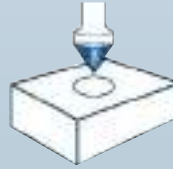

Schnittdaten  
Cutting data

Film  
Movie



Art.	d1	l2	d2	l1	gelötet brazed	VHM solid	€
11 5110 005	• 3	1,5	3	38		✓	8,70
11 5110 010	• 6	3	6	50		✓	12,20
11 5110 015	• 10	5	6	56	✓		16,85
11 5110 020	• 12	7	6	60	✓		21,20

Art.	d1	l2	d2	l1	gelötet brazed	VHM solid	€
11 3110 005	• 3	1,5	3	38		✓	6,65
11 3110 010	• 6	3	6	50		✓	10,15
11 3110 015	• 10	5	6	56	✓		13,45
11 3110 020	• 12	7	6	60	✓		16,30

Qualitätsprodukte für die Metallbearbeitung.  
Quality products for metalworking.

**Karnasch®**  
PROFESSIONAL TOOLS



**VIelfalt**

FÜR PERFEKTION IN JEDER  
GRÖSSENORDNUNG

Versatility for perfection on any scale

DAS KARNASCH PRODUKTSORTIMENT ONLINE!  
THE KARNASCH PRODUCT RANGE ONLINE!

<https://shop.karnasch.tools>

- 1
- 2
- 3
- 4
- 5
- 6
- 7
- 8
- 9
- 10

Qualitätsprodukte für die Metallbearbeitung.  
Quality products for metalworking.



# HOCHLEISTUNG FÜR JEDEN ANWENDUNGSBEREICH

High performance in every application area



**DAS KARNASCH PRODUKTSORTIMENT ONLINE!** Nutzen Sie unseren Onlineshop und profitieren Sie von den speziellen Vorteilen für Onlineshop-Kunden.

**THE KARNASCH PRODUCT RANGE ONLINE!** Use our onlineshop and benefit from the special advantages for onlineshop customers.

 <https://shop.karnasch.tools>

- 1 
- 2 
- 3 
- 4 
- 5 
- 6 
- 7 
- 8 
- 9 
- 10 

# HP-6

## Extrem grobe Kreuzverzahnung Extremely rough cross cutting style











### ANWENDUNG · APPLICATION

 Stahl Steel	 Gehärteter Stahl Hardened steel	 Edelstahl Stainless	 Gusseisen Cast iron	 Titan Titanium	 Cermet Cermet	 Nickel Nickel	 Kupfer, Kupferlegierungen Copper, copper alloys	 Alu Alu	 Kunststoffe GFK/CFK Plastics GRP/CRP	<input checked="" type="checkbox"/> OPTIMAL OPTIMAL	<input checked="" type="checkbox"/> GUT GOOD
---	---	---	---	--	---	--	---	---	--	--	---

- Extrem hoher Materialabtrag (Schuppen)
- Für alle Stahlsorten wie:
  - Gusseisen
  - Stahl < 60 HRC
- Auch für Kupfer, Messing, Bronze
- Für den harten Schruppeinsatz wie z.B. auf Werften, Gießereien entwickelt.

- Extremely fast metal removal (roughing)
- For all ferrous metals, such as:
  - Cast iron
  - Steel < 60 HRC
- Also for copper, brass, bronze
- Developed for use in tough roughing conditions, such as, e.g., on shipyards, foundries.

### Lagerprogramm + Katalogseiten • Stockrange + catalogue pages

ZYA	ZYB	WRC	KUD	TRE	RBF	SPG	-	KEL	SKM
A	B	C	D	E	F	G	H	L	M
Art. 11 5004 Art. 11 5004	Art. 11 5014 Art. 11 3014	Art. 11 5024 Art. 11 3024	Art. 11 5034 Art. 11 3034	Art. 11 5044 Art. 11 3044	Art. 11 5054 Art. 11 3054	Art. 11 5064 Art. 11 3064	Art. 11 5074 Art. 11 3074	Art. 11 5084 Art. 11 3084	Art. 11 5094 Art. 11 3094
									
778	778	779	779	780	780	781	781	782	782
Zylinder Cylinder	Zylinder + Stirnverzahnung Cylinder + end cut	Walzenrundform Ball nosed cylinder	Kugel Ball	Tropfen Oval	Rundbogen Ball nosed tree	Spitzbogen Tree	Flamme Flame	Rundkegel Ball nosed cone	Spitzkegel Cone



BLUE-TEC-beschichtet  
BLUE-TEC-coated

Die für Frässtifte optimierte und patentierte BLUE-TEC-Beschichtung ergibt einzigartige Standzeiten und Performance in allen Stahlsorten.

Patented BLUE-TEC coating, specifically designed for burrs, gives outstanding tool life and excellent performance on all metals.

Werkstoffgruppen			Bearbeitung	Schnittgeschwindigkeit (m/min)
Stahl, Stahlguss	Ungehärtete, nicht vergütete Stähle bis 1200 N/mm <sup>2</sup> (< 38 HRC)	Baustähle, Kohlenstoffstähle, Werkzeugstähle, unlegierte Stähle, Einsatzstähle, Stahlguss	Grobes Zerspanen = hoher Materialabtrag mit Schlagbelastung	250 - 600
	Gehärtete, vergütete Stähle über 1200 N/mm <sup>2</sup> (> 38 HRC)	Werkzeugstähle, Vergütungsstähle, legierte Stähle, Stahlguss		250 - 350
NE-Metalle	Hochwarmfeste Werkstoffe	Nickelbasis- und Kobaltbasislegierungen, (Triebwerk- und Turbinenbau)	Grobes Zerspanen = hoher Materialabtrag mit Schlagbelastung	250 - 450
Gusseisen	Graues Gusseisen, weißes Gusseisen	Gusseisen mit Lamellengraphit EN-GJL (GG), mit Kugelgraphit/ Sphäroguss EN-GJS (GGG), weißer Temperguss EN-GJMW (GTW), schwarzer Temperguss EN-GJMB (GTS)	Grobes Zerspanen = hoher Materialabtrag mit Schlagbelastung	250 - 600

Material groups			Application	Cutting speed m/min
Steel cast steel	Non-hardened, non-heat treated steels up to 1200 N/mm <sup>2</sup> (< 38 HRC)	Construction steels, carbon steels, tool steels, non-alloyed steels, case-hardened steels, cast steels	Coarse machining = high stock removal with impact load	250 - 600
	Hardened, heat treated steels exceeding 1200 N/mm <sup>2</sup> (> 38 HRC)	tool steels, tempering steels, alloyed steels, cast steels		250 - 350
Non-Ferrous metals	High-temperature resistant materials	Nickel based alloys cabalt based alloys (aircraft engine and turbine construction)	Coarse machining = high stock removal with impact load	250 - 450
Cast iron	Grey cast iron, white cast iron	Cast-iron with flake graphite EN-GJL (GG), with nodular graphite cast iron EN-GJS (GGG), white anneales cast iron EN-GJMW (GTW), black cast iron EN-GJMB (GTS)	Coarse machining = high stock removal with impact load	250 - 600



Schnittgeschwindigkeit • Cutting speed (m/min)				
	250	500	600	900
∅ (mm)	Drehzahlen (min <sup>-1</sup> ) • Rotational speed (rpm)			
6	13.000	27.000	32.000	48.000
8	10.000	20.000	24.000	36.000
10	8.000	16.000	19.000	29.000
12	7.000	13.000	16.000	24.000
16	5.000	10.000	12.000	18.000



11 5004



**A FORM / SHAPE ZYA**

Zylinder ohne Stirnverzahnung

Cylinder without end cut

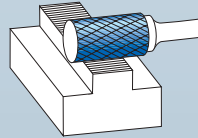

Schnittdaten  
Cutting data

Film  
Movie



Art.	d1	l2	d2	l1	gelötet brazed	VHM solid	€
11 5004 065	• 6	18	6	50		✓	12,65
11 5004 080	• 8	20	6	65	✓		15,85
11 5004 090	• 10	20	6	65	✓		18,85
11 5004 100	• 10	25	6	70	✓		21,00
11 5004 105	• 12	25	6	70	✓		28,05
11 5004 115	• 12	25	8	70	✓		29,40
11 5004 120	• 16	25	6	70	✓		34,05
11 5004 125	• 16	25	8	70	✓		19,45

Art.	d1	l2	d2	l1	gelötet brazed	VHM solid	€
11 3004 065	• 6	18	6	50		✓	10,60
11 3004 080	• 8	20	6	65	✓		13,80
11 3004 090	• 10	20	6	65	✓		15,50
11 3004 100	• 10	25	6	70	✓		17,65
11 3004 105	• 12	25	6	70	✓		23,15
11 3004 115	• 12	25	8	70	✓		24,50
11 3004 120	• 16	25	6	70	✓		29,15
11 3004 125	• 16	25	8	70	✓		16,90

11 5014



**B FORM / SHAPE ZYB**

Zylinder mit Stirnverzahnung

Cylinder with end cut

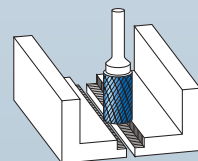

Schnittdaten  
Cutting data

Film  
Movie



Art.	d1	l2	d2	l1	gelötet brazed	VHM solid	€
11 5014 050	• 6	18	6	50		✓	13,60
11 5014 075	• 8	20	6	65	✓		17,25
11 5014 085	• 10	20	6	65	✓		19,70
11 5014 100	• 12	25	6	70	✓		30,35
11 5014 110	• 12	25	8	70	✓		16,85
11 5014 120	• 16	25	8	70	✓		39,50

Art.	d1	l2	d2	l1	gelötet brazed	VHM solid	€
11 3014 050	• 6	18	6	50		✓	11,50
11 3014 075	• 8	20	6	65	✓		15,20
11 3014 085	• 10	20	6	65	✓		16,35
11 3014 100	• 12	25	6	70	✓		25,45
11 3014 110	• 12	25	8	70	✓		26,85
11 3014 115	• 16	25	6	70	✓		32,00
11 3014 120	• 16	25	8	70	✓		18,45





11 5024



## C FORM / SHAPE WRC

Walzenrundform  
Ball nosed cylinder

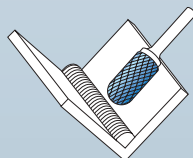

Schnittdaten  
Cutting data

Film  
Movie

[i](#)

[777](#)

[▶](#)

Art.	d1	l2	d2	l1	gelötet brazed	VHM solid	€
11 5024 055	• 6	18	6	50		✓	14,30
11 5024 075	• 8	20	6	65	✓		17,10
11 5024 085	• 10	20	6	65	✓		19,90
11 5024 105	• 12	25	6	70	✓		30,90
11 5024 115	• 12	25	8	70	✓		32,35
11 5024 120	• 16	25	6	70	✓		37,55
11 5024 125	• 16	25	8	70	✓		39,65

Art.	d1	l2	d2	l1	gelötet brazed	VHM solid	€
11 3024 055	• 6	18	6	50		✓	12,25
11 3024 075	• 8	20	6	65	✓		15,05
11 3024 085	• 10	20	6	65	✓		16,50
11 3024 105	• 12	25	6	70	✓		26,00
11 3024 115	• 12	25	8	70	✓		27,45
11 3024 120	• 16	25	6	70	✓		32,60
11 3024 125	• 16	25	8	70	✓		34,70

11 5034



## D FORM / SHAPE KUD

Kugel  
Ball

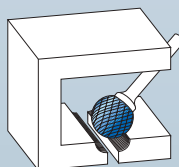

Schnittdaten  
Cutting data

Film  
Movie

[i](#)

[777](#)

[▶](#)

Art.	d1	l2	d2	l1	gelötet brazed	VHM solid	€
11 5034 055	• 6	4,7	6	50		✓	13,35
11 5034 060	• 8	6,0	6	52	✓		14,20
11 5034 070	• 10	8,0	6	54	✓		17,10
11 5034 080	• 12	11,0	6	56	✓		23,45
11 5034 085	% 12	11,0	8	56	✓		12,45
11 5034 095	• 16	14,0	6	60	✓		27,60
11 5034 100	% 16	14,0	8	60	✓		16,60

Art.	d1	l2	d2	l1	gelötet brazed	VHM solid	€
11 3034 055	• 6	4,7	6	50		✓	11,30
11 3034 060	• 8	6,0	6	52	✓		12,15
11 3034 070	• 10	8,0	6	54	✓		13,75
11 3034 080	• 12	11,0	6	56	✓		18,55
11 3034 085	• 12	11,0	8	56	✓		18,55
11 3034 095	• 16	14,0	6	60	✓		22,70
11 3034 100	% 16	14,0	8	60	✓		14,05

% Sonderpreis / Sale Artikel. Lieferbar solange Vorrat.  
Special price / sale article. While stocks last.



11 5044



**E** FORM / SHAPE **TRE**



Tropfen

Oval

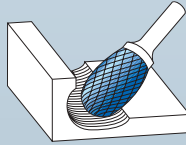

Schnittdaten  
Cutting data

Film  
Movie



Art.	d1	l2	d2	l1	gelötet brazed	VHM solid	€
11 5044 020	• 6	10	6	50		✓	15,85
11 5044 025	• 8	15	6	60	✓		18,00
11 5044 030	• 10	16	6	60	✓		19,90
11 5044 035	• 12	22	6	67	✓		29,10
11 5044 040	• 12	22	8	67	✓		30,40
11 5044 045	• 16	25	6	70	✓		38,55
11 5044 050	• 16	25	8	70	✓		40,60

Art.	d1	l2	d2	l1	gelötet brazed	VHM solid	€
11 3044 020	• 6	10	6	50		✓	13,80
11 3044 025	• 8	15	6	60	✓		15,95
11 3044 030	• 10	16	6	60	✓		16,50
11 3044 035	• 12	22	6	67	✓		24,20
11 3044 040	• 12	22	8	67	✓		13,60
11 3044 045	• 16	25	6	70	✓		33,65

11 5054



**F** FORM / SHAPE **RBF**



Rundbogen

Ball nosed tree

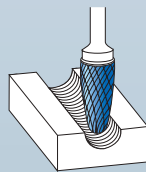

Schnittdaten  
Cutting data

Film  
Movie



Art.	d1	l2	d2	l1	gelötet brazed	VHM solid	€
11 5054 030	• 6	18	6	50		✓	14,90
11 5054 035	• 8	20	6	65	✓		19,15
11 5054 040	• 10	20	6	65	✓		19,50
11 5054 050	• 12	25	6	70	✓		29,75
11 5054 055	• 12	25	8	70	✓		29,75
11 5054 065	• 16	25	6	70	✓		39,40
11 5054 070	• 16	25	8	70	✓		39,40

Art.	d1	l2	d2	l1	gelötet brazed	VHM solid	€
11 3054 030	• 6	18	6	50		✓	12,85
11 3054 035	• 8	20	6	65	✓		17,10
11 3054 040	• 10	20	6	65	✓		16,15
11 3054 050	• 12	25	6	70	✓		24,85
11 3054 055	• 12	25	8	70	✓		24,85
11 3054 065	• 16	25	6	70	✓		34,45



11 5064



## G FORM / SHAPE SPG

Spitzbogen

Tree

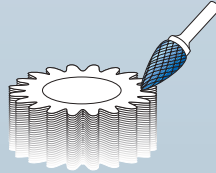

Schnittdaten  
Cutting data

777

Film  
Movie

Art.	d1	l2	d2	l1	gelötet brazed	VHM solid	€
11 5064 035	• 6	18	6	50		✓	14,90
11 5064 040	• 8	20	6	65	✓		17,65
11 5064 045	• 10	20	6	65	✓		20,60
11 5064 060	• 12	25	6	70	✓		29,35
11 5064 065	• 12	25	8	70	✓		29,35
11 5064 085	• 16	25	6	70	✓		37,45
11 5064 090	% 16	25	8	70	✓		21,70

Art.	d1	l2	d2	l1	gelötet brazed	VHM solid	€
11 3064 035	• 6	18	6	50		✓	12,85
11 3064 040	• 8	20	6	65	✓		15,55
11 3064 045	• 10	20	6	65	✓		17,25
11 3064 060	• 12	25	6	70	✓		24,40
11 3064 065	% 12	25	8	70	✓		13,00
11 3064 090	% 16	25	8	70	✓		18,70

11 5074



## H FORM / SHAPE

Flamme

Flame

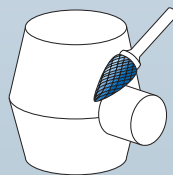

Schnittdaten  
Cutting data

777

Film  
Movie

Art.	d1	l2	d2	l1	gelötet brazed	VHM solid	€
11 5074 010	• 6	14	6	50		✓	18,35
11 5074 015	• 8	20	6	65	✓		19,70
11 5074 020	• 10	20	6	65	✓		33,45
11 5074 025	• 12	32	6	77	✓		39,40
11 5074 030	• 12	32	8	77	✓		39,40
11 5074 035	• 16	36	6	82	✓		52,65
11 5074 040	• 16	36	8	82	✓		55,20

Art.	d1	l2	d2	l1	gelötet brazed	VHM solid	€
11 3074 010	• 6	14	6	50		✓	16,25
11 3074 015	• 8	20	6	65	✓		17,65
11 3074 020	• 10	20	6	65	✓		30,10
11 3074 025	• 12	32	6	77	✓		34,45
11 3074 030	• 12	32	8	77	✓		34,45
11 3074 035	• 16	36	6	82	✓		47,75
11 3074 040	% 16	36	8	82	✓		26,75

% Sonderpreis / Sale Artikel. Lieferbar solange Vorrat.  
Special price / sale article. While stocks last.



11 5084



L FORM / SHAPE

KEL



Rundkegel

Ball nosed cone

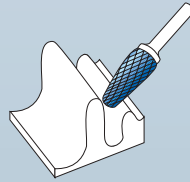

Schnittdaten  
Cutting data

Film  
Movie



Art.	d1	l2	d2	l1	gelötet brazed	VHM solid	α°	€
11 5084 020	• 6	18	6	50		✓	14°	15,15
11 5084 025	• 8	25	6	70	✓		14°	19,30
11 5084 035	• 10	30	6	75	✓		14°	24,00
11 5084 045	• 12	32	6	77	✓		14°	30,10
11 5084 050	• 12	32	8	77	✓		14°	30,10
11 5084 060	• 16	33	6	78	✓		14°	43,85
11 5084 065	% 16	33	8	78	✓		14°	23,30

Art.	d1	l2	d2	l1	gelötet brazed	VHM solid	α°	€
11 3084 020	• 6	18	6	50		✓	14°	13,10
11 3084 025	• 8	25	6	70	✓		14°	17,20
11 3084 035	• 10	30	6	75	✓		14°	20,65
11 3084 045	• 12	32	6	77	✓		14°	25,20
11 3084 050	• 12	32	8	77	✓		14°	25,20
11 3084 060	% 16	33	6	78	✓		14°	20,70
11 3084 065	• 16	33	8	78	✓		14°	38,90

11 5094



M FORM / SHAPE

SKM



Spitzkegel

Cone

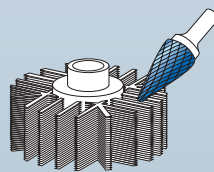

Schnittdaten  
Cutting data

Film  
Movie



Art.	d1	l2	d2	l1	gelötet brazed	VHM solid	α°	€
11 5094 030	• 6	20	6	50		✓	14°	15,15
11 5094 040	• 10	20	6	65	✓		13°	23,60
11 5094 045	• 12	25	6	70	✓		28°	29,35
11 5094 050	% 12	25	8	70	✓		28°	15,60
11 5094 055	• 16	26	6	74	✓		33°	39,50

Art.	d1	l2	d2	l1	gelötet brazed	VHM solid	α°	€
11 3094 030	• 6	20	6	50		✓	14°	13,10
11 3094 040	• 10	20	6	65	✓		13°	20,20
11 3094 045	• 12	25	6	70	✓		28°	24,40
11 3094 050	% 12	25	8	70	✓		28°	13,00
11 3094 055	% 16	26	6	74	✓		33°	18,40
11 3094 060	% 16	26	8	74	✓		33°	19,45

% Sonderpreis / Sale Artikel. Lieferbar solange Vorrat.  
Special price / sale article. While stocks last.





1



2



3



4



5



6



7



8



9



10













POWER.  
PRECISION.  
PERFORMANCE.

**Karnasch**®  
PROFESSIONAL TOOLS

# HP-7

Speziell für NE-Metalle wie Alu, Kupfer, Messing sowie alle Kunststoffe  
 Especially for non-ferrous materials such as Aluminum, copper, brass.  
 Also for all kinds of plastics.

## ANWENDUNG · APPLICATION











 Stahl Steel	 Gehärteter Stahl Hardened steel	 Edelstahl Stainless	 Gusseisen Cast iron	 Titan Titanium	 Cermet Cermet	 Nickel Nickel	 Kupfer, Kupferlegierungen Copper, copper alloys	 Alu Alu	 Kunststoffe GFK/CFK Plastics GRP/CRP
---	---	---	---	--	---	--	---	---	--

✓ OPTIMAL  
 ✓ GUT GOOD

- Alulegierungen
- Leichtmetalle
- Weiche Buntmetalle (NE-Metalle)
- Kunststoffe
- Faserverstärkte Kunststoffe GFK/CFK

- Aluminum alloy
- Light metals
- Soft copper and copper alloys (non-ferrous metals)
- Plastics
- Fibre-reinforced plastic (GFK/CFK)

## Lagerprogramm + Katalogseiten · Stockrange + catalogue pages

ZYA	ZYB	WRC	KUD	TRE	RBF	SPG	-	KEL	SKM	MINI-ALU
A	B	C	D	E	F	G	H	L	M	
Art. 11 5005 Art. 11 3005	Art. 11 5015 Art. 11 3015	Art. 11 5025 Art. 11 3025	Art. 11 5035 Art. 11 3035	Art. 11 5045 Art. 11 3045	Art. 11 5055 Art. 11 3055	Art. 11 5065 Art. 11 3065	Art. 11 5075 Art. 11 3075	Art. 11 5085 Art. 11 3085	Art. 11 5095 Art. 11 3095	
										
786	786	787	787	788	788	789	789	790	790	791
Zylinder Cylinder	Zylinder + Stirnverzahnung Cylinder + end cut	Walzenrundform Ball nosed cylinder	Kugel Ball	Tropfen Oval	Rundbogen Ball nosed tree	Spitzbogen Tree	Flamme Flame	Rundkegel Ball nosed cone	Spitzkegel Cone	Minifrässtifte in feiner Aluverzahnung Mini-burrs in Alu cutting style



BLACK-TEC-beschichtet  
 BLACK-TEC-coated

Karnasch BLACK-TEC-Beschichtung wurde speziell für NE-Metalle entwickelt (Verzahnung HP-7) hervorragende Reib- und Gleiteigenschaften verringern die Bildung von Aufbauschneiden.

Karnasch BLACK-TEC coating is specifically designed for non-ferrous metals (Cut HP-7). Low friction and excellent chip clearance characteristics reduce clogging of the flutes.

Werkstoffgruppen			Bearbeitung	Schnittgeschwindigkeit (m/min)
NE-Metalle	Weiche NE- Metalle	Alulegierungen, Messing, Kupfer, Zink	Grobes Zerspanen = Hoher Materialabtrag	600 - 1100
			Feines Zerspanen = Geringer Materialabtrag	900 - 1100
	Harte NE- Metalle	Bronze, Titan, harte Alulegierungen (hoher Si-Anteil)	Grobes Zerspanen = Hoher Materialabtrag	600 - 1100
			Feines Zerspanen = Geringer Materialabtrag	900 - 1100
Kunststoff, andere Werkstoffe	Faserverstärkte Kunststoffe (GFK/CFK) thermoplastische Kunststoffe, Hartgummi	Grobes Zerspanen = Hoher Materialabtrag	500 - 1100	
		Feines Zerspanen = Geringer Materialabtrag	500 - 1100	

Material groups			Application	Cutting speed m/min
Non-ferrous metals	Soft non-ferrous metals	Alu alloys, brass copper, zinc	Coarse machining = high stock removal	600 - 1100
			Fine machining = low stock removal	900 - 1100
	Hard non-ferrous metals	Bronze, titanium, hard aluminum alloys, (high Si content)	Coarse machining = high stock removal	600 - 1100
			Fine machining = low stock removal	900 - 1100
Plastics, other materials	Fibre-reinforced plastic (GFK/CFK) thermoplastics, hard rubber	Coarse machining = high stock removal	500 - 1100	
		Fine machining = low stock removal	500 - 1100	



Schnittgeschwindigkeit • Cutting speed (m/min)				
	500	600	900	1100
∅ (mm)	Drehzahlen (min <sup>-1</sup> ) • Rotational speed (rpm)			
2	80.000	95.000	143.000	175.000
3	53.000	64.000	95.000	116.000
4	40.000	48.000	72.000	88.000
6	27.000	32.000	48.000	59.000
8	20.000	24.000	36.000	44.000
10	16.000	19.000	29.000	35.000
12	13.000	16.000	24.000	30.000
16	10.000	12.000	18.000	22.000
20	8.000	10.000	14.000	17.000
25	6.000	8.000	11.000	13.500



- 1
- 2
- 3
- 4
- 5
- 6
- 7
- 8
- 9
- 10

11 5005



**A FORM / SHAPE ZYA**



Zylinder ohne Stirnverzahnung

Cylinder without end cut

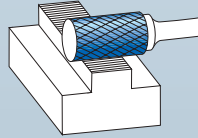

Schnittdaten  
Cutting data

Film  
Movie



Art.	d1	l2	d2	l1	gelötet brazed	VHM solid	€
11 5005 030	• 3	14	3	38		✓	12,55
11 5005 060	• 6	13	3	45	✓		21,05
11 5005 065	• 6	18	6	50		✓	17,85
11 5005 080	• 8	20	6	65	✓		22,20
11 5005 090	• 10	20	6	65	✓		26,00
11 5005 105	• 12	25	6	70	✓		36,95
11 5005 120	• 16	25	6	70	✓		43,05
11 5005 125	• 16	25	8	70	✓		24,20
11 5005 130	• 20	25	6	70	✓		62,00
11 5005 135	• 20	25	8	70	✓		34,00

Art.	d1	l2	d2	l1	gelötet brazed	VHM solid	€
11 3005 030	• 3	14	3	38		✓	9,00
11 3005 060	• 6	13	3	45	✓		16,25
11 3005 065	• 6	18	6	50		✓	13,00
11 3005 080	• 8	20	6	65	✓		17,35
11 3005 090	• 10	20	6	65	✓		19,50
11 3005 105	• 12	25	6	70	✓		29,00
11 3005 120	• 16	25	6	70	✓		35,10
11 3005 130	• 20	25	6	70	✓		48,20
11 3005 135	• 20	25	8	70	✓		26,90
11 3005 140	• 25	25	6	70	✓		90,80

11 5015



**B FORM / SHAPE ZYB**

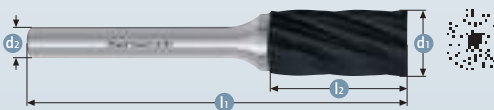

Zylinder mit Stirnverzahnung

Cylinder with end cut

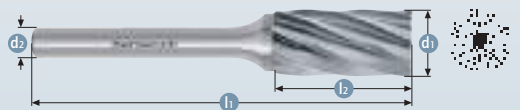
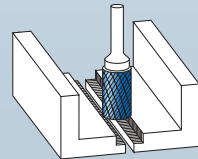

Schnittdaten  
Cutting data

Film  
Movie



Art.	d1	l2	d2	l1	gelötet brazed	VHM solid	€
11 5015 015	• 3	14	3	38		✓	13,55
11 5015 045	• 6	13	3	45	✓		23,60
11 5015 050	• 6	18	6	50		✓	19,25
11 5015 075	• 8	20	6	65	✓		23,90
11 5015 085	• 10	20	6	65	✓		28,00
11 5015 100	• 12	25	6	70	✓		39,40
11 5015 110	• 12	25	8	70	✓		41,75
11 5015 115	• 16	25	6	70	✓		46,50
11 5015 120	• 16	25	8	70	✓		49,20
11 5015 125	• 20	25	6	70	✓		66,80
11 5015 130	• 20	25	8	70	✓		36,60
11 5015 135	• 25	25	6	70	✓		117,75

Art.	d1	l2	d2	l1	gelötet brazed	VHM solid	€
11 3015 015	• 3	14	3	38		✓	10,00
11 3015 045	• 6	13	3	45	✓		18,75
11 3015 050	• 6	18	6	50		✓	14,40
11 3015 075	• 8	20	6	65	✓		19,05
11 3015 085	• 10	20	6	65	✓		21,50
11 3015 100	• 12	25	6	70	✓		31,45
11 3015 110	• 12	25	8	70	✓		33,80
11 3015 115	• 16	25	6	70	✓		38,55
11 3015 120	• 16	25	8	70	✓		41,25
11 3015 125	• 20	25	6	70	✓		53,00
11 3015 130	• 20	25	8	70	✓		29,50
11 3015 135	• 25	25	6	70	✓		103,95



11 5025



## C FORM / SHAPE WRC

Walzenrundform  
Ball nosed cylinder

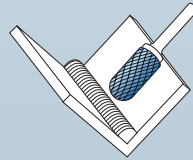

Schnittdaten  
Cutting data

Film  
Movie

785

Art.	d1	l2	d2	l1	gelötet brazed	VHM solid	€
11 5025 020	• 2	11	3	38		✓	12,55
11 5025 025	• 3	14	3	38		✓	12,55
11 5025 050	• 6	12,7	3	44	✓		21,70
11 5025 055	• 6	18	6	50		✓	19,40
11 5025 075	• 8	20	6	65	✓		27,10
11 5025 085	• 10	20	6	65	✓		26,00
11 5025 100	• 12	20	6	65	✓		41,35
11 5025 105	• 12	25	6	70	✓		36,55
11 5025 120	• 16	25	6	70	✓		55,20
11 5025 125	• 16	25	8	70	✓		55,20
11 5025 130	• 20	25	6	70	✓		73,30
11 5025 135	• 20	25	8	70	✓		38,75

Art.	d1	l2	d2	l1	gelötet brazed	VHM solid	€
11 3025 020	• 2	11	3	38		✓	9,00
11 3025 025	• 3	14	3	38		✓	9,00
11 3025 050	• 6	12,7	3	44	✓		16,90
11 3025 055	• 6	18	6	50		✓	14,55
11 3025 075	• 8	20	6	65	✓		22,30
11 3025 085	• 10	20	6	65	✓		19,50
11 3025 100	• 12	20	6	65	✓		33,40
11 3025 105	• 12	25	6	70	✓		28,60
11 3025 115	• 12	25	8	70	✓		31,45
11 3025 120	• 16	25	6	70	✓		47,25
11 3025 125	• 16	25	8	70	✓		25,15
11 3025 130	• 20	25	6	70	✓		59,45
11 3025 135	• 20	25	8	70	✓		31,65

11 5035



## D FORM / SHAPE KUD

Kugel  
Ball

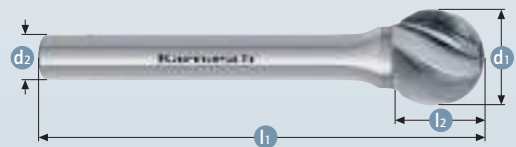
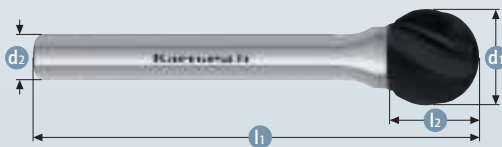
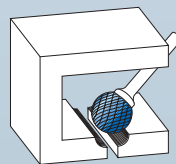

Schnittdaten  
Cutting data

Film  
Movie

785

Art.	d1	l2	d2	l1	gelötet brazed	VHM solid	€
11 5035 020	• 2	1,8	3	38		✓	12,55
11 5035 025	• 3	2,7	3	38		✓	12,55
11 5035 045	• 4	3,4	3	38		✓	28,10
11 5035 050	• 6	5,0	3	38	✓		19,10
11 5035 055	• 6	4,7	6	50		✓	19,25
11 5035 060	• 8	6,0	6	52	✓		24,55
11 5035 070	• 10	8,0	6	54	✓		22,60
11 5035 080	• 12	11,0	6	56	✓		36,55
11 5035 085	• 12	11,0	8	56	✓		38,15
11 5035 095	• 16	11,0	6	60	✓		45,15
11 5035 100	• 16	11,0	8	60	✓		23,90
11 5035 105	• 20	16,5	6	62	✓		62,15
11 5035 110	• 20	16,5	8	62	✓		62,15
11 5035 115	• 25	22,0	6	68	✓		90,90
11 5035 120	• 25	22,0	8	68	✓		90,90

Art.	d1	l2	d2	l1	gelötet brazed	VHM solid	€
11 3035 020	• 2	1,8	3	38		✓	9,00
11 3035 025	• 3	2,7	3	38		✓	9,00
11 3035 045	• 4	3,4	3	38		✓	23,90
11 3035 050	• 6	5,0	3	38	✓		14,30
11 3035 055	• 6	4,7	6	50		✓	14,40
11 3035 060	• 8	6,0	6	52	✓		19,75
11 3035 070	• 10	8,0	6	54	✓		16,10
11 3035 080	• 12	11,0	6	56	✓		28,60
11 3035 085	• 12	11,0	8	56	✓		30,20
11 3035 095	• 16	11,0	6	60	✓		37,20
11 3035 105	• 20	16,5	6	62	✓		48,35
11 3035 110	• 20	16,5	8	62	✓		25,75
11 3035 115	• 25	22,0	6	68	✓		77,10

• Sonderpreis / Sale Artikel. Lieferbar solange Vorrat.  
Special price / sale article. While stocks last.



- 1
- 2
- 3
- 4
- 5
- 6
- 7
- 8
- 9
- 10

11 5045



**E FORM / SHAPE TRE**

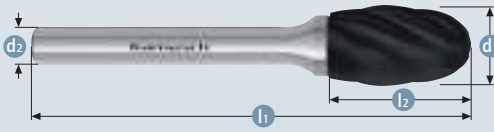

Tropfen

Oval

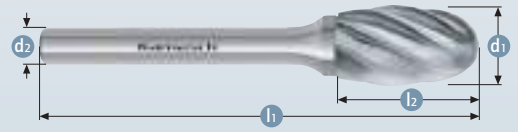
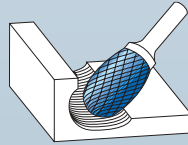

Schnittdaten  
Cutting data

Film  
Movie



Art.	d1	l2	d2	l1	gelötet brazed	VHM solid	€
11 5045 010	● 3	6	3	38		✓	12,55
11 5045 015	● 6	10	3	42	✓		21,90
11 5045 020	● 6	10	6	50		✓	26,50
11 5045 025	● 8	15	6	60	✓		24,60
11 5045 030	● 10	16	6	60	✓		27,25
11 5045 035	● 12	22	6	67	✓		34,05
11 5045 045	● 16	25	6	70	✓		50,45
11 5045 050	● 16	25	8	70	✓		26,70
11 5045 055	● 20	25	6	70	✓		70,80
11 5045 060	● 20	25	8	70	✓		37,45

Art.	d1	l2	d2	l1	gelötet brazed	VHM solid	€
11 3045 010	● 3	6	3	38		✓	9,00
11 3045 015	● 6	10	3	42	✓		17,05
11 3045 020	● 6	10	6	50		✓	21,70
11 3045 025	● 8	15	6	60	✓		19,80
11 3045 030	● 10	16	6	60	✓		20,80
11 3045 035	● 12	22	6	67	✓		26,10
11 3045 045	● 16	25	6	70	✓		42,50
11 3045 050	● 16	25	8	70	✓		22,60
11 3045 055	● 20	25	6	70	✓		57,00
11 3045 060	● 20	25	8	70	✓		30,35

11 5055



**F FORM / SHAPE RBF**



Rundbogen

Ball nosed tree

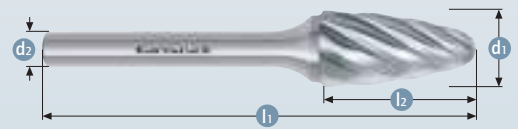
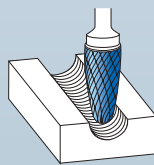

Schnittdaten  
Cutting data

Film  
Movie



Art.	d1	l2	d2	l1	gelötet brazed	VHM solid	€
11 5055 015	● 3	14	3	38		✓	12,55
11 5055 025	● 6	12	3	44	✓		21,90
11 5055 030	● 6	18	6	50		✓	19,40
11 5055 035	● 8	20	6	65	✓		25,90
11 5055 040	● 10	20	6	65	✓		27,15
11 5055 050	● 12	25	6	70	✓		38,35
11 5055 055	● 12	25	8	70	✓		38,35
11 5055 065	● 16	25	6	70	✓		45,15
11 5055 070	● 16	25	8	70	✓		45,15
11 5055 075	● 20	25	6	70	✓		67,60
11 5055 080	● 20	25	8	70	✓		35,75

Art.	d1	l2	d2	l1	gelötet brazed	VHM solid	€
11 3055 015	● 3	14	3	38		✓	9,00
11 3055 025	● 6	12	3	44	✓		17,05
11 3055 030	● 6	18	6	50		✓	14,55
11 3055 035	● 8	20	6	65	✓		21,10
11 3055 040	● 10	20	6	65	✓		20,65
11 3055 050	● 12	25	6	70	✓		30,40
11 3055 055	● 12	25	8	70	✓		30,40
11 3055 065	● 16	25	6	70	✓		37,20
11 3055 070	● 16	25	8	70	✓		37,20
11 3055 075	● 20	25	6	70	✓		53,80
11 3055 080	● 20	25	8	70	✓		28,65

11 5065



## G FORM / SHAPE SPG

Spitzbogen

Tree

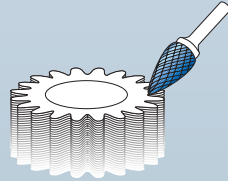

Schnittdaten Cutting data	Film Movie
785	

Art.	d1	l2	d2	l1	gelötet brazed	VHM solid	€
11 5065 015	• 3	14	3	38		✓	12,55
11 5065 030	• 6	12	3	44	✓		21,90
11 5065 035	• 6	18	6	50		✓	24,95
11 5065 040	• 8	20	6	65	✓		25,15
11 5065 045	• 10	20	6	65	✓		29,05
11 5065 060	• 12	25	6	70	✓		38,20
11 5065 085	• 16	25	6	70	✓		54,75

Art.	d1	l2	d2	l1	gelötet brazed	VHM solid	€
11 3065 015	• 3	14	3	38		✓	9,00
11 3065 030	• 6	12	3	44	✓		17,05
11 3065 035	• 6	18	6	50		✓	20,10
11 3065 040	• 8	20	6	65	✓		20,35
11 3065 045	• 10	20	6	65	✓		22,55
11 3065 060	• 12	25	6	70	✓		30,25
11 3065 085	• 16	25	6	70	✓		46,80

11 5075



## H FORM / SHAPE

Flamme

Flame

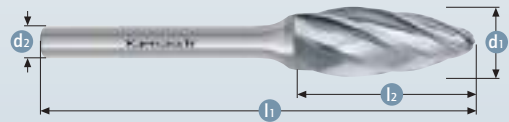
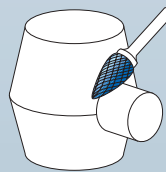
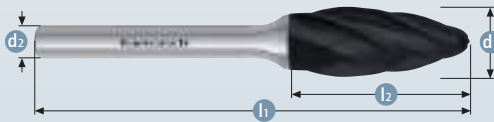

Schnittdaten Cutting data	Film Movie
785	

Art.	d1	l2	d2	l1	gelötet brazed	VHM solid	€
11 5075 015	• 8	20	6	65	✓		26,75
11 5075 020	• 10	20	6	65	✓		46,65
11 5075 025	• 12	32	6	77	✓		50,55
11 5075 035	• 16	36	6	82	✓		76,60

Art.	d1	l2	d2	l1	gelötet brazed	VHM solid	€
11 3075 015	• 8	20	6	65	✓		21,95
11 3075 020	• 10	20	6	65	✓		40,15
11 3075 025	• 12	32	6	77	✓		42,60
11 3075 035	• 16	36	6	82	✓		68,65



- 1
- 2
- 3
- 4
- 5
- 6
- 7
- 8
- 9
- 10

11 5085



L FORM / SHAPE

KEL

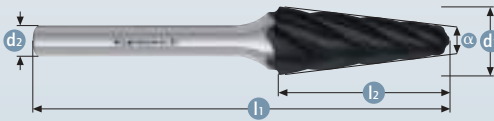

Rundkegel

Ball nosed cone

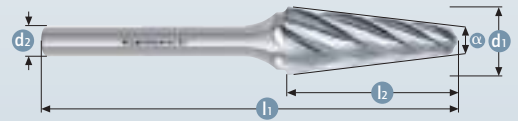
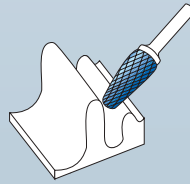

Schnittdaten  
Cutting data

Film  
Movie



Art.	d1	l2	d2	l1	gelötet brazed	VHM solid	α°	€
11 5085 010	• 3	14	3	38		✓	8°	12,55
11 5085 015	• 6	16	3	48	✓		22°	21,90
11 5085 020	• 6	18	6	50		✓	14°	26,20
11 5085 025	• 8	25	6	70	✓		14°	27,30
11 5085 035	• 10	30	6	75	✓		14°	33,00
11 5085 045	• 12	32	6	77	✓		14°	41,10
11 5085 050	• 12	32	8	77	✓		14°	41,10
11 5085 055	• 12	32	6	182	✓		14°	33,10
11 5085 060	• 16	33	6	78	✓		14°	55,20
11 5085 065	• 16	33	8	78	✓		14°	55,20

Art.	d1	l2	d2	l1	gelötet brazed	VHM solid	α°	€
11 3085 010	• 3	14	3	38		✓	8°	9,00
11 3085 015	• 6	16	3	48	✓		22°	17,05
11 3085 020	• 6	18	6	50		✓	14°	21,35
11 3085 025	• 8	25	6	70	✓		14°	22,50
11 3085 035	• 10	30	6	75	✓		14°	26,50
11 3085 045	• 12	32	6	77	✓		14°	33,15
11 3085 050	• 12	32	8	77	✓		14°	33,15
11 3085 055	• 12	32	6	182	✓		14°	49,15
11 3085 060	• 16	33	6	78	✓		14°	47,25

11 5095



M FORM / SHAPE

SKM

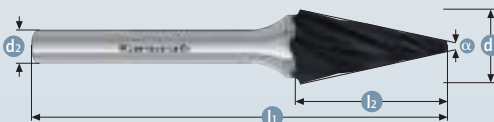

Spitzkegel

Cone

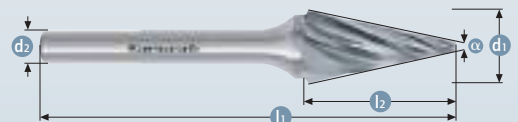
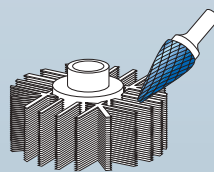

Schnittdaten  
Cutting data

Film  
Movie



Art.	d1	l2	d2	l1	gelötet brazed	VHM solid	α°	€
11 5095 015	• 3	11	3	38		✓	8°	12,55
11 5095 025	• 6	12	3	44	✓		22°	21,05
11 5095 030	• 6	20	6	50		✓	14°	24,15
11 5095 040	• 10	20	6	65	✓		14°	30,40
11 5095 045	• 12	25	6	70	✓		14°	36,75

Art.	d1	l2	d2	l1	gelötet brazed	VHM solid	α°	€
11 3095 015	• 3	11	3	38		✓	8°	9,00
11 3095 025	• 6	12	3	44	✓		22°	16,25
11 3095 030	• 6	20	6	50		✓	14°	19,30
11 3095 040	• 10	20	6	65	✓		14°	23,90
11 3095 045	• 12	25	6	70	✓		14°	28,80

Einsatzgebiete:  
Zu bearbeitende Werkstoffe:  
Drehzahlempfehlung:

Feinmechanik, Werkzeugbau  
Alulegierungen, Leichtmetalle, Buntmetalle, Kunststoffe  
ca. 70.000 U/min

Applications:  
For use on:  
Recommended operating speed:

Precision engineering, tool manufacture  
Aluminum alloys, light metals, copper and copper alloys, plastics  
approx. 70,000 RPM

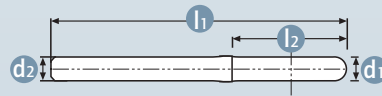
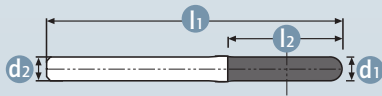

Art.	d1	l2	d2	l1	Form Shape	DIN 8033	€
11 5005 030	• 3	14	3	38	A	ZYA	12,55
11 5015 015	• 3	14	3	38	B	ZYB	13,55
11 5025 020	• 2	11	3	38	C	WRC	12,55
11 5025 025	• 3	14	3	38	C	WRC	12,55
11 5035 020	• 2	1,75	3	38	D	KUD	12,55
11 5035 025	• 3	2,7	3	38	D	KUD	12,55
11 5045 010	• 3	6	3	38	E	TRE	12,55
11 5055 015	• 3	14	3	38	F	RBF	12,55
11 5065 015	• 3	14	3	38	G	SPG	12,55
11 5085 010	• 3	14	3	38	L	KEL	12,55
11 5095 015	• 3	11	3	38	M	SKM	12,55

Art.	d1	l2	d2	l1	Form Shape	DIN 8033	€
11 3005 030	• 3	14	3	38	A	ZYA	9,00
11 3015 015	• 3	14	3	38	B	ZYB	10,00
11 3025 020	• 2	11	3	38	C	WRC	9,00
11 3025 025	• 3	14	3	38	C	WRC	9,00
11 3035 020	• 2	1,75	3	38	D	KUD	9,00
11 3035 025	• 3	2,7	3	38	D	KUD	9,00
11 3045 010	• 3	6	3	38	E	TRE	9,00
11 3055 015	• 3	14	3	38	F	RBF	9,00
11 3065 015	• 3	14	3	38	G	SPG	9,00
11 3085 010	• 3	14	3	38	L	KEL	9,00
11 3095 015	• 3	11	3	38	M	SKM	9,00



# HP-1

Für Superlegierungen. Extrem robuste Kreuzverzählung  
 For super alloys. Extremely robust cross cutting style

## ANWENDUNG · APPLICATION

Stahl Steel	Gehärteter Stahl Hardened steel	Edelstahl Stainless	Gusseisen Cast iron	Titan Titanium	Cermet Cermet	Nickel Nickel	Kupfer, Kupferlegierungen Copper, copper alloys	Alu Alu	Kunststoffe GFK/CFK Plastics GRP/CRP
✓	✓	✓		✓		✓			

✓ OPTIMAL  
 OPTIMAL  
 ✓ GUT  
 GOOD

- Schlagunempfindlichkeit (Zahnausbrüche, Ablatzungen, Kopfbrüche werden minimiert)
  - Exzellente Kontrolle und Laufruhe
  - Mittlere bis hohe Zerspanleistung
  - Speziell für schwierigste Superlegierungen + Edelstähle wie: Titan, Inconel, Hastelloy, Waspaloy, Duplex, Amanox usw.
- Anwendungsbeispiel: Bearbeitung von Flugzeug Turbinenschaufeln, Gasturbinen

- Impact resistance (tooth breakages, chipping, head breakages are minimised)
  - Excellent control and quiet running
  - Medium to high cutting action
  - Especially for the most difficult super alloys + stainless steel, such as: Titanium, Inconel, Hastelloy, Waspaloy, Duplex, Amanox, etc.
- Application example: Working aeroplane turbine blades, gas turbines

## Lagerprogramm + Katalogseiten • Stockrange + catalogue pages

ZYA	ZYB	WRC	KUD	TRE	RBF	SPG	-	KEL	SKM	Ø 3 mm
A	B	C	D	E	F	G	H	L	M	
Art. 11 5007 Art. 11 3007	Art. 11 5017 Art. 11 3017	Art. 11 5027 Art. 11 3027	Art. 11 5037 Art. 11 3037	Art. 11 5047 Art. 11 3047	Art. 11 5057 Art. 11 3057	Art. 11 5067 Art. 11 3067	Art. 11 5077 Art. 11 3077	Art. 11 5087 Art. 11 3087	Art. 11 5097 Art. 11 3097	
794	794	795	795	796	796	797	797	798	798	799
Zylinder Cylinder	Zylinder + Stirnverzählung Cylinder + end cut	Walzenrundform Ball nosed cylinder	Kugel Ball	Tropfen Oval	Rundbogen Ball nosed tree	Spitzbogen Tree	Flamme Flame	Rundkegel Ball nosed cone	Spitzkegel Cone	Ø 3 mm, Schaft 3 mm, für Superlegierungen! Ø 3 mm, shank 3 mm, for super alloys!



BLUE-TEC-beschichtet  
 BLUE-TEC-coated

Die für Frässtifte optimierte und patentierte BLUE-TEC-Beschichtung ergibt einzigartige Standzeiten und Performance in allen Stahlsorten.

Patented BLUE-TEC coating, specifically designed for burrs, gives outstanding tool life and excellent performance on all metals.

Werkstoffgruppen			Bearbeitung	Schnittgeschwindigkeit (m/min)
Schwierigste Legierungen Superlegierungen	Titan, Inconel, Hastelloy, Waspaloy, Duplex, Amanox Udimet, Nicrofer, Conicro, René	Motoren-, Turbinen- und Triebwerksbau Energietechnik, Luft- und Raumfahrt Öl- und Gasindustrie, Gasturbinen	grobes Zerspanen = hoher bis mittlerer Materialabtrag	250-350
Edelstahl (INOX)	Rost- und säurebeständige Stähle	Austenitische und ferritische Edelstähle	grobes Zerspanen = hoher bis mittlerer Materialabtrag	250-350
Stahl, Stahlguss	Ungehärtet, nicht vergütete Stähle bis 1200 N/mm <sup>2</sup> (<38 HRC)	Baustähle, Kohlenstoffstähle, Werkzeugstähle, unlegierte Stähle, Einsatzstähle, Stahlguss	grobes Zerspanen = hoher bis mittlerer Materialabtrag	450-600
	Gehärtete, vergütete Stähle über 1200 N/mm <sup>2</sup> (>38 HRC)	Werkzeugstähle, Vergütungsstähle, legierte Stähle, Stahlguss		250-350
Gusseisen	Graues Gusseisen, weißes Gusseisen	Gusseisen mit Lamellengraphit EN-GJL (GG), mit Kugelgraphit/ Sphäroguss EN-GJS (GGG), weißer Temperguss EN-GJMW (GTW), schwarzer Temperguss EN-GJMB (GTS)	grobes Zerspanen = hoher bis mittlerer Materialabtrag	450-600

Material groups			Application	Cutting speed m/min
difficult alloys superalloys	Titan, Inconel, Hastelloy, Waspaloy, Duplex, Amanox Udimet, Nicrofer, Conicro, René	Engines, aircraft engine and turbine construction, energy technology, aerospace oil and gas industry, gas turbines	Coarse machining = high to medium stock removal	250-350
Stainless steel (INOX)	Rust and acid-resistant steels	Austenitic and ferritic stainless steels	Coarse machining = high to medium stock removal	250-350
Steel cast steel	Non-hardened, non-heat treated steels up to 1200 N/mm <sup>2</sup> (<38 HRC)	Construction steels, carbon steels, tool steels, non-alloyed steels, case-hardened steels, cast steels	Coarse machining = high to medium stock removal	450-600
	Hardened, heat treated steels exceeding 1200 N/mm <sup>2</sup> (>38 HRC)	tool steels, tempering steels, alloyed steels, cast steels		250-350
Cast iron	Grey cast iron, white cast iron	Cast-iron with flake graphite EN-GJL (GG), with nodular graphite cast iron EN-GJS (GGG), white annealed cast iron EN-GJMW (GTW), black cast iron EN-GJMB (GTS)	Coarse machining = high to medium stock removal	450-600



Schnittgeschwindigkeit • Cutting speed (m/min)							
	250	300	350	400	450	500	600
∅ (mm)	Drehzahlen (min <sup>-1</sup> ) • Rotational speed (rpm)						
3	27.000	32.000	37.000	42.000	48.000	53.000	64.000
6	13.000	16.000	19.000	21.000	24.000	27.000	32.000
8	10.000	12.000	14.000	16.000	18.000	20.000	24.000
10	8.000	10.000	11.000	13.000	14.000	16.000	19.000
12	7.000	8.000	9.000	11.000	12.000	13.000	16.000
16	5.000	6.000	7.000	8.000	9.000	10.000	12.000



- 1
- 2
- 3
- 4
- 5
- 6
- 7
- 8
- 9
- 10

11 5007



11 3007

**A FORM / SHAPE ZYA**

Zylinder ohne Stirnverzahnung

Cylinder without end cut

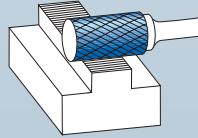

Schnittdaten  
Cutting data

Film  
Movie



Art.	d1	l2	d2	l1	gelötet brazed	VHM solid	€
11 5007 030	• 3	14	3	38		✓	9,65
11 5007 060	• 6	13	3	45	✓		11,65
11 5007 065	• 6	18	6	50		✓	15,50
11 5007 080	• 8	20	6	65	✓		15,50
11 5007 090	• 10	20	6	65	✓		17,85
11 5007 100	• 10	25	6	70	✓		20,60
11 5007 107	• 12DIN	25	6	70	✓		25,50
11 5007 120	• 16	25	6	70	✓		33,25

Art.	d1	l2	d2	l1	gelötet brazed	VHM solid	€
11 3007 030	• 3	14	3	38		✓	7,55
11 3007 060	• 6	13	3	45	✓		9,60
11 3007 065	• 6	18	6	50		✓	13,45
11 3007 080	• 8	20	6	65	✓		13,45
11 3007 090	• 10	20	6	65	✓		14,50
11 3007 100	• 10	25	6	70	✓		17,25
11 3007 107	• 12DIN	25	6	70	✓		20,60
11 3007 120	• 16	25	6	70	✓		28,35

11 5017



11 3017

**B FORM / SHAPE ZYB**

Zylinder mit Stirnverzahnung

Cylinder with end cut

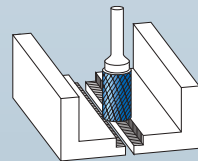

Schnittdaten  
Cutting data

Film  
Movie



Art.	d1	l2	d2	l1	gelötet brazed	VHM solid	€
11 5017 015	• 3	14	3	38		✓	10,40
11 5017 045	• 6	13	3	45	✓		12,50
11 5017 050	• 6	18	6	50		✓	13,25
11 5017 075	• 8	20	6	65	✓		16,80
11 5017 085	• 10	20	6	65	✓		19,25
11 5017 103	• 12DIN	25	6	70	✓		27,75
11 5017 115	• 16	25	6	70	✓		36,10

Art.	d1	l2	d2	l1	gelötet brazed	VHM solid	€
11 3017 015	• 3	14	3	38		✓	8,35
11 3017 045	• 6	13	3	45	✓		10,45
11 3017 050	• 6	18	6	50		✓	11,20
11 3017 075	• 8	20	6	65	✓		14,75
11 3017 085	• 10	20	6	65	✓		15,90
11 3017 103	• 12DIN	25	6	70	✓		22,80
11 3017 115	• 16	25	6	70	✓		31,20



11 5027



## C FORM / SHAPE WRC

Walzenrundform  
Ball nosed cylinder

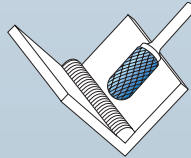

Schnittdaten Cutting data	Film Movie
793	

Art.	d1	l2	d2	l1	gelötet brazed	VHM solid	€
11 5027 025	• 3	14	3	38		✓	9,65
11 5027 050	• 6	12,7	3	44	✓	✓	11,65
11 5027 055	• 6	18	6	50		✓	13,95
11 5027 075	• 8	20	6	65	✓		16,70
11 5027 085	• 10	20	6	65	✓		19,50
11 5027 107	• 12DIN	25	6	70	✓		28,25
11 5027 120	• 16	25	6	70	✓		36,75

Art.	d1	l2	d2	l1	gelötet brazed	VHM solid	€
11 3027 025	• 3	14	3	38		✓	7,55
11 3027 050	• 6	12,7	3	44	✓	✓	9,60
11 3027 055	• 6	18	6	50		✓	11,90
11 3027 075	• 8	20	6	65	✓		14,60
11 3027 085	• 10	20	6	65	✓		16,15
11 3027 107	• 12DIN	25	6	70	✓		23,35
11 3027 120	• 16	25	6	70	✓		16,95

11 5037



## D FORM / SHAPE KUD

Kugel  
Ball

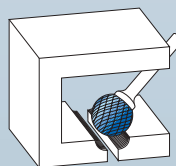

Schnittdaten Cutting data	Film Movie
793	

Art.	d1	l2	d2	l1	gelötet brazed	VHM solid	€
11 5037 025	• 3	2,5	3	38		✓	9,65
11 5037 050	• 6	5,0	3	38	✓	✓	11,65
11 5037 055	• 6	5,4	6	50		✓	13,05
11 5037 060	• 8	6,0	6	52	✓		13,85
11 5037 070	• 10	8,0	6	54	✓		16,55
11 5037 083	• 12DIN	11,0	6	56	✓		20,75
11 5037 095	• 16	14,0	6	60	✓		26,90

Art.	d1	l2	d2	l1	gelötet brazed	VHM solid	€
11 3037 025	• 3	2,5	3	38		✓	7,55
11 3037 050	• 6	5,0	3	38	✓	✓	9,60
11 3037 055	• 6	5,4	6	50		✓	11,00
11 3037 060	• 8	6,0	6	52	✓		11,80
11 3037 070	• 10	8,0	6	54	✓		13,20
11 3037 083	• 12DIN	11,0	6	56	✓		15,80

⊘ Sonderpreis / Sale Artikel. Lieferbar solange Vorrat.  
Special price / sale article. While stocks last.



11 5047



E FORM / SHAPE TRE



Tropfen

Oval

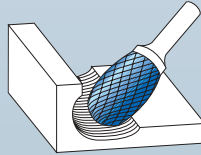

Schnittdaten  
Cutting data

Film  
Movie



Art.	d1	l2	d2	l1	gelötet brazed	VHM solid	€
11 5047 010	• 3	6	3	38		✓	9,65
11 5047 015	• 6	10	3	42	✓		11,65
11 5047 020	• 6	10	6	50		✓	15,50
11 5047 025	• 8	15	6	60	✓		18,35
11 5047 030	• 10	16	6	60	✓		19,50
11 5047 037	• 12DIN	21	6	66	✓		26,50
11 5047 045	• 16	25	6	70	✓		37,60

Art.	d1	l2	d2	l1	gelötet brazed	VHM solid	€
11 3047 010	• 3	6	3	38		✓	7,55
11 3047 015	• 6	10	3	42	✓		9,60
11 3047 020	• 6	10	6	50		✓	13,45
11 3047 025	• 8	15	6	60	✓		16,25
11 3047 030	• 10	16	6	60	✓		16,15
11 3047 037	• 12DIN	21	6	66	✓		21,60
11 3047 045	• 16	25	6	70	✓		17,40

11 5057



F FORM / SHAPE RBF



Rundbogen

Ball nosed tree

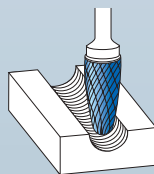

Schnittdaten  
Cutting data

Film  
Movie



Art.	d1	l2	d2	l1	gelötet brazed	VHM solid	€
11 5057 015	• 3	14	3	38		✓	9,65
11 5057 025	• 6	12	3	44	✓		11,65
11 5057 030	• 6	18	6	50		✓	14,55
11 5057 035	• 8	20	6	65	✓		19,45
11 5057 040	• 10	20	6	65	✓		19,00
11 5057 053	• 12DIN	25	6	70	✓		24,60
11 5057 065	• 16	25	6	70	✓		37,05

Art.	d1	l2	d2	l1	gelötet brazed	VHM solid	€
11 3057 015	• 3	14	3	38		✓	7,55
11 3057 025	• 6	12	3	44	✓		9,60
11 3057 030	• 6	18	6	50		✓	12,50
11 3057 035	• 8	20	6	65	✓		17,35
11 3057 040	• 10	20	6	65	✓		15,65
11 3057 053	• 12DIN	25	6	70	✓		19,70
11 3057 065	• 16	25	6	70	✓		17,10



11 5067



## G FORM / SHAPE SPG

Spitzbogen

Tree

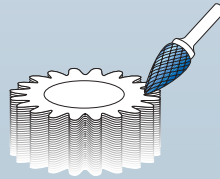

Schnittdaten Cutting data	Film Movie
793	

Art.	d1	l2	d2	l1	gelötet brazed	VHM solid	€
11 5067 015	• 3	14	3	38		✓	9,65
11 5067 030	• 6	12	3	44	✓		11,65
11 5067 035	• 6	18	6	50		✓	14,55
11 5067 040	• 8	20	6	65	✓		17,20
11 5067 045	• 10	20	6	65	✓		20,10
11 5067 063	• 12DIN	25	6	70	✓		25,75
11 5067 085	• 16	25	6	70	✓		36,65

Art.	d1	l2	d2	l1	gelötet brazed	VHM solid	€
11 3067 015	• 3	14	3	38		✓	7,55
11 3067 030	• 6	12	3	44	✓		9,60
11 3067 035	• 6	18	6	50		✓	12,50
11 3067 040	• 8	20	6	65	✓		15,15
11 3067 045	• 10	20	6	65	✓		16,70
11 3067 063	• 12DIN	25	6	70	✓		20,85
11 3067 085	• 16	25	6	70	✓		16,90

11 5077



## H FORM / SHAPE

Flamme

Flame

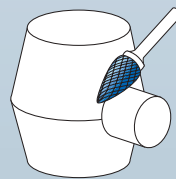

Schnittdaten Cutting data	Film Movie
793	

Art.	d1	l2	d2	l1	gelötet brazed	VHM solid	€
11 5077 005	• 3	6	3	38		✓	9,65
11 5077 009	• 6	10	3	43		✓	11,65
11 5077 010	• 6	14	6	50		✓	18,60
11 5077 015	• 8	20	6	65	✓		18,55
11 5077 020	• 10	20	6	65	✓		34,05
11 5077 027	• 12DIN	30	6	75	✓		38,00
11 5077 035	• 16	36	6	82	✓		51,40

Art.	d1	l2	d2	l1	gelötet brazed	VHM solid	€
11 3077 005	• 3	6	3	38		✓	7,55
11 3077 009	• 6	10	3	43		✓	9,60
11 3077 010	• 6	14	6	50		✓	9,00
11 3077 015	• 8	20	6	65	✓		16,50
11 3077 020	• 10	20	6	65	✓		30,70
11 3077 027	• 12DIN	30	6	75	✓		33,10

⊘ Sonderpreis / Sale Artikel. Lieferbar solange Vorrat.  
Special price / sale article. While stocks last.



11 5087



L FORM / SHAPE KEL



Rundkegel  
Ball nosed cone

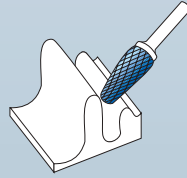

Schnittdaten  
Cutting data

Film  
Movie



Art.	d1	l2	d2	l1	gelötet brazed	VHM solid	α°	€
11 5087 010	• 3	14	3	38		✓	8°	9,65
11 5087 015	• 6	16	3	48	✓		22°	11,65
11 5087 020	• 6	18	6	50		✓	14°	14,85
11 5087 025	• 8	25	6	70	✓		14°	18,75
11 5087 030	• 10	20	6	65	✓		14°	23,45
11 5087 047	• 12DIN	25	6	70	✓		14°	28,65
11 5087 060	% 16	33	6	78	✓		14°	23,65

% Sonderpreis / Sale Artikel. Lieferbar solange Vorrat.  
Special price / sale article. While stocks last.

Art.	d1	l2	d2	l1	gelötet brazed	VHM solid	α°	€
11 3087 010	• 3	14	3	38		✓	8°	7,55
11 3087 015	• 6	16	3	48	✓		22°	9,60
11 3087 020	• 6	18	6	50		✓	14°	12,75
11 3087 025	• 8	25	6	70	✓		14°	16,65
11 3087 030	• 10	20	6	65	✓		14°	20,10
11 3087 047	• 12DIN	25	6	70	✓		14°	23,75
11 3087 060	% 16	33	6	78	✓		14°	21,10

% Sonderpreis / Sale Artikel. Lieferbar solange Vorrat.  
Special price / sale article. While stocks last.

11 5097



M FORM / SHAPE SKM



Spitzkegel  
Cone

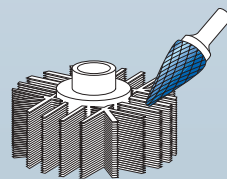

Schnittdaten  
Cutting data

Film  
Movie



Art.	d1	l2	d2	l1	gelötet brazed	VHM solid	α°	€
11 5097 015	• 3	11	3	38		✓	14°	9,65
11 5097 025	• 6	12	3	48	✓		22°	11,65
11 5097 030	• 6	20	6	50		✓	14°	14,85
11 5097 040	• 10	20	6	65	✓		28°	24,00
11 5097 047	• 12DIN	25	6	70	✓		28°	27,85
11 5097 055	• 16	26	6	74	✓		33°	38,55

Art.	d1	l2	d2	l1	gelötet brazed	VHM solid	α°	€
11 3097 015	• 3	11	3	38		✓	14°	7,55
11 3097 025	• 6	12	3	48	✓		22°	9,60
11 3097 030	• 6	20	6	50		✓	14°	12,75
11 3097 040	• 10	20	6	65	✓		28°	20,65
11 3097 047	• 12DIN	25	6	70	✓		28°	22,95
11 3097 055	% 16	26	6	74	✓		33°	17,90

% Sonderpreis / Sale Artikel. Lieferbar solange Vorrat.  
Special price / sale article. While stocks last.



Speziell optimierte HP-1 Verzahnung für Rotierfräser 3 mm  
Specially optimized HP-1 cut for burrs 3 mm



Art.	d1	l2	d2	l1	Form Shape	DIN 8033		€
11 5007 030	● 3	14	3	38	<b>A</b>	ZYA		9,65
11 5017 015	● 3	14	3	38	<b>B</b>	ZYB		10,40
11 5027 025	● 3	14	3	38	<b>C</b>	WRC		9,65
11 5037 025	● 3	2,7	3	38	<b>D</b>	KUD		9,65
11 5047 010	● 3	6,0	3	38	<b>E</b>	TRE		9,65
11 5057 015	● 3	14	3	38	<b>F</b>	RBF		9,65
11 5067 015	● 3	14	3	38	<b>G</b>	SPG		9,65
11 5077 005	● 3	6	3	38	<b>H</b>	-		9,65
11 5087 010	● 3	14	3	38	<b>L</b>	KEL		9,65
11 5097 015	● 3	15	3	38	<b>M</b>	SKM		9,65

Art.	d1	l2	d2	l1	Form Shape	DIN 8033		€
11 3007 030	● 3	14	3	38	<b>A</b>	ZYA		7,55
11 3017 015	● 3	14	3	38	<b>B</b>	ZYB		8,35
11 3027 025	● 3	14	3	38	<b>C</b>	WRC		7,55
11 3037 025	● 3	2,7	3	38	<b>D</b>	KUD		7,55
11 3047 010	● 3	6,0	3	38	<b>E</b>	TRE		7,55
11 3057 015	● 3	14	3	38	<b>F</b>	RBF		7,55
11 3067 015	● 3	14	3	38	<b>G</b>	SPG		7,55
11 3077 005	● 3	6	3	38	<b>H</b>	-		7,55
11 3087 010	● 3	14	3	38	<b>L</b>	KEL		7,55
11 3097 015	● 3	15	3	38	<b>M</b>	SKM		7,55

1



2



3



4



5



6



7



8



9







10

Index

# HP-8

Speziell für Stahl und Stahlguss. Extrem hohe Zerspanleistung  
 Especially for steel and cast steel. Extremely high machining output

## ANWENDUNG · APPLICATION

									
Stahl Steel	Gehärteter Stahl Hardened steel	Edelstahl Stainless	Gusseisen Cast iron	Titan Titanium	Cermet Cermet	Nickel Nickel	Kupfer, Kupferlegierungen Copper, copper alloys	Alu Alu	Kunststoffe GFK/CFK Plastics GRP/CRP
<input checked="" type="checkbox"/>	<input checked="" type="checkbox"/>		<input checked="" type="checkbox"/>						

OPTIMAL  
 GOOD

- Bis zu 60% höhere Zerspanleistung im Vergleich zu herkömmlichen Kreuzverzahnungen.
- Hohe Aggressivität erzeugt große Späne mit hervorragender Spanabfuhr.
- Keine Anlauffarben am Werkstück durch geringe Wärmeentwicklung

- Up to 60% higher machining output as compared to conventional cross cut.
- High aggressiveness produces large chips with outstanding chip removal.
- No annealing colours at the workpiece due to low heat development.

### Lagerprogramm + Katalogseiten • Stockrange + catalogue pages

ZYA	ZYB	WRC	KUD	TRE	RBF	SPG	-	KEL	SKM
A	B	C	D	E	F	G	H	L	M
Art. 11 6041 Art. 11 4041	Art. 11 6042 Art. 11 4042	Art. 11 6043 Art. 11 4043	Art. 11 6044 Art. 11 4044	Art. 11 6045 Art. 11 4045	Art. 11 6046 Art. 11 4046	Art. 11 6047 Art. 11 4047	Art. 11 6048 Art. 11 4048	Art. 11 6049 Art. 11 4049	Art. 11 6050 Art. 11 4050
									
802	802	803	803	804	804	805	805	806	806
Zylinder Cylinder	Zylinder + Stirnverzahnung Cylinder + end cut	Walzenrundform Ball nosed cylinder	Kugel Ball	Tropfen Oval	Rundbogen Ball nosed tree	Spitzbogen Tree	Flamme Flame	Rundkegel Ball nosed cone	Spitzkegel Cone



BLUE-TEC-beschichtet  
 BLUE-TEC-coated

Die für Frässtifte optimierte und patentierte BLUE-TEC-Beschichtung ergibt einzigartige Standzeiten und Performance in allen Stahlsorten.

Patented BLUE-TEC coating, specifically designed for burrs, gives outstanding tool life and excellent performance on all metals.

Werkstoffgruppen			Bearbeitung	Schnittgeschwindigkeit (m/min)
Stahl, Stahlguss	Ungehärtete, nicht vergütete Stähle bis 1200 N/mm <sup>2</sup> (< 38 HRC)	Baustähle, Kohlenstoffstähle, Werkzeugstähle, unlegierte Stähle, Einsatzstähle, Stahlguss	Grobes Zerspanen = hoher Materialabtrag mit Schlagbelastung	450 - 750
	Gehärtete, vergütete Stähle über 1200 N/mm <sup>2</sup> (> 38 HRC)	Werkzeugstähle, Vergütungsstähle, legierte Stähle, Stahlguss		

Material groups			Application	Cutting speed m/min
Steel cast steel	Non-hardened, non-heat treated steels up to 1200 N/mm <sup>2</sup> (< 38 HRC)	Construction steels, carbon steels, tool steels, non-alloyed steels, case-hardened steels, cast steels	Coarse machining = high stock removal with impact load	450 - 750
	Hardened, heat treated steels exceeding 1200 N/mm <sup>2</sup> (> 38 HRC)	tool steels, tempering steels, alloyed steels, cast steels		



Schnittgeschwindigkeit • Cutting speed (m/min)		
	450	750
∅ (mm)	Drehzahlen (min <sup>-1</sup> ) • Rotational speed (rpm)	
3	48.000	80.000
6	24.000	40.000
8	18.000	30.000
10	14.000	24.000
12	12.000	20.000
16	9.000	17.000



- 1
- 2
- 3
- 4
- 5
- 6
- 7
- 8
- 9
- 10

11 6041



**A FORM / SHAPE ZYA**

Zylinder ohne Stirnverzahnung

Cylinder without end cut

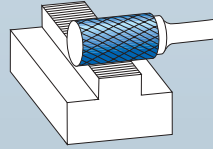

Schnittdaten  
Cutting data

Film  
Movie



Art.	d1	l2	d2	l1	gelötet brazed	VHM solid	€
11 6041 010	• 6	18	6	50		✓	12,70
11 6041 015	• 8	20	6	65	✓		15,90
11 6041 020	• 10	20	6	65	✓		18,25
11 6041 025	• 12	25	6	70	✓		28,05
11 6041 030	○ 16	25	6	70	✓		-

Art.	d1	l2	d2	l1	gelötet brazed	VHM solid	€
11 4041 010	• 6	18	6	50		✓	10,60
11 4041 015	• 8	20	6	65	✓		13,85
11 4041 020	• 10	20	6	65	✓		14,85
11 4041 025	• 12	25	6	70	✓		23,15
11 4041 030	○ 16	25	6	70	✓		-

11 6042



**B FORM / SHAPE ZYB**

Zylinder mit Stirnverzahnung

Cylinder with end cut

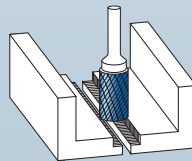

Schnittdaten  
Cutting data

Film  
Movie



Art.	d1	l2	d2	l1	gelötet brazed	VHM solid	€
11 6042 010	• 6	18	6	50		✓	13,55
11 6042 015	• 8	20	6	65	✓		17,25
11 6042 020	• 10	20	6	65	✓		19,70
11 6042 025	• 12	25	6	70	✓		30,35
11 6042 030	○ 16	25	6	70	✓		-

Art.	d1	l2	d2	l1	gelötet brazed	VHM solid	€
11 4042 010	• 6	18	6	50		✓	11,50
11 4042 015	• 8	20	6	65	✓		15,20
11 4042 020	• 10	20	6	65	✓		16,35
11 4042 025	• 12	25	6	70	✓		25,45
11 4042 030	○ 16	25	6	70	✓		-



11 6043



**C** FORM / SHAPE **WRC**

Walzenrundform  
Ball nosed cylinder

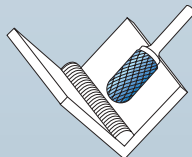

Schnittdaten  
Cutting data

Film  
Movie

801

Art.	d1	l2	d2	l1	gelötet brazed	VHM solid	€
11 6043 010	• 6	18	6	50		✓	14,35
11 6043 015	• 8	20	6	65	✓		17,10
11 6043 020	• 10	20	6	65	✓		19,90
11 6043 025	• 12	25	6	70	✓		30,90
11 6043 030	○ 16	25	6	70	✓		-

Art.	d1	l2	d2	l1	gelötet brazed	VHM solid	€
11 4043 010	• 6	18	6	50		✓	12,25
11 4043 015	• 8	20	6	65	✓		15,05
11 4043 020	• 10	20	6	65	✓		16,50
11 4043 025	• 12	25	6	70	✓		26,00
11 4043 030	○ 16	25	6	70	✓		-

11 6044



**D** FORM / SHAPE **KUD**

Kugel  
Ball

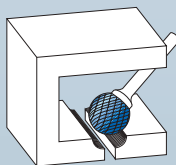

Schnittdaten  
Cutting data

Film  
Movie

801

Art.	d1	l2	d2	l1	gelötet brazed	VHM solid	€
11 6044 010	• 6	4,7	6	50		✓	13,30
11 6044 015	• 8	6,0	6	52	✓		14,15
11 6044 020	• 10	8,0	6	54	✓		16,95
11 6044 025	• 12	11,0	6	56	✓		23,15
11 6044 030	○ 16	11,0	6	60	✓		-

Art.	d1	l2	d2	l1	gelötet brazed	VHM solid	€
11 4044 010	• 6	4,7	6	50		✓	11,25
11 4044 015	• 8	6,0	6	52	✓		12,05
11 4044 020	• 10	8,0	6	54	✓		13,60
11 4044 025	• 12	11,0	6	56	✓		18,25
11 4044 030	○ 16	11,0	6	60	✓		-



- 1
- 2
- 3
- 4
- 5
- 6
- 7
- 8
- 9
- 10

11 6045



11 4045

**E** FORM / SHAPE **TRE**



Tropfen

Oval

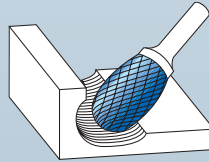

Schnittdaten  
Cutting data

Film  
Movie



Art.	d1	l2	d2	l1	gelötet brazed	VHM solid	€
11 6045 015	○ 8	15	6	60	✓		-
11 6045 020	○ 10	16	6	60	✓		-
11 6045 025	● 12	22	6	67	✓		29,10
11 6045 030	○ 16	25	6	70	✓		-

Art.	d1	l2	d2	l1	gelötet brazed	VHM solid	€
11 4045 015	○ 8	15	6	60	✓		-
11 4045 020	○ 10	16	6	60	✓		-
11 4045 025	● 12	22	6	67	✓		13,15
11 4045 030	○ 16	25	6	70	✓		-

11 6046



11 4046

**F** FORM / SHAPE **RBF**



Rundbogen

Ball nosed tree

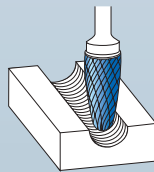

Schnittdaten  
Cutting data

Film  
Movie



Art.	d1	l2	d2	l1	gelötet brazed	VHM solid	€
11 6046 010	● 6	18	6	50		✓	14,90
11 6046 015	● 8	20	6	65	✓		19,90
11 6046 020	● 10	20	6	65	✓		19,45
11 6046 025	● 12	25	6	70	✓		27,15
11 6046 030	○ 16	25	6	70	✓		-

Art.	d1	l2	d2	l1	gelötet brazed	VHM solid	€
11 4046 010	● 6	18	6	50		✓	12,85
11 4046 015	● 8	20	6	65	✓		17,85
11 4046 020	● 10	20	6	65	✓		16,10
11 4046 025	● 12	25	6	70	✓		22,25
11 4046 030	○ 16	25	6	70	✓		-

11 6047



**G** FORM / SHAPE **SPG**

Spitzbogen

Tree

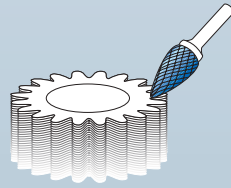

Schnittdaten Cutting data	Film Movie
801	

Art.	d1	l2	d2	l1	gelötet brazed	VHM solid	€
11 6047 010	● 6	18	6	50		✓	14,90
11 6047 015	● 8	20	6	65	✓		17,65
11 6047 020	● 10	20	6	65	✓		20,55
11 6047 025	● 12	25	6	70	✓		28,35
11 6047 030	○ 16	25	6	70	✓		-

Art.	d1	l2	d2	l1	gelötet brazed	VHM solid	€
11 4047 010	● 6	18	6	50		✓	12,85
11 4047 015	● 8	20	6	65	✓		15,55
11 4047 020	● 10	20	6	65	✓		17,20
11 4047 025	● 12	25	6	70	✓		23,45
11 4047 030	○ 16	25	6	70	✓		-

11 6048



**H** FORM / SHAPE

Flamme

Flame

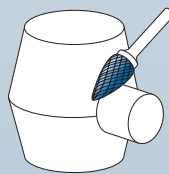

Schnittdaten Cutting data	Film Movie
801	

Art.	d1	l2	d2	l1	gelötet brazed	VHM solid	€
11 6048 015	● 8	20	6	65	✓		19,05
11 6048 020	○ 10	20	6	65	✓		-
11 6048 025	● 12	32	6	77	✓		40,95
11 6048 030	○ 16	36	6	82	✓		-

Art.	d1	l2	d2	l1	gelötet brazed	VHM solid	€
11 4048 015	● 8	20	6	65	✓		17,00
11 4048 020	○ 10	20	6	65	✓		-
11 4048 025	● 12	32	6	77	✓		36,05
11 4048 030	○ 16	36	6	82	✓		-



- 1
- 2
- 3
- 4
- 5
- 6
- 7
- 8
- 9
- 10

11 6049



L FORM / SHAPE KEL



11 4049



Rundkegel

Ball nosed cone

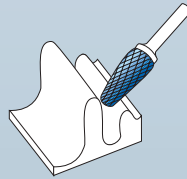

Schnittdaten  
Cutting data

Film  
Movie



Art.	d1	l2	d2	l1	gelötet brazed	VHM solid	α°	€
11 6049 015	○ 8	25	6	70	✓		14°	-
11 6049 017	● 10	20	6	65	✓		14°	26,20
11 6049 020	● 10	30	6	75	✓		14°	26,15
11 6049 025	● 12	32	6	77	✓		14°	31,25
11 6049 030	○ 16	33	6	78	✓		14°	-

Art.	d1	l2	d2	l1	gelötet brazed	VHM solid	α°	€
11 4049 015	○ 8	25	6	70	✓		14°	-
11 4049 017	● 10	20	6	65	✓		14°	22,80
11 4049 020	● 10	30	6	75	✓		14°	24,10
11 4049 025	● 12	32	6	77	✓		14°	26,35
11 4049 030	○ 16	33	6	78	✓		14°	-

11 6050



M FORM / SHAPE SKM



11 4050



Spitzkegel

Cone

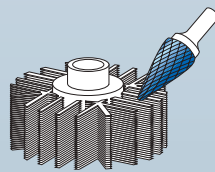

Schnittdaten  
Cutting data

Film  
Movie



Art.	d1	l2	d2	l1	gelötet brazed	VHM solid	α°	€
11 6050 020	○ 10	20	6	65	✓		14°	-
11 6050 025	○ 12	25	6	70	✓		14°	-

Art.	d1	l2	d2	l1	gelötet brazed	VHM solid	α°	€
11 4050 020	○ 10	20	6	65	✓		14°	-
11 4050 025	○ 12	25	6	70	✓		14°	-

Qualitätsprodukte für die Metallbearbeitung.  
Quality products for metalworking.



**BIS ZU  
400% STEIGERUNG  
DER STANDZEITEN DURCH  
HIGH-TECH BESCHICHTUNGEN**  
Up to 400% increase in tool life  
through high-tech coatings

- 1 
- 2 
- 3 
- 4 
- 5 
- 6 
- 7 
- 8 
- 9 
- 10 



**DAS KARNASCH PRODUKTSORTIMENT ONLINE!** Nutzen Sie unseren Onlineshop und profitieren Sie von den speziellen Vorteilen für Onlineshop-Kunden.

**THE KARNASCH PRODUCT RANGE ONLINE!** Use our online shop and benefit from the special advantages for online shop customers.

 [www.shop.karnasch.tools](http://www.shop.karnasch.tools)

# HP-9

Speziell für Edelstahl. Extrem hohe Zerspanleistung

Especially for stainless steel. Extremely high machining output.

## ANWENDUNG · APPLICATION







 Stahl Steel	 Gehärteter Stahl Hardened steel	 Edelstahl Stainless	 Gusseisen Cast iron	 Titan Titanium	 Cermet Cermet	 Nickel Nickel	 Kupfer, Kupferlegierungen Copper, copper alloys	 Alu Alu	 Kunststoffe GFK/CFK Plastics GRP/CRP
---	---	---	---	--	---	--	---	---	--

✓ OPTIMAL  
OPTIMAL  
✓ GUT  
GOOD

- Extrem hohe Zerspanleistung und Standzeit für alle austenitischen, rost- und säurebeständigen Stähle.
- Nickelbasis und Titanlegierungen (Drehzahl reduzieren um Funkenbildung zu vermeiden)
- Hochwertige Oberflächengüte
- Keine Anlauffarben am Werkstück durch geringe Wärmeentwicklung

- Extremely high machining output and service life for all austenitic, rust- and acid-resilient steels.
- Nickel basis and titanium alloy (reduce speed to avoid sparking)
- High-quality surface.
- No annealing colours at the workpiece due to low heat development.

## Lagerprogramm + Katalogseiten • Stockrange + catalogue pages

ZYA	ZYB	WRC	KUD	TRE	RBF	SPG	-	KEL	SKM
A	B	C	D	E	F	G	H	L	M
Art. 11 6031 Art. 11 4031	Art. 11 6032 Art. 11 4032	Art. 11 6033 Art. 11 4033	Art. 11 6034 Art. 11 4034	Art. 11 6035 Art. 11 4035	Art. 11 6036 Art. 11 4036	Art. 11 6037 Art. 11 4037	Art. 11 6038 Art. 11 4038	Art. 11 6039 Art. 11 4039	Art. 11 6040 Art. 11 4040
									
810	810	811	811	812	812	813	813	814	814
Zylinder Cylinder	Zylinder + Stirn- verzähnung Cylinder + end cut	Walzenrund- form Ball nosed cylinder	Kugel Ball	Tropfen Oval	Rundbogen Ball nosed tree	Spitzbogen Tree	Flamme Flame	Rundkegel Ball nosed cone	Spitzkegel Cone



Die für Frässtifte optimierte und patentierte BLUE-TEC-Beschichtung ergibt einzigartige Standzeiten und Performance in allen Stahlsorten.

Patented BLUE-TEC coating, specifically designed for burrs, gives outstanding tool life and excellent performance on all metals.

Werkstoffgruppen			Bearbeitung	Schnittgeschwindigkeit (m/min)
Edelstahl (INOX)	Rost- und säurebeständige Stähle	Austenitische und ferritische Edelstähle	Grobes Zerspanen = Hoher Materialabtrag	450 - 600
			Feines Zerspanen = Geringer Materialabtrag	

Material groups			Application	Cutting speed m/min
Stainless steel INOX	Rust and acid-resistant steels	Austenitic and ferritic stainless steels	Coarse machining = high stock removal	450 - 600
			Fine machining = low stock removal	



Schnittgeschwindigkeit • Cutting speed (m/min)		
	450	600
∅ (mm)	Drehzahlen (min <sup>-1</sup> ) • Rotational speed (rpm)	
3	48.000	64.000
6	24.000	32.000
8	18.000	24.000
10	14.000	19.000
12	12.000	16.000
16	9.000	12.000



11 6031



**A FORM / SHAPE ZYA**

Zylinder ohne Stirnverzahnung

Cylinder without end cut

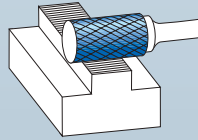

Schnittdaten  
Cutting data

Film  
Movie



Art.	d1	l2	d2	l1	gelötet brazed	VHM solid	€
11 6031 005	• 3	14	3	38		✓	11,20
11 6031 007	• 6,3	12,7	3	45		✓	18,45
11 6031 010	• 6	18	6	50		✓	13,65
11 6031 015	• 8	20	6	65	✓		17,15
11 6031 020	• 10	20	6	65	✓		19,55
11 6031 025	• 12	25	6	70	✓		30,10
11 6031 030	○ 16	25	6	70	✓		-

Art.	d1	l2	d2	l1	gelötet brazed	VHM solid	€
11 4031 005	• 3	14	3	38		✓	9,15
11 4031 007	• 6,3	12,7	3	45		✓	16,40
11 4031 010	• 6	18	6	50		✓	11,55
11 4031 015	• 8	20	6	65	✓		15,05
11 4031 020	• 10	20	6	65	✓		16,20
11 4031 025	• 12	25	6	70	✓		25,15
11 4031 030	○ 16	25	6	70	✓		-

11 6032



**B FORM / SHAPE ZYB**

Zylinder mit Stirnverzahnung

Cylinder with end cut

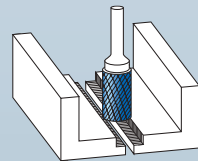

Schnittdaten  
Cutting data

Film  
Movie



Art.	d1	l2	d2	l1	gelötet brazed	VHM solid	€
11 6032 015	○ 8	20	6	65	✓		-
11 6032 020	○ 10	20	6	65	✓		-
11 6032 025	○ 12	25	6	70	✓		-
11 6032 030	○ 16	25	6	70	✓		-

Art.	d1	l2	d2	l1	gelötet brazed	VHM solid	€
11 4032 015	○ 8	20	6	65	✓		-
11 4032 020	○ 10	20	6	65	✓		-
11 4032 025	○ 12	25	6	70	✓		-
11 4032 030	○ 16	25	6	70	✓		-





11 6033



## C FORM / SHAPE WRC

Walzenrundform  
Ball nosed cylinder

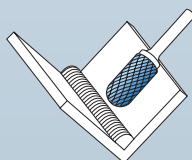

Schnittdaten Cutting data	Film Movie
809	

Art.	d1	l2	d2	l1	gelötet brazed	VHM solid	€
11 6033 005	• 3	14	3	38		✓	11,20
11 6033 007	• 6,3	12,7	3	45		✓	16,95
11 6033 010	• 6	18	6	50		✓	15,45
11 6033 015	• 8	20	6	65	✓		18,45
11 6033 020	• 10	20	6	65	✓		21,40
11 6033 025	• 12	25	6	70	✓		33,25
11 6033 030	○ 16	25	6	70	✓		-

Art.	d1	l2	d2	l1	gelötet brazed	VHM solid	€
11 4033 005	• 3	14	3	38		✓	9,15
11 4033 007	• 6,3	12,7	3	45		✓	14,90
11 4033 010	• 6	18	6	50		✓	13,40
11 4033 015	• 8	20	6	65	✓		16,40
11 4033 020	• 10	20	6	65	✓		18,05
11 4033 025	• 12	25	6	70	✓		28,35
11 4033 030	○ 16	25	6	70	✓		-

11 6034



## D FORM / SHAPE KUD

Kugel  
Ball

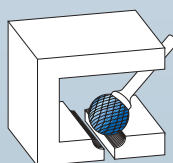

Schnittdaten Cutting data	Film Movie
809	

Art.	d1	l2	d2	l1	gelötet brazed	VHM solid	€
11 6034 005	• 3	2,5	3	38		✓	11,20
11 6034 007	• 6,3	5,0	3	38		✓	16,40
11 6034 010	• 6	4,7	6	50		✓	14,35
11 6034 015	• 8	6,0	6	52	✓		15,25
11 6034 020	• 10	8,0	6	54	✓		18,15
11 6034 025	• 12	11,0	6	56	✓		24,85
11 6034 030	○ 16	11,0	6	60	✓		-

Art.	d1	l2	d2	l1	gelötet brazed	VHM solid	€
11 4034 005	• 3	2,5	3	38		✓	9,15
11 4034 007	• 6,3	5,0	3	38		✓	14,35
11 4034 010	• 6	4,7	6	50	⊗	✓	6,65
11 4034 015	• 8	6,0	6	52	✓		13,15
11 4034 020	• 10	8,0	6	54	✓		14,80
11 4034 025	• 12	11,0	6	56	✓		19,95
11 4034 030	○ 16	11,0	6	60	✓		-

⊗ Sonderpreis / Sale Artikel. Lieferbar solange Vorrat.  
Special price / sale article. While stocks last.



11 6035



E FORM / SHAPE TRE



Tropfen

Oval

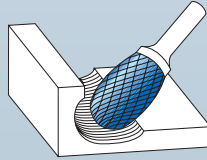

Schnittdaten  
Cutting data

Film  
Movie



Art.	d1	l2	d2	l1	gelötet brazed	VHM solid	€
11 6035 015	● 8	15	6	60	✓		20,30
11 6035 020	● 10	16	6	60	✓		21,40
11 6035 025	● 12	22	6	67	✓		31,30
11 6035 030	○ 16	25	6	70	✓		-

Art.	d1	l2	d2	l1	gelötet brazed	VHM solid	€
11 4035 015	● 8	15	6	60	✓		18,25
11 4035 020	● 10	16	6	60	✓		18,05
11 4035 025	● 12	22	6	67	✓		26,40
11 4035 030	○ 16	25	6	70	✓		-

11 6036



F FORM / SHAPE RBF



Rundbogen

Ball nosed tree

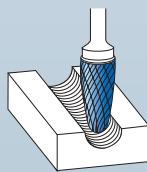

Schnittdaten  
Cutting data

Film  
Movie



Art.	d1	l2	d2	l1	gelötet brazed	VHM solid	€
11 6036 005	● 3	14	3	38		✓	11,20
11 6036 007	● 6,3	12,7	3	45		✓	16,95
11 6036 010	● 6	18	6	50		✓	16,10
11 6036 015	● 8	20	6	65	✓		21,55
11 6036 020	● 10	20	6	65	✓		20,90
11 6036 025	● 12	25	6	70	✓		29,15
11 6036 030	○ 16	25	6	70	✓		-

Art.	d1	l2	d2	l1	gelötet brazed	VHM solid	€
11 4036 005	● 3	14	3	38		✓	9,15
11 4036 007	● 6,3	12,7	3	45		✓	8,10
11 4036 010	● 6	18	6	50		✓	14,05
11 4036 015	● 8	20	6	65	✓		19,50
11 4036 020	● 10	20	6	65	✓		17,55
11 4036 025	● 12	25	6	70	✓		24,25
11 4036 030	○ 16	25	6	70	✓		-

- 1
- 2
- 3
- 4
- 5
- 6
- 7
- 8
- 9
- 10

11 6037



## G FORM / SHAPE SPG

Spitzbogen

Tree

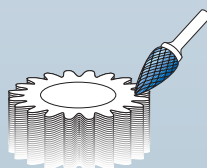

Schnittdaten Cutting data	Film Movie
809	

Art.	d1	l2	d2	l1	gelötet brazed	VHM solid	€
11 6037 010	• 6	18	6	50		✓	16,05
11 6037 015	• 8	20	6	65	✓		19,05
11 6037 020	• 10	20	6	65	✓		22,10
11 6037 025	• 12	25	6	70	✓		30,55
11 6037 030	○ 16	25	6	70	✓		-

Art.	d1	l2	d2	l1	gelötet brazed	VHM solid	€
11 4037 010	• 6	18	6	50		✓	14,00
11 4037 015	• 8	20	6	65	✓		16,95
11 4037 020	• 10	20	6	65	✓		18,75
11 4037 025	• 12	25	6	70	✓		25,65
11 4037 030	○ 16	25	6	70	✓		-

11 6038



## H FORM / SHAPE

Flamme

Flame

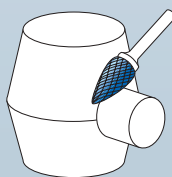

Schnittdaten Cutting data	Film Movie
809	

Art.	d1	l2	d2	l1	gelötet brazed	VHM solid	€
11 6038 015	• 8	20	6	65	✓		20,60
11 6038 020	• 10	20	6	65	✓		37,70
11 6038 025	• 12	32	6	77	✓		44,30
11 6038 030	○ 16	36	6	82	✓		-

Art.	d1	l2	d2	l1	gelötet brazed	VHM solid	€
11 4038 015	• 8	20	6	65	✓		18,50
11 4038 020	• 10	20	6	65	✓		34,35
11 4038 025	• 12	32	6	77	✓		39,35
11 4038 030	○ 16	36	6	82	✓		-



11 6039



L FORM / SHAPE KEL



11 4039



Rundkegel

Ball nosed cone

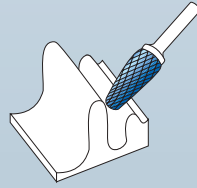

Schnittdaten  
Cutting data

Film  
Movie



Art.	d1	l2	d2	l1	gelötet brazed	VHM solid	α°	€
11 6039 015	• 8	25	6	70	✓		14°	20,75
11 6039 020	• 10	30	6	65	✓		14°	28,25
11 6039 025	• 12	32	6	77	✓		14°	33,65
11 6039 030	○ 16	33	6	78	✓		14°	-

Art.	d1	l2	d2	l1	gelötet brazed	VHM solid	α°	€
11 4039 015	• 8	25	6	70	✓		14°	18,70
11 4039 020	• 10	30	6	65	✓		14°	24,90
11 4039 025	• 12	32	6	77	✓		14°	28,75
11 4039 030	○ 16	33	6	78	✓		14°	-

11 6040



M FORM / SHAPE SKM



11 4040



Spitzkegel

Cone

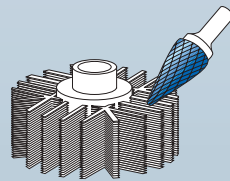

Schnittdaten  
Cutting data

Film  
Movie



Art.	d1	l2	d2	l1	gelötet brazed	VHM solid	α°	€
11 6040 020	○ 10	20	6	65	✓		14°	-
11 6040 025	○ 12	25	6	70	✓		14°	-

Art.	d1	l2	d2	l1	gelötet brazed	VHM solid	α°	€
11 4040 020	○ 10	20	6	65	✓		14°	-
11 4040 025	○ 12	25	6	70	✓		14°	-



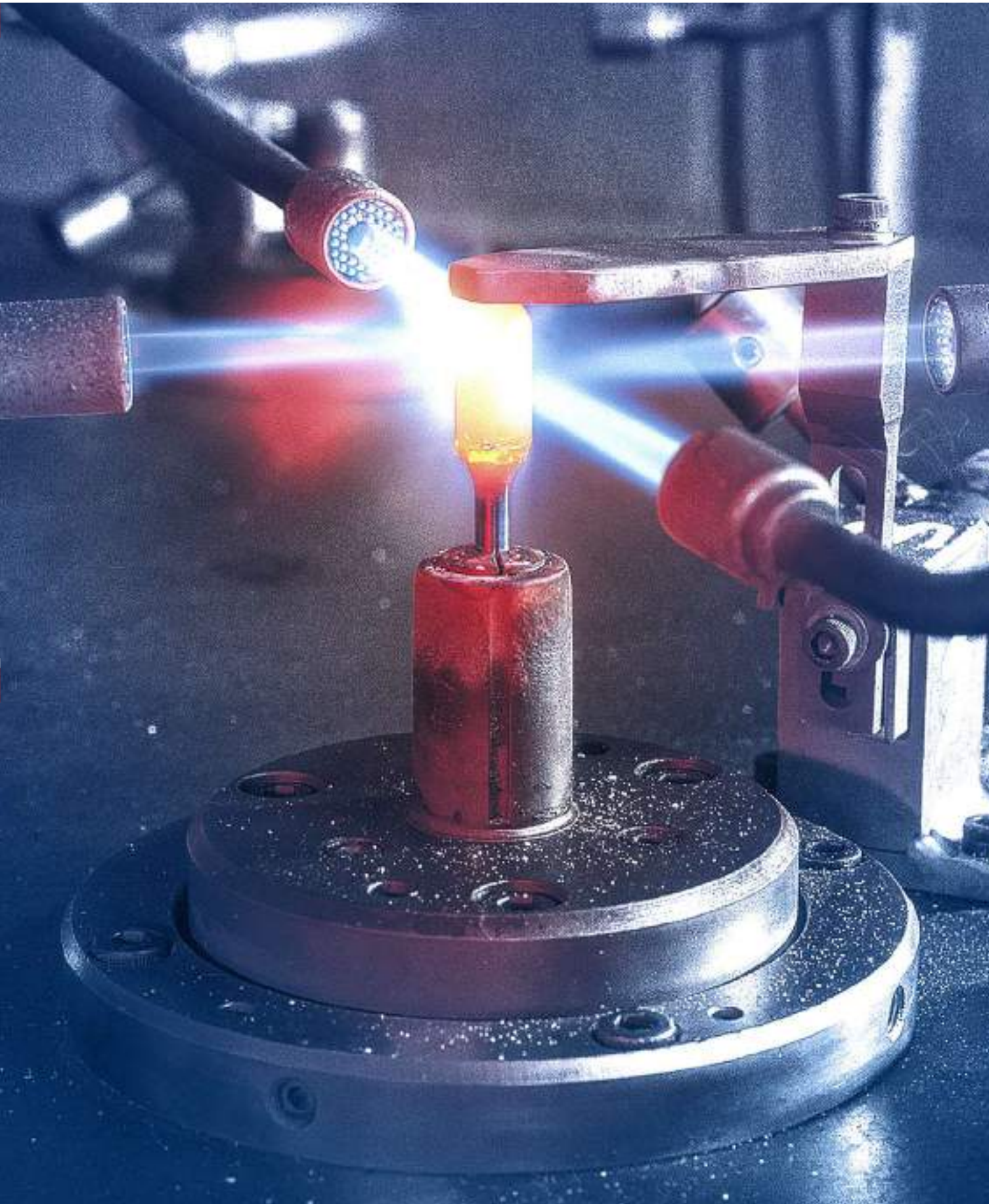

- 1 
- 2 
- 3 
- 4 
- 5 
- 6 
- 7 
- 8 
- 9 
- 10 

POWER.  
PRECISION.  
PERFORMANCE.

**Karnasch®**  
PROFESSIONAL TOOLS

# HP-4

## Feine Kreuzverzahnung Fine cross cutting style



### ANWENDUNG · APPLICATION

Stahl Steel	Gehärteter Stahl Hardened steel	Edelstahl Stainless	Gusseisen Cast iron	Titan Titanium	Cermet	Nickel	Kupfer, Kupfer- legierungen Copper, copper alloys	Alu Alu	Kunststoffe GFK/CFK Plastics GRP/CRP
✓	✓	✓	✓	✓	✓	✓	✓	✓	✓

✓ OPTIMAL  
OPTIMAL  
✓ GUT  
GOOD

- Exzellente Kontrolle (Auch an schwierig zugänglichen Stellen)
  - Ruhiger Lauf
  - Kurze Späne
  - Gute Oberflächengüte
- Mittlere Zerspanleistung
- Für alle Stahlsorten wie:
  - Bis zu extra harten Stählen ca. 70 HRC
  - Gusseisen
  - Edelstahl (INOX)
  - Hochwärmfeste Werkstoffe wie z.B. Nickel-Basis + Kobalt Basislegierungen
- Excellent control (also at difficult to reach positions)
  - Smooth operation
  - Short chips
  - Good surface finish
- Medium cutting action
- For all kinds of steel:
  - Up to extra hard steel approx. 70 HRC
  - Cast iron
  - Stainless steel (INOX)
  - Heat-resistant substances, such as e.g. nickel based + cobalt based alloys

### Lagerprogramm + Katalogseiten • Stockrange + catalogue pages

ZYA	ZYB	WRC	KUD	TRE	RBF	SPG	-	KEL	SKM	WKN
A	B	C	D	E	F	G	H	L	M	N
Art. 11 5002 Art. 11 3002	Art. 11 5012 Art. 11 3012	Art. 11 5022 Art. 11 3022	Art. 11 5032 Art. 11 3032	Art. 11 5042 Art. 11 3042	Art. 11 5052 Art. 11 3052	Art. 11 5062 Art. 11 3062	Art. 11 5072 Art. 11 3072	Art. 11 5082 Art. 11 3082	Art. 11 5092 Art. 11 3092	Art. 11 5098 Art. 11 3098
818	818	819	820	820	821	821	822	822	823	823
Zylinder Cylinder	Zylinder + Stirnverzahnung Cylinder + end cut	Walzenrund- form Ball nosed cylinder	Kugel Ball	Tropfen Oval	Rundbogen Ball nosed tree	Spitzbogen Tree	Flamme Flame	Rundkegel Ball nosed cone	Spitzkegel Cone	Winkel Inverted cone



BLUE-TEC-beschichtet  
BLUE-TEC-coated

Die für Frässtifte optimierte und patentierte BLUE-TEC-Beschichtung ergibt einzigartige Standzeiten und Performance in allen Stahlsorten.

Patented BLUE-TEC coating, specifically designed for burrs, gives outstanding tool life and excellent performance on all metals.

Werkstoffgruppen			Bearbeitung	Schnittgeschwindigkeit (m/min)
Stahl, Stahlguss	Ungehärtete, nicht vergütete Stähle bis 1200 N/mm <sup>2</sup> (< 38 HRC)	Baustähle, Kohlenstoffstähle, Werkzeugstähle, unlegierte Stähle, Einsatzstähle, Stahlguss	Feines Zerspanen = mittlerer Materialabtrag	650-750
	Gehärtete, vergütete Stähle über 1200 N/mm <sup>2</sup> (> 38 HRC)	Werkzeugstähle, Vergütungsstähle, legierte Stähle, Stahlguss		450-600
Edelstahl (INOX)	Rost- und säurebeständige Stähle	Austenitische und ferritische Edelstähle	Feines Zerspanen = mittlerer Materialabtrag	450-600
NE-Metalle	Harte NE-Metalle	Bronze, Titan/Titanlegierungen, harte Alulegierungen (hoher Si-Anteil)	Feines Zerspanen = mittlerer Materialabtrag	450-600
	Hochwarmfeste Werkstoffe	Nickelbasis- und Kobaltbasislegierungen (Triebwerk- und Turbinenbau)		
Gusseisen	Graues Gusseisen, weißes Gusseisen	Gusseisen mit Lamellengraphit EN-GJL (GG), mit Kugelgraphit/Späroguss EN-GJS (GGG), weißer Temperguss EN-GJMW (GTW), schwarzer Temperguss EN-GJMB (GTS)	Feines Zerspanen = mittlerer Materialabtrag	650-750

Material groups			Application	Cutting speed m/min
Steel, cast steel	Non-hardened, non-heat treated-steels up to 1200 N/mm <sup>2</sup> (< 38 HRC)	Construction steels, carbon steels, tool steels, non-alloyed steels, case-hardened steels, cast steels	Fine machining = medium stock removal	650-750
	Hardened, heat-treated steels exceeding 1200 N/mm <sup>2</sup> (> 38 HRC)	Tool steels, tempering steels, alloyed steel, cast steels		450-600
Stainless steel (INOX)	Rust and acid-resistant steels	Austenitic and ferritic stainless steels	Fine machining = medium stock removal	450-600
Non-ferrous metals	Hard-non-ferrous metals	Bronze, titanium/titanium alloys, hard alu-alloys (high Si content)	Fine machining = medium stock removal	450-600
	High-temperature resistant materials	Nickel based alloys, cobalt based alloys (aircraft engine and turbine construction)		
Cast iron	Grey cast iron, white cast iron	Cast iron with flake graphite EN-GJL, with nodular graphite cast iron EN-GJS, white annealed cast iron EN-GJMW, black cast iron EN-GJMB	Fine machining = medium stock removal	650-750



Schnittgeschwindigkeit • Cutting speed (m/min)				
	450	600	650	750
∅ (mm)	Drehzahlen (min <sup>-1</sup> ) • Rotational speed (rpm)			
2	72.000	95.000	104.000	120.000
3	48.000	64.000	68.000	80.000
4	36.000	48.000	52.000	60.000
6	24.000	32.000	34.000	40.000
8	18.000	24.000	26.000	30.000
10	14.000	19.000	21.000	24.000
12	12.000	16.000	18.000	21.000
16	9.000	12.000	14.000	17.000







11 5022



**C** FORM / SHAPE **WRC**

Walzenrundform  
Ball nosed cylinder

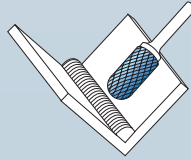

11 3022



Schnittdaten  
Cutting data

817

Film  
Movie

Art.	d1	l2	d2	l1	gelötet brazed	VHM solid	€
11 5022 020	• 2	11	3	38		✓	9,45
11 5022 025	• 3	14	3	38		✓	9,45
11 5022 030	• 3	14	3	50		✓	12,25
11 5022 032	•• 3	14	3	60		✓	12,80
11 5022 035	•• 3	14	3	75		✓	13,40
11 5022 040	•• 3	14	3	100		✓	16,90
11 5022 043	•• 3	30*(15)	6	60		✓	27,85
11 5022 045	• 4	16	6	50		✓	15,40
11 5022 046	•• 4	30*(15)	6	60		✓	28,45
11 5022 050	• 6	12,7	3	44	✓		15,10
11 5022 055	•• 6	18	6	50		✓	15,40
11 5022 056	•• 6	18	6	60		✓	19,30
11 5022 058	•• 6	18	6	80		✓	23,00
11 5022 060	•• 6	18	6	100	✓		28,15
11 5022 065	•• 6	18	6	150	✓		40,00
11 5022 070	• 6	25	6	50		✓	19,30
11 5022 075	• 8	20	6	65	✓		18,20
11 5022 080	• 8	20	6	170	✓		24,35
11 5022 085	• 10	20	6	65	✓		21,10
11 5022 090	• 10	20	6	170	✓		31,95
11 5022 095	• 10	25	6	70	✓		24,55
11 5022 100	• 12	20	6	65	✓		31,80
11 5022 105	• 12	25	6	70	✓		32,65
11 5022 110	• 12	25	6	175	✓		47,85
11 5022 115	•% 12	25	8	70	✓		17,80
11 5022 120	• 16	25	6	70	✓		40,40
11 5022 125	• 16	25	8	70	✓		40,40

Art.	d1	l2	d2	l1	gelötet brazed	VHM solid	€
11 3022 020	•% 2	11	3	38		✓	3,95
11 3022 025	• 3	14	3	38		✓	7,35
11 3022 032	•• 3	14	3	60		✓	10,75
11 3022 040	•• 3	14	3	100		✓	14,85
11 3022 043	•• 3	30*(15)	6	60		✓	25,75
11 3022 045	• 4	16	6	50		✓	13,35
11 3022 046	•• 4	30*(15)	6	60		✓	26,40
11 3022 050	• 6	12,7	3	44	✓		13,00
11 3022 055	•• 6	18	6	50		✓	13,35
11 3022 056	•• 6	18	6	60		✓	17,20
11 3022 058	•• 6	18	6	80		✓	20,95
11 3022 060	•• 6	18	6	100	✓		26,05
11 3022 075	• 8	20	6	65	✓		16,15
11 3022 080	• 8	20	6	170	✓		21,05
11 3022 085	• 10	20	6	65	✓		17,75
11 3022 090	• 10	20	6	170	✓		25,25
11 3022 095	• 10	25	6	70	✓		21,20
11 3022 105	• 12	25	6	70	✓		27,75
11 3022 110	•% 12	25	6	175	✓		21,10
11 3022 115	• 12	25	8	70	✓		27,95
11 3022 125	•% 16	25	8	70	✓		18,90

• Frässtifte speziell für Schlüsseldienste siehe Seite 838/839  
Burs specially for locksmiths see page 838/839

\* Von 30 mm sind 15 mm verzahnt  
15 mm by 30 mm are not machined

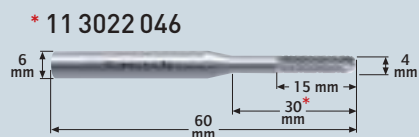
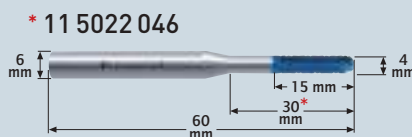
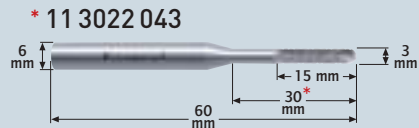

- 1
- 2
- 3
- 4
- 5
- 6
- 7
- 8
- 9
- 10

11 5032



**D FORM / SHAPE KUD**

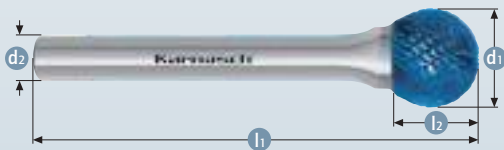

Kugel

Ball

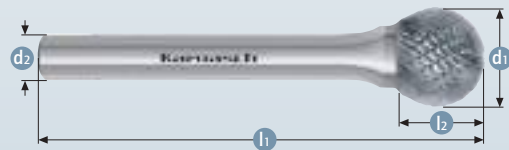
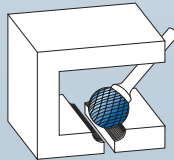

Schnittdaten Cutting data [i](#) 817

Film Movie [▶](#)

Art.	d1	l2	d2	l1	gelötet brazed	VHM solid	€
11 5032 020	• 2	1,8	3	38		✓	9,45
11 5032 025	• 3	2,5	3	38		✓	9,45
11 5032 030	• 3	2,5	3	50		✓	11,45
11 5032 035	• 3	2,5	3	75		✓	12,70
11 5032 040	• 3	2,5	6	50		✓	14,35
11 5032 045	• 4	3,4	3	38		✓	21,20
11 5032 050	• 6	5,0	3	38	✓		12,95
11 5032 055	• 6	4,7	6	50		✓	14,35
11 5032 060	• 8	6,0	6	52	✓		15,10
11 5032 065	• 8	6,0	6	180	✓		22,25
11 5032 070	• 10	8,0	6	54	✓		17,35
11 5032 075	• 10	8,0	6	185	✓		27,50
11 5032 080	• 12	11,0	6	56	✓		23,80
11 5032 085	• 12	11,0	8	56	✓		23,80
11 5032 090	• 12	11,0	6	162	✓		36,25
11 5032 095	• 16	14,0	6	60	✓		29,60
11 5032 100	• 16	14,0	8	60	✓		31,75

Art.	d1	l2	d2	l1	gelötet brazed	VHM solid	€
11 3032 020	• 2	1,8	3	38		✓	7,35
11 3032 025	• 3	2,5	3	38		✓	7,35
11 3032 030	• 3	2,5	3	50		✓	9,40
11 3032 035	• 3	2,5	3	75		✓	10,65
11 3032 040	• 3	2,5	6	50	✓		6,55
11 3032 045	• 4	3,4	3	38		✓	19,15
11 3032 050	• 6	5,0	3	38	✓		10,90
11 3032 055	• 6	4,7	6	50		✓	12,25
11 3032 060	• 8	6,0	6	52	✓		13,00
11 3032 065	• 8	6,0	6	180	✓		19,00
11 3032 070	• 10	8,0	6	54	✓		14,00
11 3032 080	• 12	11,0	6	56	✓		18,90
11 3032 085	• 12	11,0	8	56	✓		10,05
11 3032 090	• 12	11,0	6	162	✓		28,05
11 3032 095	• 16	14,0	6	60	✓		24,70
11 3032 100	• 16	14,0	8	60	✓		14,30

11 5042



**E FORM / SHAPE TRE**



Tropfen

Oval

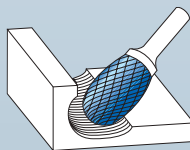

Schnittdaten Cutting data [i](#) 817

Film Movie [▶](#)

Art.	d1	l2	d2	l1	gelötet brazed	VHM solid	€
11 5042 010	• 3	6	3	38		✓	9,45
11 5042 015	• 6	10	3	42	✓		15,10
11 5042 020	• 6	10	6	50		✓	17,10
11 5042 025	• 8	15	6	60	✓		18,30
11 5042 030	• 10	16	6	60	✓		21,10
11 5042 035	• 12	22	6	67	✓		30,90
11 5042 040	• 12	22	8	67	✓		30,90
11 5042 045	• 16	25	6	70	✓		41,25
11 5042 050	• 16	25	8	70	✓		21,95

Art.	d1	l2	d2	l1	gelötet brazed	VHM solid	€
11 3042 010	• 3	6	3	38		✓	7,35
11 3042 015	• 6	10	3	42	✓		13,00
11 3042 020	• 6	10	6	50		✓	15,05
11 3042 025	• 8	15	6	60	✓		16,25
11 3042 030	• 10	16	6	60	✓		17,75
11 3042 035	• 12	22	6	67	✓		26,00
11 3042 040	• 12	22	8	67	✓		13,85
11 3042 045	• 16	25	6	70	✓		19,35
11 3042 050	• 16	25	8	70	✓		19,35

11 5052



## F FORM / SHAPE RBF



Rundbogen

Ball nosed tree

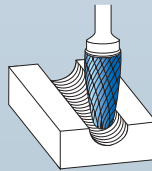

Schnittdaten  
Cutting data



817

Film  
Movie



817

Art.	d1	l2	d2	l1	gelötet brazed	VHM solid	€
11 5052 010	• 3	8	3	38		✓	9,45
11 5052 015	• 3	14	3	38		✓	9,45
11 5052 020	• 3	14	3	50		✓	12,25
11 5052 025	• 6	12	3	44	✓		15,10
11 5052 030	• 6	18	6	50		✓	16,05
11 5052 035	• 8	20	6	65	✓		19,45
11 5052 040	• 10	20	6	65	✓		21,50
11 5052 045	• 10	20	6	170	✓		31,45
11 5052 050	• 12	25	6	70	✓		30,20
11 5052 055	• 12	25	8	70	✓		30,20
11 5052 060	• 12	25	6	175	✓		44,55
11 5052 065	• 16	25	6	70	✓		40,00
11 5052 070	• 16	25	8	80	✓		21,25

Art.	d1	l2	d2	l1	gelötet brazed	VHM solid	€
11 3052 010	• 3	8	3	38		✓	4,00
11 3052 015	• 3	14	3	38		✓	7,35
11 3052 020	• 3	14	3	50		✓	5,40
11 3052 025	• 6	12	3	44	✓		13,00
11 3052 030	• 6	18	6	50		✓	14,00
11 3052 035	• 8	20	6	65	✓		17,40
11 3052 040	• 10	20	6	65	✓		18,15
11 3052 045	• 10	20	6	170	✓		24,70
11 3052 050	• 12	25	6	70	✓		25,30
11 3052 055	• 12	25	8	70	✓		13,45
11 3052 060	• 12	25	6	175	✓		36,30
11 3052 065	• 16	25	6	70	✓		35,10
11 3052 070	• 16	25	8	80	✓		18,70

11 5062



## G FORM / SHAPE SPG



Spitzbogen

Tree

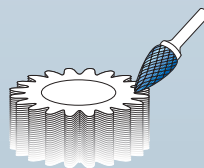

Schnittdaten  
Cutting data



817

Film  
Movie



817

Art.	d1	l2	d2	l1	gelötet brazed	VHM solid	€
11 5062 010	• 3	6	3	38		✓	9,45
11 5062 015	• 3	14	3	38		✓	9,45
11 5062 020	• 3	14	3	50		✓	11,15
11 5062 025	• 3	14	3	75		✓	13,25
11 5062 030	• 6	12	3	44	✓		15,10
11 5062 035	• 6	18	6	50		✓	16,05
11 5062 040	• 8	20	6	65	✓		18,80
11 5062 045	• 10	20	6	65	✓		21,95
11 5062 050	• 10	20	6	170	✓		17,50
11 5062 055	• 12	20	6	65	✓		29,75
11 5062 060	• 12	25	6	70	✓		29,75
11 5062 065	• 12	25	8	70	✓		29,75
11 5062 070	• 12	25	6	175	✓		44,15
11 5062 075	• 12	30	6	75	✓		17,60
11 5062 080	• 12	30	8	75	✓		17,20
11 5062 085	• 16	25	6	70	✓		40,40
11 5062 090	• 16	25	8	70	✓		23,10

Art.	d1	l2	d2	l1	gelötet brazed	VHM solid	€
11 3062 010	• 3	6	3	38		✓	3,95
11 3062 015	• 3	14	3	38		✓	7,35
11 3062 025	• 3	14	3	75		✓	11,15
11 3062 030	• 6	12	3	44	✓		13,00
11 3062 035	• 6	18	6	50		✓	14,00
11 3062 040	• 8	20	6	65	✓		16,70
11 3062 045	• 10	20	6	65	✓		18,60
11 3062 050	• 10	20	6	170	✓		26,25
11 3062 055	• 12	20	6	65	✓		13,25
11 3062 060	• 12	25	6	70	✓		24,85
11 3062 065	• 12	25	8	70	✓		13,25
11 3062 070	• 12	25	6	175	✓		35,95
11 3062 075	• 12	30	6	75	✓		14,65
11 3062 080	• 12	30	8	75	✓		14,65
11 3062 085	• 16	25	6	70	✓		18,90
11 3062 090	• 16	25	8	70	✓		20,50

• Sonderpreis / Sale Artikel. Lieferbar solange Vorrat.  
Special price / sale article. While stocks last.



11 5072



H FORM / SHAPE

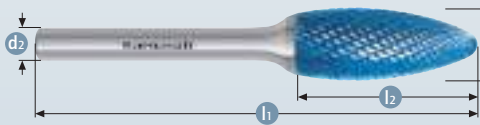

Flamme

Flame

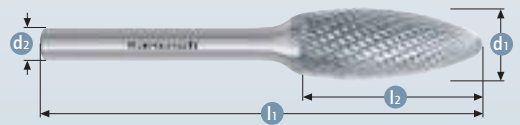
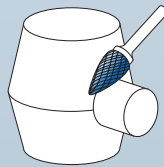

Schnittdaten  
Cutting data

Film  
Movie



Art.	d1	l2	d2	l1	gelötet brazed	VHM solid	€
11 5072 005	● 3	6	3	38		✓	9,45
11 5072 010	● 6	14	6	60		✓	18,60
11 5072 015	● 8	20	6	65	✓		20,20
11 5072 020	● 10	20	6	65	✓		34,05
11 5072 025	● 12	32	6	77	✓		40,00
11 5072 030	● 12	32	8	77	✓		40,00
11 5072 035	● 16	36	6	82	✓		57,00
11 5072 040	● 16	36	8	82	✓		33,35

Art.	d1	l2	d2	l1	gelötet brazed	VHM solid	€
11 3072 005	● 3	6	3	38		✓	7,35
11 3072 010	● 6	14	6	60		✓	16,55
11 3072 015	● 8	20	6	65	✓		18,10
11 3072 020	● 10	20	6	65	✓		30,70
11 3072 025	● 12	32	6	77	✓		35,10
11 3072 030	● 12	32	8	77	✓		18,70
11 3072 035	● 16	36	6	82	✓		27,75
11 3072 040	● 16	36	8	82	✓		30,10

11 5082



L FORM / SHAPE KEL

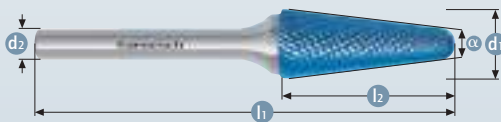

Rundkegel

Ball nosed cone

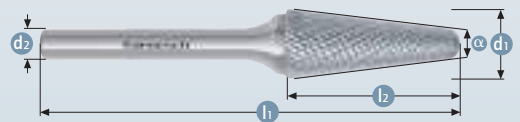
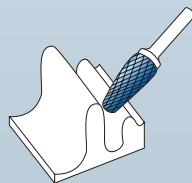

Schnittdaten  
Cutting data

Film  
Movie



Art.	d1	l2	d2	l1	gelötet brazed	VHM solid	α°	€
11 5082 005	● 3	10	3	38		✓	10°	9,45
11 5082 010	● 3	14	3	38		✓	8°	9,45
11 5082 015	● 6	16	3	48	✓		22°	15,10
11 5082 020	● 6	18	6	50	✓		14°	16,40
11 5082 025	● 8	25	6	70	✓		14°	20,60
11 5082 030	● 10	20	6	65	✓		14°	25,55
11 5082 035	● 10	30	6	75	✓		14°	25,55
11 5082 040	● 10	30	6	176	✓		14°	38,35
11 5082 045	● 12	32	6	77	✓		14°	30,65
11 5082 050	● 12	32	8	77	✓		14°	30,65
11 5082 055	● 12	32	6	182	✓		14°	50,30
11 5082 060	● 16	33	6	78	✓		14°	44,55
11 5082 065	● 16	33	8	78	✓		14°	44,55

Art.	d1	l2	d2	l1	gelötet brazed	VHM solid	α°	€
11 3082 010	● 3	14	3	38		✓	8°	7,35
11 3082 015	● 6	16	3	48	✓		22°	13,00
11 3082 020	● 6	18	6	50	✓		14°	7,80
11 3082 025	● 8	25	6	70	✓		14°	18,55
11 3082 030	● 10	20	6	65	✓		14°	22,20
11 3082 035	● 10	30	6	75	✓		14°	22,20
11 3082 040	● 10	30	6	176	✓		14°	17,15
11 3082 045	● 12	32	6	77	✓		14°	25,75
11 3082 050	● 12	32	8	77	✓		14°	25,75
11 3082 055	● 12	32	6	182	✓		14°	22,45
11 3082 060	● 16	33	6	78	✓		14°	21,10
11 3082 065	● 16	33	8	78	✓		14°	21,10



11 5092



## M FORM / SHAPE SKM

Spitzkegel

Cone

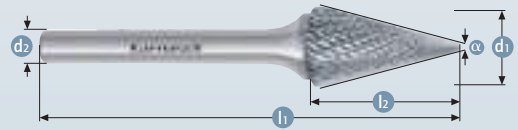
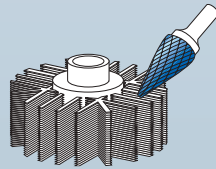
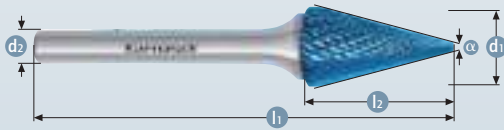

Schnittdaten Cutting data	Film Movie
817	

Art.	d1	l2	d2	l1	gelötet brazed	VHM solid	α°	€
11 5092 010	● 3	8	3	38		✓	18°	9,45
11 5092 015	● 3	11	3	38		✓	14°	9,45
11 5092 020	● 3	15	3	38		✓	10°	9,45
11 5092 025	● 6	12	3	48	✓		22°	15,10
11 5092 030	● 6	20	6	50		✓	14°	16,40
11 5092 035	● 8	18	6	63	✓		13°	18,75
11 5092 040	● 10	20	6	65	✓		28°	24,00
11 5092 045	● 12	25	6	70	✓		28°	29,75
11 5092 055	● 16	26	6	74	✓		33°	42,15
11 5092 060	● 16	26	8	74	✓		33°	22,40

Art.	d1	l2	d2	l1	gelötet brazed	VHM solid	α°	€
11 3092 010	● 3	8	3	38		✓	18°	7,35
11 3092 015	● 3	11	3	38		✓	14°	7,35
11 3092 020	● 3	15	3	38		✓	10°	7,35
11 3092 025	● 6	12	3	48	✓		22°	13,00
11 3092 030	● 6	20	6	50		✓	14°	14,35
11 3092 035	● 8	18	6	63	✓		13°	16,65
11 3092 040	● 10	20	6	65	✓		28°	20,65
11 3092 045	● 12	25	6	70	✓		28°	24,85
11 3092 050	● 12	25	8	70	✓		28°	13,25
11 3092 055	● 16	26	6	74	✓		33°	19,80
11 3092 060	● 16	26	8	74	✓		33°	19,80

11 5098



## N FORM / SHAPE WKN

Winkel

Inverted cone



Schnittdaten Cutting data	Film Movie
817	

Art.	d1	l2	d2	l1	gelötet brazed	VHM solid	α°	€
11 5098 015	● 6	8	6	50		✓	10°	17,45
11 5098 020	● 10	10	6	55	✓		13°	21,65
11 5098 025	● 12	13	6	58	✓		30°	32,60

Art.	d1	l2	d2	l1	gelötet brazed	VHM solid	α°	€
11 3098 015	● 6	8	6	50		✓	10°	15,40
11 3098 020	● 10	10	6	55	✓		13°	18,30
11 3098 025	● 12	13	6	58	✓		30°	27,70

● Sonderpreis / Sale Artikel. Lieferbar solange Vorrat.  
Special price / sale article. While stocks last.



# HP-5

## Extrem feine Einfachverzahnung Extremely fine single cutting style



### ANWENDUNG · APPLICATION

Stahl Steel	Gehärteter Stahl Hardened steel	Edelstahl Stainless	Gusseisen Cast iron	Titan Titanium	Cermet Cermet	Nickel Nickel	Kupfer, Kupfer- legierungen Copper, copper alloys	Alu Alu	Kunststoffe GFK/CFK Plastics GRP/CRP
✓	✓	✓	✓	✓	✓	✓	✓	✓	✓

✓ OPTIMAL  
OPTIMAL  
✓ GUT  
GOOD

- Exzellente Oberflächengüte
- Vorzugsweise für feines Entgraten von allen Stahlsorten wie:
  - Bis zu extra harten Stählen ca. 70 HRC
  - Gusseisen
  - Edelstahl (INOX)
  - Hochwärmefeste Werkstoffe wie z.B. Nickel-Basis + Kobalt-Basis + Kobalt-Basis Legierungen

- Excellent surface finish
- Preferred for fine deburring all ferrous metals, such as:
  - Up to extra hard steel approx. 70 HRC
  - Cast iron
  - Stainless steel (INOX)
  - Heat resistant substances, such as, e.g. nickel based + cobalt based alloys

### Lagerprogramm + Katalogseiten • Stockrange + catalogue pages

ZYA	ZYB	WRC	KUD	TRE	RBF	SPG	-	KEL	SKM
A	B	C	D	E	F	G	H	L	M
Art. 11 5003 Art. 11 3003	Art. 11 5013 Art. 11 3013	Art. 11 5023 Art. 11 3023	Art. 11 5033 Art. 11 3033	Art. 11 5043 Art. 11 3043	Art. 11 5053 Art. 11 3053	Art. 11 5063 Art. 11 3063	Art. 11 5073 Art. 11 3073	Art. 11 5083 Art. 11 3083	Art. 11 5093 Art. 11 3093
826	826	827	827	828	828	829	829	830	830
Zylinder Cylinder	Zylinder + Stirn- verzahnung Cylinder + end cut	Walzenrund- form Ball nosed cylinder	Kugel Ball	Tropfen Oval	Rundbogen Ball nosed tree	Spitzbogen Tree	Flamme Flame	Rundkegel Ball nosed cone	Spitzkegel Cone



BLUE-TEC-beschichtet  
BLUE-TEC-coated



Die für Frässtifte optimierte und patentierte BLUE-TEC-Beschichtung ergibt einzigartige Standzeiten und Performance in allen Stahlsorten.

Patented BLUE-TEC coating, specifically designed for burrs, gives outstanding tool life and excellent performance on all metals.

Werkstoffgruppen			Bearbeitung	Schnittgeschwindigkeit (m/min)
Stahl, Stahlguss	Ungehärtete, nicht vergütete Stähle bis 1200 N/mm <sup>2</sup> (< 38 HRC)	Baustähle, Kohlenstoffstähle, Werkzeugstähle, unlegierte Stähle, Einsatzstähle, Stahlguss	Feines Zerspanen = mittlerer Materialabtrag	650-750
	Gehärtete, vergütete Stähle über 1200 N/mm <sup>2</sup> (> 38 HRC)	Werkzeugstähle, Vergütungsstähle, legierte Stähle, Stahlguss		450-600
Edelstahl (INOX)	Rost- und säurebeständige Stähle	Austenitische und ferritische Edelstähle	Feines Zerspanen = mittlerer Materialabtrag	450-600
NE-Metalle	Harte NE-Metalle	Bronze, Titan/Titanlegierungen, harte Alulegierungen (hoher Si-Anteil)	Feines Zerspanen = mittlerer Materialabtrag	450-600
	Hochwarmfeste Werkstoffe	Nickelbasis- und Kobaltbasislegierungen (Triebwerk- und Turbinenbau)		
Gusseisen	Graues Gusseisen, weißes Gusseisen	Gusseisen mit Lamellengraphit EN-GJL (GG), mit Kugelgraphit/Späroguss EN-GJS (GGG), weißer Temperguss EN-GJMW (GTW), schwarzer Temperguss EN-GJMB (GTS)	Feines Zerspanen = mittlerer Materialabtrag	650-750

Material groups			Application	Cutting speed m/min
Steel, cast steel	Non-hardened, non-heat treated-steels up to 1200 N/mm <sup>2</sup> (< 38 HRC)	Construction steels, carbon steels, tool steels, non-alloyed steels, case-hardened steels, cast steels	Fine machining = medium stock removal	650-750
	Hardened, heat-treated steels exceeding 1200 N/mm <sup>2</sup> (> 38 HRC)	Tool steels, tempering steels, alloyed steel, cast steels		450-600
Stainless steel (INOX)	Rust and acid-resistant steels	Austenitic and ferritic stainless steels	Fine machining = medium stock removal	450-600
Non-ferrous metals	Hard-non-ferrous metals	Bronze, titanium/titanium alloys, hard alu-alloys (high Si content)	Fine machining = medium stock removal	450-600
	High-temperature resistant materials	Nickel based alloys, cobalt based alloys (aircraft engine and turbine construction)		
Cast iron	Grey cast iron, white cast iron	Cast iron with flake graphite EN-GJL, with nodular graphite cast iron EN-GJS, white annealed cast iron EN-GJMW, black cast iron EN-GJMB	Fine machining = medium stock removal	650-750



Schnittgeschwindigkeit • Cutting speed (m/min)				
	450	600	650	750
∅ (mm)	Drehzahlen (min <sup>-1</sup> ) • Rotational speed (rpm)			
2	72.000	95.000	104.000	120.000
3	48.000	64.000	68.000	80.000
4	36.000	48.000	52.000	60.000
6	24.000	32.000	34.000	40.000
8	18.000	24.000	26.000	30.000
10	14.000	19.000	21.000	24.000
12	12.000	16.000	18.000	21.000
16	9.000	12.000	14.000	17.000







11 5023



## C FORM / SHAPE WRC

Walzenrundform  
Ball nosed cylinder

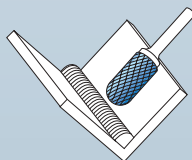

Schnittdaten  
Cutting data



Film  
Movie



Art.	d1	l2	d2	l1	gelötet brazed	VHM solid	€
11 5023 020	• 2	11	3	38		✓	9,45
11 5023 025	• 3	14	3	38		✓	9,45
11 5023 030	• 3	14	3	50		✓	12,25
11 5023 035	• 3	14	3	75		✓	13,40
11 5023 040	• 3	14	3	100		✓	16,05
11 5023 045	• 4	16	6	50		✓	14,30
11 5023 050	• 6	12,7	3	44	✓		14,25
11 5023 055	• 6	18	6	50		✓	14,30
11 5023 060	• 6	18	6	100	✓		26,00
11 5023 065	• 6	18	6	150	✓		26,45
11 5023 070	• 6	25	6	50	✓		10,50
11 5023 075	• 8	20	6	65	✓		17,10
11 5023 080	• 8	20	6	170	✓		24,90
11 5023 085	• 10	20	6	65	✓		19,90
11 5023 090	• 10	20	6	170	✓		15,85
11 5023 095	• 10	25	6	70	✓		12,05
11 5023 100	• 12	20	6	65	✓		16,90
11 5023 105	• 12	25	6	70	✓		30,90
11 5023 110	• 12	25	6	175	✓		23,65
11 5023 115	• 12	25	8	70	✓		17,80
11 5023 120	• 16	25	6	70	✓		19,95
11 5023 125	• 16	25	8	70	✓		21,45

Art.	d1	l2	d2	l1	gelötet brazed	VHM solid	€
11 3023 020	• 2	11	3	38		✓	3,95
11 3023 025	• 3	14	3	38		✓	7,35
11 3023 030	• 3	14	3	50		✓	10,15
11 3023 035	• 3	14	3	75		✓	11,35
11 3023 040	• 3	14	3	100		✓	7,60
11 3023 045	• 4	16	6	50		✓	12,25
11 3023 050	• 6	12,7	3	44	✓		12,20
11 3023 055	• 6	18	6	50		✓	12,25
11 3023 060	• 6	18	6	100	✓		12,75
11 3023 065	• 6	18	6	150	✓		17,95
11 3023 070	• 6	25	6	50	✓		9,40
11 3023 075	• 8	20	6	65	✓		15,05
11 3023 080	• 8	20	6	170	✓		21,65
11 3023 085	• 10	20	6	65	✓		16,50
11 3023 090	• 10	20	6	170	✓		12,30
11 3023 095	• 10	25	6	70	✓		10,30
11 3023 100	• 12	20	6	65	✓		14,30
11 3023 105	• 12	25	6	70	✓		26,00
11 3023 110	• 12	25	6	175	✓		19,35
11 3023 115	• 12	25	8	70	✓		14,90
11 3023 120	• 16	25	6	70	✓		32,60
11 3023 125	• 16	25	8	70	✓		18,90

11 5033



## D FORM / SHAPE KUD

Kugel  
Ball

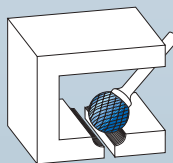

Schnittdaten  
Cutting data



Film  
Movie



Art.	d1	l2	d2	l1	gelötet brazed	VHM solid	€
11 5033 020	• 2	1,8	3	38		✓	9,45
11 5033 025	• 3	2,5	3	38		✓	9,45
11 5033 030	• 3	2,5	3	50		✓	11,45
11 5033 035	• 3	2,5	3	75		✓	12,70
11 5033 040	• 3	2,5	6	50	✓		7,10
11 5033 045	• 4	3,0	3	38		✓	19,90
11 5033 050	• 6	5,0	3	38	✓		12,95
11 5033 055	• 6	4,7	6	50		✓	13,35
11 5033 060	• 8	6,0	6	52	✓		14,20
11 5033 065	• 8	6,0	6	180	✓		20,70
11 5033 070	• 10	8,0	6	54	✓		17,35
11 5033 075	• 10	8,0	6	185	✓		25,75
11 5033 080	• 12	11,0	6	56	✓		23,80
11 5033 085	• 12	11,0	8	56	✓		12,65
11 5033 090	• 12	11,0	6	162	✓		33,90
11 5033 095	• 16	14,0	6	60	✓		27,60
11 5033 100	• 16	14,0	8	60	✓		30,15

Art.	d1	l2	d2	l1	gelötet brazed	VHM solid	€
11 3033 020	• 2	1,8	3	38		✓	7,35
11 3033 025	• 3	2,5	3	38		✓	7,35
11 3033 030	• 3	2,5	3	50		✓	9,40
11 3033 035	• 3	2,5	3	75		✓	5,70
11 3033 040	• 3	2,5	6	50	✓		6,00
11 3033 045	• 4	3,0	3	38		✓	17,80
11 3033 050	• 6	5,0	3	38	✓		10,90
11 3033 055	• 6	4,7	6	50		✓	11,30
11 3033 060	• 8	6,0	6	52	✓		12,15
11 3033 065	• 8	6,0	6	180	✓		17,40
11 3033 070	• 10	8,0	6	54	✓		14,00
11 3033 075	• 10	8,0	6	185	✓		10,15
11 3033 080	• 12	11,0	6	56	✓		18,90
11 3033 085	• 12	11,0	8	56	✓		10,05
11 3033 090	• 12	11,0	6	162	✓		25,70
11 3033 095	• 16	14,0	6	60	✓		12,05
11 3033 100	• 16	14,0	8	60	✓		13,45

• Sonderpreis / Sale Artikel. Lieferbar solange Vorrat.  
Special price / sale article. While stocks last.



11 5043



E FORM / SHAPE TRE

Tropfen

Oval

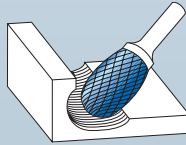

Schnittdaten  
Cutting data

Film  
Movie



Art.	d1	l2	d2	l1	gelötet brazed	VHM solid	€
11 5043 010	• 3	6	3	38		✓	9,45
11 5043 015	• 6	10	3	42	✓		14,25
11 5043 020	• 6	10	6	50		✓	15,85
11 5043 025	• 8	15	6	60	✓		18,30
11 5043 030	• 10	16	6	60	✓		19,90
11 5043 035	• 12	22	6	67	✓		29,10
11 5043 040	• 12	22	8	67	✓		16,45
11 5043 050	• 16	25	8	70	✓		21,95

Art.	d1	l2	d2	l1	gelötet brazed	VHM solid	€
11 3043 010	• 3	6	3	38		✓	7,35
11 3043 015	• 6	10	3	42	✓		12,20
11 3043 020	• 6	10	6	50		✓	13,80
11 3043 025	• 8	15	6	60	✓		16,25
11 3043 030	• 10	16	6	60	✓		16,50
11 3043 035	• 12	22	6	67	✓		24,20
11 3043 040	• 12	22	8	67	✓		13,85
11 3043 045	• 16	25	6	70	✓		17,90

11 5053



F FORM / SHAPE RBF

Rundbogen

Ball nosed tree

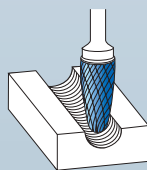

Schnittdaten  
Cutting data

Film  
Movie



Art.	d1	l2	d2	l1	gelötet brazed	VHM solid	€
11 5053 010	• 3	8	3	38		✓	9,45
11 5053 015	• 3	14	3	38		✓	9,45
11 5053 020	• 3	14	3	50		✓	12,25
11 5053 025	• 6	12	3	44	✓		14,25
11 5053 030	• 6	18	6	50		✓	14,90
11 5053 035	• 8	20	6	65	✓		19,45
11 5053 040	• 10	20	6	65	✓		19,50
11 5053 045	• 10	20	6	170	✓		29,45
11 5053 050	• 12	25	6	70	✓		28,80
11 5053 055	• 12	25	8	70	✓		16,40
11 5053 060	• 12	25	6	175	✓		22,00
11 5053 070	• 16	25	8	80	✓		21,25

Art.	d1	l2	d2	l1	gelötet brazed	VHM solid	€
11 3053 010	• 3	8	3	38		✓	3,95
11 3053 015	• 3	14	3	38		✓	7,35
11 3053 020	• 3	14	3	50		✓	5,40
11 3053 025	• 6	12	3	44	✓		12,20
11 3053 030	• 6	18	6	50		✓	12,85
11 3053 035	• 8	20	6	65	✓		17,40
11 3053 040	• 10	20	6	65	✓		16,15
11 3053 045	• 10	20	6	170	✓		12,05
11 3053 050	• 12	25	6	70	✓		23,90
11 3053 055	• 12	25	8	70	✓		13,45
11 3053 060	• 12	25	6	175	✓		17,75
11 3053 065	• 16	25	6	70	✓		17,55
11 3053 070	• 16	25	8	80	✓		18,70



11 5063



## G FORM / SHAPE SPG



Spitzbogen

Tree

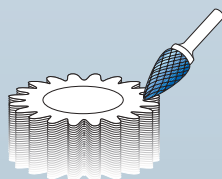

Schnittdaten  
Cutting data



825

Film  
Movie



Art.	d1	l2	d2	l1	gelötet brazed	VHM solid	€
11 5063 010	• 3	6	3	38		✓	9,45
11 5063 015	• 3	14	3	38		✓	9,45
11 5063 020	• 3	14	3	50		✓	11,15
11 5063 025	• 3	14	3	75		✓	13,25
11 5063 030	• 6	12	3	44	✓		14,25
11 5063 035	• 6	18	6	50		✓	14,90
11 5063 040	• 8	20	6	65	✓		17,65
11 5063 045	• 10	20	6	65	✓		20,60
11 5063 050	• 10	20	6	170	✓		16,35
11 5063 055	• 12	20	6	65	✓		15,40
11 5063 060	• 12	25	6	70	✓		28,40
11 5063 065	• 12	25	8	70	✓		29,75
11 5063 070	• 12	25	6	175	✓		41,15
11 5063 075	• 12	30	6	75	✓		29,15
11 5063 080	• 12	30	8	75	✓		16,80
11 5063 085	• 16	25	6	70	✓		19,90
11 5063 090	• 16	25	8	70	✓		21,25

Art.	d1	l2	d2	l1	gelötet brazed	VHM solid	€
11 3063 010	• 3	6	3	38		✓	7,35
11 3063 015	• 3	14	3	38		✓	7,35
11 3063 020	• 3	14	3	50		✓	9,05
11 3063 030	• 6	12	3	44	✓		12,20
11 3063 035	• 6	18	6	50		✓	12,85
11 3063 040	• 8	20	6	65	✓		15,55
11 3063 045	• 10	20	6	65	✓		17,25
11 3063 050	• 10	20	6	170	✓		12,80
11 3063 055	• 12	20	6	65	✓		12,50
11 3063 060	• 12	25	6	70	✓		23,50
11 3063 065	• 12	25	8	70	✓		13,25
11 3063 070	• 12	25	6	175	✓		17,55
11 3063 075	• 12	30	6	75	✓		24,20
11 3063 080	• 12	30	8	75	✓		14,20
11 3063 085	• 16	25	6	70	✓		32,55
11 3063 090	• 16	25	8	70	✓		18,70

11 5073



## H FORM / SHAPE



Flamme

Flame

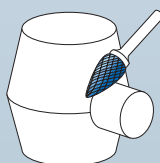

Schnittdaten  
Cutting data



825

Film  
Movie



Art.	d1	l2	d2	l1	gelötet brazed	VHM solid	€
11 5073 005	• 3	6	3	38		✓	9,45
11 5073 010	• 6	14	6	60		✓	18,60
11 5073 015	• 8	20	6	65	✓		19,05
11 5073 020	• 10	20	6	65	✓		34,05
11 5073 025	• 12	32	6	77	✓		40,00
11 5073 030	• 12	32	8	77	✓		21,25
11 5073 035	• 16	36	6	82	✓		28,00
11 5073 040	• 16	36	8	82	✓		29,95

Art.	d1	l2	d2	l1	gelötet brazed	VHM solid	€
11 3073 005	• 3	6	3	38		✓	7,35
11 3073 010	• 6	14	6	60		✓	16,55
11 3073 015	• 8	20	6	65	✓		17,00
11 3073 020	• 10	20	6	65	✓		30,70
11 3073 025	• 12	32	6	77	✓		35,10
11 3073 030	• 12	32	8	77	✓		35,10
11 3073 035	• 16	36	6	82	✓		47,75
11 3073 040	• 16	36	8	82	✓		50,30

• Sonderpreis / Sale Artikel. Lieferbar solange Vorrat.  
Special price / sale article. While stocks last.



11 5083



L FORM / SHAPE

KEL



Rundkegel

Ball nosed cone

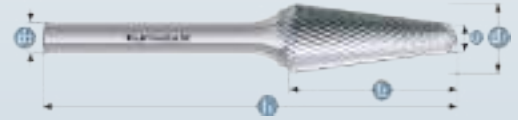
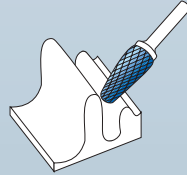

Schnittdaten  
Cutting data

Film  
Movie



Art.	d1	l2	d2	l1	gelötet brazed	VHM solid	α°	€
11 5083 005	• 3	10	3	38		✓	10°	9,45
11 5083 010	• 3	14	3	38		✓	8°	9,45
11 5083 015	• 6	16	3	48	✓		22°	15,10
11 5083 020	• 6	18	6	50		✓	14°	15,15
11 5083 025	• 8	25	6	70	✓		14°	19,30
11 5083 030	• 10	20	6	65	✓		14°	25,55
11 5083 035	• 10	30	6	75	✓		14°	24,00
11 5083 040	• 10	30	6	176	✓		14°	18,95
11 5083 045	• 12	32	6	77	✓		14°	30,65
11 5083 050	• 12	32	8	77	✓		14°	16,25
11 5083 055	• 12	32	6	182	✓		14°	24,70
11 5083 060	• 16	33	6	78	✓		14°	44,55
11 5083 065	• 16	33	8	78	✓		14°	44,55

Art.	d1	l2	d2	l1	gelötet brazed	VHM solid	α°	€
11 3083 005	• 3	10	3	38		✓	10°	3,95
11 3083 010	• 3	14	3	38		✓	8°	7,35
11 3083 015	• 6	16	3	48	✓		22°	13,00
11 3083 020	• 6	18	6	50		✓	14°	13,10
11 3083 025	• 8	25	6	70	✓		14°	17,20
11 3083 030	• 10	20	6	65	✓		14°	22,20
11 3083 035	• 10	30	6	75	✓		14°	20,65
11 3083 040	• 10	30	6	176	✓		14°	15,45
11 3083 045	• 12	32	6	77	✓		14°	25,75
11 3083 050	• 12	32	8	77	✓		14°	13,70
11 3083 055	• 12	32	6	182	✓		14°	38,30
11 3083 060	• 16	33	6	78	✓		14°	21,10
11 3083 065	• 16	33	8	78	✓		14°	21,10

11 5093



M FORM / SHAPE

SKM



Spitzkegel

Cone

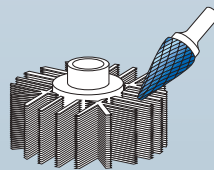

Schnittdaten  
Cutting data

Film  
Movie



Art.	d1	l2	d2	l1	gelötet brazed	VHM solid	α°	€
11 5093 010	• 3	8	3	38		✓	18°	9,45
11 5093 015	• 3	11	3	38		✓	14°	9,45
11 5093 020	• 3	15	3	38		✓	10°	9,45
11 5093 025	• 6	12	3	48	✓		22°	14,25
11 5093 030	• 6	20	6	50		✓	14°	15,15
11 5093 035	• 8	18	6	63	✓		13°	18,75
11 5093 040	• 10	20	6	65	✓		28°	24,00
11 5093 045	• 12	25	6	70	✓		28°	29,75
11 5093 050	• 12	25	8	70	✓		28°	15,80
11 5093 055	• 16	26	6	74	✓		33°	39,50

Art.	d1	l2	d2	l1	gelötet brazed	VHM solid	α°	€
11 3093 010	• 3	8	3	38		✓	18°	7,35
11 3093 015	• 3	11	3	38		✓	14°	7,35
11 3093 020	• 3	15	3	38		✓	10°	7,35
11 3093 025	• 6	12	3	48	✓		22°	12,20
11 3093 030	• 6	20	6	50		✓	14°	13,10
11 3093 035	• 8	18	6	63	✓		13°	16,65
11 3093 040	• 10	20	6	65	✓		28°	20,65
11 3093 045	• 12	25	6	70	✓		28°	24,85
11 3093 050	• 12	25	8	70	✓		28°	13,25
11 3093 055	• 16	26	6	74	✓		33°	18,40
11 3093 060	• 16	26	8	74	✓		33°	19,80

• Sonderpreis / Sale Artikel. Lieferbar solange Vorrat.  
Special price / sale article. While stocks last.

- 1
- 2
- 3
- 4
- 5
- 6
- 7
- 8
- 9
- 10

Qualitätsprodukte für die Metallbearbeitung.  
Quality products for metalworking.



→ AUTOMOBILINDUSTRIE  
→ AUTOMOTIVE

→ LUFTFAHRTINDUSTRIE  
→ AEROSPACE INDUSTRY

→ RAUMFAHRTINDUSTRIE  
→ OUTER SPACE INDUSTRY



FRÄSSTIFTE SPEZIELL FÜR ABRASIVE WERKSTOFFE WIE GFK UND CFK, AL > 30% SI/ MAGNESIUM SIEHE HP-7 VERZÄHNUNG SEITE 784-791 SOWIE UNSERE ART. 11 6001, 11 6002, 11 6003, 11 6004 SIEHE SEITE 843

ROTARY BURRS SPECIALLY DESIGNED FOR ABRASIVE MATERIALS SUCH AS GRP AND CFRP AND AL > 30% SI/MAGNESIUM SEE HP-7 CUT ON PAGE 784-791 AND OUR ART. 11 6001, 11 6002, 11 6003, 11 6004 SEE PAGE 843

1



2



3



4



5



6



7



8



9











10

## HP-11

### Extrem feine Kreuzverzahnung Extremely fine cross cutting style

#### ANWENDUNG · APPLICATION

 Stahl Steel	 Gehärteter Stahl Hardened steel	 Edelstahl Stainless	 Gusseisen Cast iron	 Titan Titanium	 Cermet Cermet	 Nickel Nickel	 Kupfer, Kupferlegierungen Copper, copper alloys	 Alu Alu	 Kunststoffe GFK/CFK Plastics GRP/CRP	<input checked="" type="checkbox"/> OPTIMAL <input checked="" type="checkbox"/> OPTIMAL <input checked="" type="checkbox"/> GUT <input checked="" type="checkbox"/> GOOD
---	---	---	---	--	---	--	---	---	--	---

- Exzellent für die: Feinbearbeitung · Extrem feine Putzarbeiten · Korrekturen im Werkzeug- und Formenbau · Schleifen/ Schärfen von Schnittwerkzeugen
  - Eigenschaften: Gutes Abtragverhalten · Vibrationsarm · Exzellente Kontrolle/Führung im Handeinsatz · Hohe Oberflächengüte
  - Vorteile: Es können nahezu alle Werkstoffe bis zu einer Härte von 70 HRC bearbeitet werden.  
**In diesem Bereich werden üblicherweise Keramik-Schleifstifte verwendet.**
- Die neue Micro-Verzahnung garantiert:
- Keine Geometrieänderung durch Abnutzung/Verschleiß gegenüber Schleifstifte.
  - Wesentlich höheren Materialabtrag sowie Standzeit gegenüber Schleifstifte

- Excellent for: Finishing · Extremely fine cleaning work · Corrections in tool and mould construction · Grinding/ sharpening of cutting tools
- Characteristics: Good stock removal · Low vibrations · Excellent control and guidance under handheld conditions. High surface quality
- Advantages: Micro-cut can be used for work on almost all materials up to a hardness of 70 HRC.  
**In this area usually mounted points are used.**
- Unlike with mounted points, there is no change in geometry due to wear and tear.
- Unlike with mounted points, there is much higher performance, surface quality and lifetime

#### Lagerprogramm + Katalogseiten · Stockrange + catalogue pages

ZYA	ZYB	WRC	KUD	RBF	SPG
<b>A</b>	<b>B</b>	<b>C</b>	<b>D</b>	<b>F</b>	<b>G</b>
Art. 11 6080 Art. 11 4080	Art. 11 6081 Art. 11 4081	Art. 11 6082 Art. 11 4082	Art. 11 6083 Art. 11 4083	Art. 11 6084 Art. 11 4084	Art. 11 6085 Art. 11 4085
					
834	834	835	835	836	836
Zylinder Cylinder	Zylinder + Stirnverzahnung Cylinder + end cut	Walzenrundform Ball nosed cylinder	Kugel Ball	Rundbogen Ball nosed tree	Spitzbogen Tree



BLUE-TEC-beschichtet  
BLUE-TEC-coated

Die für Frässtifte optimierte und patentierte BLUE-TEC-Beschichtung ergibt einzigartige Standzeiten und Performance in allen Stahlsorten.

Patented BLUE-TEC coating, specifically designed for burrs, gives outstanding tool life and excellent performance on all metals.

Werkstoffgruppen			Bearbeitung	Schnittgeschwindigkeit (m/min)
Stahl, Stahlguss	Ungehärtete, nicht vergütete Stähle bis 1200 N/mm <sup>2</sup> (< 38 HRC)	Baustähle, Kohlenstoffstähle, Werkzeugstähle, unlegierte Stähle, Einsatzstähle, Stahlguss	Feines Zerspanen = mittlerer Materialabtrag	650-750
	Gehärtete, vergütete Stähle über 1200 N/mm <sup>2</sup> (> 38 HRC)	Werkzeugstähle, Vergütungsstähle, legierte Stähle, Stahlguss		450-600
Edelstahl (INOX)	Rost- und säurebeständige Stähle	Austenitische und ferritische Edelstähle	Feines Zerspanen = mittlerer Materialabtrag	450-600
NE-Metalle	Harte NE-Metalle	Bronze, Titan/Titanlegierungen, harte Alulegierungen (hoher Si-Anteil)	Feines Zerspanen = mittlerer Materialabtrag	450-600
	Hochwarmfeste Werkstoffe	Nickelbasis- und Kobaltbasislegierungen (Triebwerk- und Turbinenbau)		
Gusseisen	Graues Gusseisen, weißes Gusseisen	Gusseisen mit Lamellengraphit EN-GJL (GG), mit Kugelgraphit/Späroguss EN-GJS (GGG), weißer Temperguss EN-GJMW (GTW), schwarzer Temperguss EN-GJMB (GTS)	Feines Zerspanen = mittlerer Materialabtrag	600-750

Material groups			Application	Cutting speed m/min
Steel, cast steel	Non-hardened, non-heat treated-steels up to 1200 N/mm <sup>2</sup> (< 38 HRC)	Construction steels, carbon steels, tool steels, non-alloyed steels, case-hardened steels, cast steels	Fine machining = medium stock removal	650-750
	Hardened, heat-treated steels exceeding 1200 N/mm <sup>2</sup> (> 38 HRC)	Tool steels, tempering steels, alloyed steel, cast steels		450-600
Stainless steel (INOX)	Rust and acid-resistant steels	Austenitic and ferritic stainless steels	Fine machining = medium stock removal	450-600
Non-ferrous metals	Hard-non-ferrous metals	Bronze, titanium/titanium alloys, hard alu-alloys (high Si content)	Fine machining = medium stock removal	450-600
	High-temperature resistant materials	Nickel based alloys, cobalt based alloys (aircraft engine and turbine construction)		
Cast iron	Grey cast iron, white cast iron	Cast iron with flake graphite EN-GJL, with nodular graphite cast iron EN-GJS, white annealed cast iron EN-GJMW, black cast iron EN-GJMB	Fine machining = medium stock removal	600-750



Schnittgeschwindigkeit • Cutting speed (m/min)				
	450	600	650	750
Ø (mm)	Drehzahlen (min <sup>-1</sup> ) • Rotational speed (rpm)			
2	72.000	95.000	104.000	120.000
3	48.000	64.000	68.000	80.000
4	36.000	48.000	52.000	60.000
6	24.000	32.000	34.000	40.000
8	18.000	24.000	26.000	30.000
10	14.000	19.000	21.000	24.000
12	12.000	16.000	18.000	21.000



11 6080



**A FORM / SHAPE ZYA**



Zylinder ohne Stirnverzahnung

Cylinder without end cut

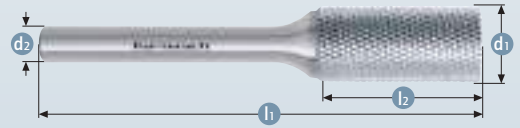
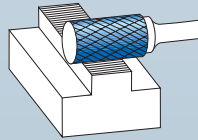

Schnittdaten  
Cutting data

Film  
Movie



Art.	d1	l2	d2	l1	gelötet brazed	VHM solid	€
11 6080 010	• 2	11	3	38		✓	20,10
11 6080 020	• 3	14	3	38		✓	20,10
11 6080 030	• 4	7	3	38		✓	19,95
11 6080 040	• 6	5	3	37	✓		21,00
11 6080 050	• 6	18	6	50		✓	20,70
11 6080 060	• 8	20	6	65	✓		24,85
11 6080 070	• 10	20	6	65	✓		28,35
11 6080 080	• 12	25	6	70	✓		36,15

Art.	d1	l2	d2	l1	gelötet brazed	VHM solid	€
11 4080 010	• 2	11	3	38		✓	18,05
11 4080 020	• 3	14	3	38		✓	18,05
11 4080 030	• 4	7	3	38		✓	17,90
11 4080 040	• 6	5	3	37	✓		18,95
11 4080 050	• 6	18	6	50		✓	18,65
11 4080 060	• 8	20	6	65	✓		22,80
11 4080 070	• 10	20	6	65	✓		25,00
11 4080 080	• 12	25	6	70	✓		31,20

11 6081



**B FORM / SHAPE ZYB**

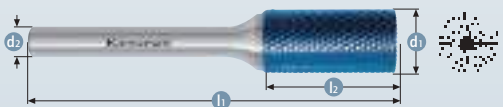

Zylinder mit Stirnverzahnung

Cylinder with end cut

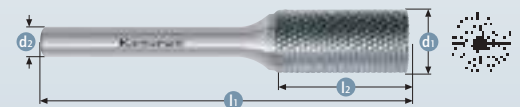
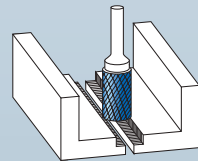

Schnittdaten  
Cutting data

Film  
Movie



Art.	d1	l2	d2	l1	gelötet brazed	VHM solid	€
11 6081 010	• 6	18	6	50		✓	22,55
11 6081 020	• 8	20	6	65	✓		27,15
11 6081 030	• 10	20	6	65	✓		31,90
11 6081 040	• 12	25	6	70	✓		39,30

Art.	d1	l2	d2	l1	gelötet brazed	VHM solid	€
11 4081 010	• 6	18	6	50		✓	20,45
11 4081 020	• 8	20	6	65	✓		25,10
11 4081 030	• 10	20	6	65	✓		28,55
11 4081 040	• 12	25	6	70	✓		34,40





11 6082



## C FORM / SHAPE WRC

Walzenrundform  
Ball nosed cylinder

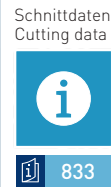
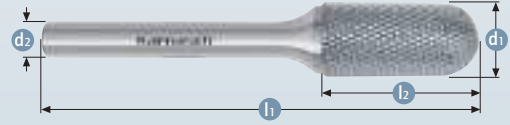
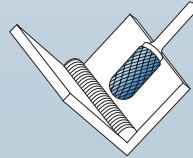

833



833

Art.	d1	l2	d2	l1	gelötet brazed	VHM solid	€
11 6082 010	• 2	11	3	38		✓	22,10
11 6082 020	• 3	14	3	38		✓	22,10
11 6082 030	• 6	12,7	3	44	✓		23,10
11 6082 040	• 6	18	6	50		✓	22,75
11 6082 050	• 8	20	6	65	✓		27,30
11 6082 060	• 10	20	6	65	✓		30,40
11 6082 070	• 12	25	6	70	✓		41,15

Art.	d1	l2	d2	l1	gelötet brazed	VHM solid	€
11 4082 010	• 2	11	3	38		✓	20,05
11 4082 020	• 3	14	3	38		✓	20,05
11 4082 030	• 6	12,7	3	44	✓		21,05
11 4082 040	• 6	18	6	50		✓	20,65
11 4082 050	• 8	20	6	65	✓		25,25
11 4082 060	• 10	20	6	65	✓		27,00
11 4082 070	• 12	25	6	70	✓		36,25

11 6083



## D FORM / SHAPE KUD

Kugel  
Ball

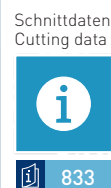
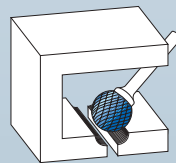

833

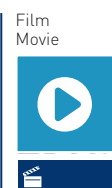

833

Art.	d1	l2	d2	l1	gelötet brazed	VHM solid	€
11 6083 010	• 2	1,8	3	38		✓	18,30
11 6083 020	• 3	2,5	3	38		✓	18,30
11 6083 030	• 4	3,4	3	38		✓	19,05
11 6083 040	• 6	5	3	38	✓		19,15
11 6083 050	• 6	4,7	6	50		✓	18,85
11 6083 060	• 8	6	6	52	✓		20,00
11 6083 070	• 10	8	6	54	✓		22,30
11 6083 080	• 12	11	6	56	✓		30,85

Art.	d1	l2	d2	l1	gelötet brazed	VHM solid	€
11 4083 010	• 2	1,8	3	38		✓	16,25
11 4083 020	• 3	2,5	3	38		✓	16,25
11 4083 030	• 4	3,4	3	38		✓	16,95
11 4083 040	• 6	5	3	38	✓		17,10
11 4083 050	• 6	4,7	6	50		✓	16,75
11 4083 060	• 8	6	6	52	✓		18,30
11 4083 070	• 10	8	6	54	✓		18,95
11 4083 080	• 12	11	6	56	✓		25,95



11 6084



**F** FORM / SHAPE **RBF**



Rundbogen  
Ball nosed tree

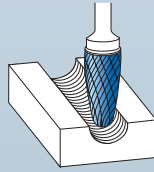

Schnittdaten  
Cutting data

Film  
Movie



Art.	d1	l2	d2	l1	gelötet brazed	VHM solid	€
11 6084 010	• 3	8	3	38		✓	22,30
11 6084 020	• 3	14	3	38		✓	22,30
11 6084 030	• 6	12	3	44	✓		23,35
11 6084 040	• 6	18	6	50		✓	21,90
11 6084 050	• 8	20	6	65	✓		28,70
11 6084 060	• 10	20	6	65	✓		32,70
11 6084 070	• 12	25	6	70	✓		40,60

Art.	d1	l2	d2	l1	gelötet brazed	VHM solid	€
11 4084 010	• 3	8	3	38		✓	20,20
11 4084 020	• 3	14	3	38		✓	20,20
11 4084 030	• 6	12	3	44	✓		21,30
11 4084 040	• 6	18	6	50		✓	19,85
11 4084 050	• 8	20	6	65	✓		26,65
11 4084 060	• 10	20	6	65	✓		29,35
11 4084 070	• 12	25	6	70	✓		35,70

11 6085



**G** FORM / SHAPE **SPG**

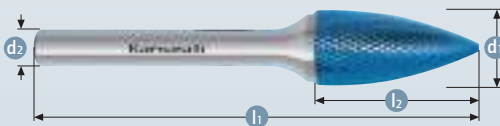

Spitzbogen  
Tree

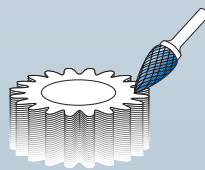

Schnittdaten  
Cutting data

Film  
Movie



Art.	d1	l2	d2	l1	gelötet brazed	VHM solid	€
11 6085 010	• 3	6	3	38		✓	22,30
11 6085 020	• 3	14	3	38		✓	22,30
11 6085 030	• 6	12	3	44	✓		23,35
11 6085 040	• 6	18	6	50		✓	24,10
11 6085 050	• 8	20	6	65	✓		25,20
11 6085 060	• 10	20	6	65	✓		28,90
11 6085 070	• 12	25	6	70	✓		36,75

Art.	d1	l2	d2	l1	gelötet brazed	VHM solid	€
11 4085 010	• 3	6	3	38		✓	20,20
11 4085 020	• 3	14	3	38		✓	20,20
11 4085 030	• 6	12	3	44	✓		21,30
11 4085 040	• 6	18	6	50		✓	22,00
11 4085 050	• 8	20	6	65	✓		23,15
11 4085 060	• 10	20	6	65	✓		25,55
11 4085 070	• 12	25	6	70	✓		31,85



# FRÄSSTIFTE / LOCHSÄGEN FÜR SCHLÜSSELDIENSTE

## ROTARY BURRS / HOLE SAWS FOR LOCKSMITHS



- 1
- 2
- 3
- 4
- 5
- 6
- 7
- 8
- 9
- 10

# 5.2

KONTAKT | CONTACT

**KARNASCH PROFESSIONAL TOOLS<sup>®</sup>**  
**INDUSTRIAL TOOLS DIVISION**

Straße des Friedens 10  
D-15848 Tauche/OT Görzdorf  
mail@karnasch.tools

**+49 (0) 33675 - 7265-0**

KARNASCH ONLINESHOP

**JETZT FÜR SIE ONLINE!**  
**NOW ONLINE FOR YOU!**

<http://shop.karnasch.tools>



ONLINE



11 5021 11 5022 11 5025



C FORM / SHAPE WRC

Walzenrundform



Ball nosed cylinder



Film  
Movie



Bestseller – preisreduziert · Bestseller – price reduced

Art.	d1	l2	d2	l1	Zahnung · Cut	€
11 5021 030	• 3,0	14	3	50	 <p><b>HP-3</b> Die am meisten verwendete Universalverzahnung Stahl bis &lt; 60 HRC The most widely used universal cutting style &lt; 60 HRC</p>	9,90
11 5021 032	• 3,0	14	3	60		10,40
11 5021 035	• 3,0	14	3	75		10,90
11 5021 040	• 3,0	14	3	100		13,70
11 5021 043	• 3,0	30*	6	60		21,70
11 5021 046	• 4,0	30*	6	60		22,25
11 5021 055	• 6,0	18	6	50		11,35
11 5021 056	• 6,0	18	6	60		15,20
11 5021 058	• 6,0	18	6	80		18,05
11 5021 060	• 6,0	18	6	100		20,40
11 5021 065	• 6,0	18	6	150	29,00	
11 5022 030	• 3,0	14	3	50	 <p><b>HP-4</b> Extra feine Kreuzverzahnung für Stähle bis ca. 70 HRC Extra fine cross cutting style up to extra hard steel 70 HRC</p>	12,25
11 5022 032	• 3,0	14	3	60		12,80
11 5022 035	• 3,0	14	3	75		13,40
11 5022 040	• 3,0	14	3	100		16,90
11 5022 043	• 3,0	30*	6	60		27,85
11 5022 046	• 4,0	30*	6	60		28,45
11 5022 055	• 6,0	18	6	50		15,40
11 5022 056	• 6,0	18	6	60		19,30
11 5022 058	• 6,0	18	6	80		23,00
11 5022 060	• 6,0	18	6	100		28,15
11 5022 065	• 6,0	18	6	150	40,00	
11 5025 055	• 6,0	18	6	50	 <p><b>HP-7</b> Grobe Zerspanung und höchster Materialabtrag bei Alulegierungen For coarse cutting and highest material removal of aluminum alloys</p>	19,40

\*11 5021 043 / 11 5022 043



\*11 5021 046 / 11 5022 046



\* Davon 15 mm verzahnt | Of which 15 mm teathed

- \* Durch Verjüngung eines Ø 6 mm Frässtiftes auf Ø 3 mm oder Ø 4 mm wird die Arbeitszeit um ca. die Hälfte reduziert, da weniger Material zerspannt werden muss.
- Durch Ø 6 mm Schaft wesentlich bruchunempfindlicher als durchgehend Ø 3 mm oder Ø 4 mm Schaft
- Bei Ø 3 mm, 4 mm, 6 mm kann mit der gleichen Ø 6 mm Spannzange gearbeitet werden.
- Die Kernziehschutzblende muss in der Regel wegen des geringen Fräskopf-Durchmessers nicht zerstört werden.

- \* By tapering of a 6 mm burr to Ø 3 mm or Ø 4 mm working time is reduced by about half, because less material needs to be machined.
- Because of its 6 mm shank, significantly less susceptible to breakage than continuous Ø 3 mm or Ø 4 mm shank
- At Ø 3 mm, Ø 4 mm the same collet can be used for Ø 6 mm
- Because of the limited diameter of the burr head, the core drawing tray may not be disturbed

11 3021

11 3022

11 3025



C FORM / SHAPE

WRC

Walzenrundform

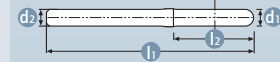

Ball nosed cylinder



Film  
Movie

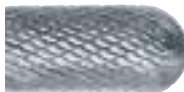

Bestseller – preisreduziert · Bestseller – price reduced

Art.	d1	l2	d2	l1	Zahnung · Cut	€
11 3021 030	• 3,0	14	3	50	 <p><b>HP-3</b> Die am meisten verwendete Universalverzahnung Stahl bis &lt; 60 HRC</p> <p>The most widely used universal cutting style &lt; 60 HRC</p> <p><b>BEST SELLER</b></p> <p>Schnittdaten Cutting data</p> <p><b>i</b></p> <p>753</p>	8,10
11 3021 032	• 3,0	14	3	60		8,60
11 3021 035	• 3,0	14	3	75		9,15
11 3021 040	• 3,0	14	3	100		11,90
11 3021 043	• 3,0	30*	6	60		19,95
11 3021 046	• 4,0	30*	6	60		20,50
11 3021 055	• 6,0	18	6	50		9,60
11 3021 056	• 6,0	18	6	60		13,40
11 3021 058	• 6,0	18	6	80		16,30
11 3021 060	• 6,0	18	6	100		18,65
11 3021 065	• 6,0	18	6	150	26,20	
11 3022 032	• 3,0	14	3	60	 <p><b>HP-4</b> Extra feine Kreuzverzahnung für Stähle bis ca. 70 HRC</p> <p>Extra fine cross cutting style up to extra hard steel 70 HRC</p> <p>Schnittdaten Cutting data</p> <p><b>i</b></p> <p>817</p>	10,75
11 3022 040	• 3,0	14	3	100		14,85
11 3022 043	• 3,0	30*	6	60		25,75
11 3022 046	• 4,0	30*	6	60		26,40
11 3022 055	• 6,0	18	6	50		13,35
11 3022 056	• 6,0	18	6	60		17,20
11 3022 058	• 6,0	18	6	80		20,95
11 3022 060	• 6,0	18	6	100		26,05
11 3025 055	• 6,0	18	6	50	 <p><b>HP-7</b> Grobe Zerspantung und höchster Materialabtrag bei Alulegierungen</p> <p>For coarse cutting and highest material removal of aluminum alloys</p> <p>Schnittdaten Cutting data</p> <p><b>i</b></p> <p>785</p>	14,55

\* 11 3021 043 / 11 3022 043

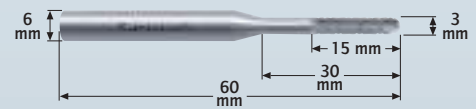

\* 11 3021 046 / 11 3022 046



\* Davon 15 mm verzahnt | Of which 15 mm teathed

- \* Durch Verjüngung eines Ø 6 mm Frässtiftes auf Ø 3 mm oder Ø 4 mm wird die Arbeitszeit um ca. die Hälfte reduziert, da weniger Material zerspant werden muss.
- Durch Ø 6 mm Schaft wesentlich bruchunempfindlicher als durchgehend Ø 3 mm oder Ø 4 mm Schaft
- Bei Ø 3 mm, 4 mm, 6 mm kann mit der gleichen Ø 6 mm Spannzange gearbeitet werden.
- Die Kernziehschutzblende muss in der Regel wegen des geringen Fräskopf-Durchmessers nicht zerstört werden.

- \* By tapering of a 6 mm burr to Ø 3 mm or Ø 4 mm working time is reduced by about half, because less material needs to be machined.
- Because of its 6 mm shank, significantly less susceptible to breakage than continuous Ø 3 mm or Ø 4 mm shank
- At Ø 3 mm, Ø 4 mm, the same collet can be used for Ø 6 mm
- Because of the limited diameter of the burr head, the core drawing tray may usually not be disturbed



11 4701

€ 32,40

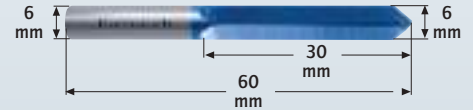

Schnittdaten  
Cutting data



Film  
Movie



**Vollhartmetall-Bohrfräser der neuesten Generation.** Öffnet Schließzylinder in Rekordzeit. Beste Ergebnisse werden mit Geradschleifer erzielt (siehe Seite 1178/1179). Aufbohrungen sind mit Bohrmaschinen/Akku-Bohrmaschinen möglich.

In Verbindung mit Frässtiften (Seite 838) ergibt sich die ideale Werkzeugkombination.

Mit dem Bohrfräser wird der Zylinder in kürzester Zeit geradlinig aufgebohrt. In der Regel sollte der Schließzylinder nun bereits zu schließen sein. Falls nicht, z.B. bei besonderen Bohrschutzsicherungen, wird die Bohrung mit einem Frässtift (siehe Seite 839) seitlich erweitert.

**Solid carbide drill of the newest generation.** Opens locking cylinders in record time. Best results are achieved with straight grinders (see page 1178/1179). Also drilling with drilling/battery drills. Together with burrs (page 838), the ideal tool combination is achieved. With the drill, the cylinder is drilled in a straight line in the shortest possible time. Usually, the locking cylinder can already be closed now. If not, e.g., in case of special drill prevention, the borehole is sideways expanded with a burr (see page 839).

6 11 4702

€ 17,15



## HM-LOCHSÄGE FÜR ABLOY PROTEC-SCHLISSZYLINDER T.C.T. HOLESAWS FOR ABLOY PROTEC LOCKING CYLINDERS

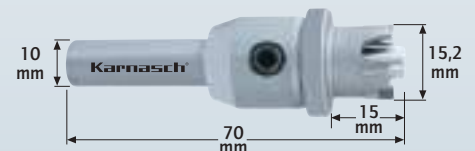

Schnittdaten  
Cutting data



Film  
Movie



Zu verwenden mit einer Bohrmaschine/starke Akku-Bohrmaschine. Mit dieser Lochsäge ist es möglich, die vor dem Kern liegende, gehärtete Stirnplatte dieses speziellen Hochsicherheitszylinders zu durchdringen um anschließend den Kern herausziehen zu können.

Werkzeugmerkmale:

- 4 x HM-Zähne Ø 15,2
- Gefederte Stiftführung (6,8 mm) zur Zentrierung im Schließkanal
- Tiefenanschlag

To be used with a drilling machine/strong battery drill. With this holesaw it is possible to penetrate the hardened front plate of this special high security locking cylinder that sits in front of the core and then to retrieve the core.

Properties of the tool:

- 4 x T.C.T. teeth Ø 15.2
- Sprung pin guide (6.8 mm) for centring in the locking channel
- Depth stop

# SPEZIAL FRÄSSTIFTE

# SPECIAL BURRS



- 1
- 2
- 3
- 4
- 5
- 6
- 7
- 8
- 9
- 10

# 5.3

KONTAKT | CONTACT

**KARNASCH PROFESSIONAL TOOLS<sup>®</sup>**  
**INDUSTRIAL TOOLS DIVISION**

Straße des Friedens 10  
D-15848 Tauche/OT Görzdorf  
mail@karnasch.tools

**+49 (0) 33675 - 7265-0**

KARNASCH ONLINESHOP

**JETZT FÜR SIE ONLINE!**  
**NOW ONLINE FOR YOU!**

<http://shop.karnasch.tools>



ONLINE



- 1
- 2
- 3
- 4
- 5
- 6
- 7
- 8
- 9
- 10



Frässtifte für GFK/CFK  
Fiberglass routers

843

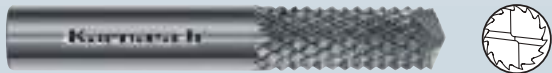
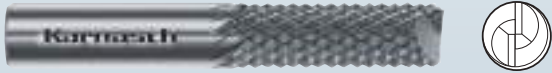

Mini-Frässtifte Ø 1 + 1,5 mm  
Mini-burrs Ø 1 + 1,5 mm

844



Frässtifte + Bohrer für Schlüsseldienste  
Burrs + drills for locksmiths

838-840

11 6011



HP-2 VERZÄHNUNG · CUT

11 4011

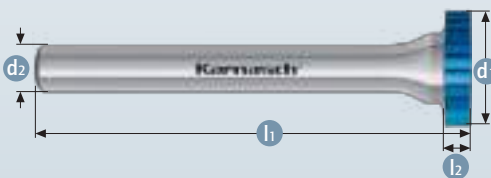

Scheibenform

RIM shape

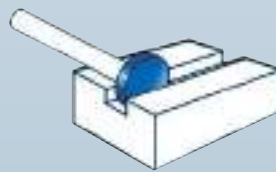

Schnittdaten  
Cutting data

1395

Film  
Movie

Art.	d1	l2	d2	l1	gelötet brazed	Form Shape	€
11 6011 005	• 10	1,6	3	34	✓		17,30
11 6011 010	• 12	2,6	6	48	✓		42,30
11 6011 015	• 25	5,2	8	50	✓		100,15
11 6011 020	• 25	6,3	8	51	✓		103,95

Art.	d1	l2	d2	l1	gelötet brazed	Form Shape	€
11 4011 005	• 10	1,6	3	34	✓		13,95
11 4011 010	• 12	2,6	6	48	✓		37,40
11 4011 015	• 25	5,2	8	50	✓		93,75
11 4011 020	• 25	6,3	8	51	✓		97,55



11 6001

11 6002

11 6003

11 6004

**GFK, CFK**

Für Kunststoffe, GFK, CFK, MMC

Routers for fiberglass, GFK, CFK

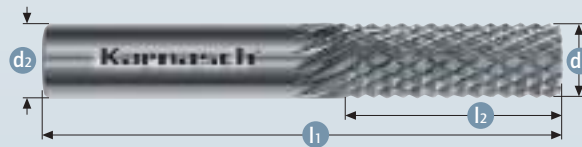

Toleranzen  
Tolerances

- d1  
Ø 1.6 mm, 2.4 mm = +0,00/-0,10  
Ø 3-12 mm = +0,00/-0,13

Schnittdaten  
Cutting data

Film  
Movie

1336

Diese Frässtifte sind geeignet zum Umrissfräsen, Besäumen, Nuten und Bohren der großen Bandbreite von Faserverstärkten Kunststoffen (Fiberglas, GFK CFK). Weiterhin für MMC, Metal Matrix Composites = schwer zerspanbare abrasive Verbundstoffe wie z.B. Leiterplatten, Verbindungen wie Keramik mit Glasfaser, Graphit, Carbon.

These routers are for contouring, grooving, drilling of a wide range of GFK, CFK, fiberglass reinforced plastics, as well as MMC (Metal Matrix Composites). MMC material such as printed circuit boards, composites such as ceramic with glass fiber, graphite, carbon etc.

Sollten höchste Standzeiten erwünscht sein, empfehlen wir eine Diamantbeschichtung. Auf Anfrage.

If highest lifetime is required do we recommend a diamond coating. On request.

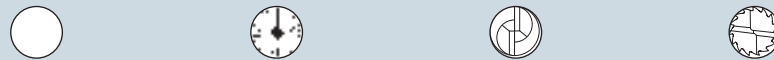

 Ohne Stirnverzahnung No end cut	 Mehrschneiden Stirnverzahnung Burr end cut	 Zweischneiden Stirnverzahnung 2-flute end mill cut	 Bohrspitze 135° Drill point 135°
--	--	--	---

d1	l2	d2	l1	VHM solid	11 6001		11 6002		11 6003		11 6004	
					Art.	€	Art.	€	Art.	€	Art.	€
• 1,6	5	3	38	✓	% 11 6001 001	5,20	11 6002 001	11,50	11 6003 001	11,55	11 6004 001	12,30
• 2,4	9,5	3	38	✓	% 11 6001 003	5,50	11 6002 003	11,50	11 6003 003	12,50	% 11 6004 003	7,20
• 3	12	3	38	✓	11 6001 005	11,00	11 6002 005	11,60	11 6003 005	13,65	11 6004 005	13,65
• 4	16	4	50	✓	% 11 6001 010	8,30	11 6002 010	16,40	11 6003 010	18,35	11 6004 010	18,35
• 4	16	6	50	✓	% 11 6001 012	9,35	11 6002 012	19,65	11 6003 012	20,95	11 6004 012	21,80
• 6	19	6	50	✓	11 6001 013	17,55	11 6002 013	19,65	11 6003 013	20,95	11 6004 013	21,80
• 6	19	6	63	✓	11 6001 015	26,05	11 6002 015	27,45	11 6003 015	29,20	11 6004 015	29,20
• 6	25	6	75	✓	11 6001 017	21,80	11 6002 017	23,70	11 6003 017	24,85	11 6004 017	25,65
• 8	25	8	63	✓	11 6001 020	36,15	11 6002 020	38,15	11 6003 020	39,80	11 6004 020	39,80
○ 10	25	10	63	✓	% 11 6001 025	25,05	-	-	-	-	-	-
• 10	25	10	75	✓	11 6001 027	45,45	11 6002 027	49,40	11 6003 027	51,30	11 6004 027	53,30
• 12	25	12	75	✓	11 6001 029	62,40	11 6002 029	68,65	11 6003 029	72,00	11 6004 029	75,30
○ 12	30	12	75	✓	% 11 6001 030	35,80	-	-	-	-	-	-

Schnittgeschwindigkeit • Cutting speed (m/min)		
	450	900
Ø (mm)	Drehzahlen (min <sup>-1</sup> ) • Rotational speed (rpm)	
2	72.000	143.000
3	48.000	95.000
4	36.000	72.000
6	24.000	48.000
8	17.000	36.000
10	14.000	29.000
12	12.000	24.000

% Sonderpreis / Sale Artikel. Lieferbar solange Vorrat.  
Special price / sale article. While stocks last.



**MINI-UNI**

**Einsatzgebiete:** Feinmechanik, Schmuckindustrie, Turbinenbau, Werkzeugbau  
**Zu bearbeitende Werkstoffe:** Edelstähle, Buntmetalle, Zinkdruckguss, weiche Keramiken, Titanlegierungen  
**Drehzahlempfehlung:** ca. 70.000 U/min

**Applications:** Precision engineering, jewellery industry, turbine manufacture, tool manufacture  
**For use on:** stainless steel, copper and copper alloys, zinc pressure die castings soft ceramics, titanium alloys  
**Recommended operating speed:** +/- 70,000 RPM



Art.	d1	l2	d2	l1	Form Shape	DIN 8033	€
11 5006 005	• 1	4	3	38	A	ZYA	13,00
11 5006 010	• 1,5	4	3	38	A	ZYA	13,00
11 5006 020	• 2	4	3	38	A	ZYA	13,00
11 5026 005	• 1	4	3	38	C	WRC	13,00
11 5026 010	• 1,5	4	3	38	C	WRC	13,00
11 5026 015	• 2	4	3	38	C	WRC	13,00
11 5036 005	• 1	1	3	38	D	KUD	13,00
11 5036 010	• 1,5	1	3	38	D	KUD	13,00
11 5036 015	• 2	2	3	38	D	KUD	13,00
11 5046 005	• 1,5	4	3	38	E	TRE	13,00
11 5056 005	• 1,5	4	3	38	F	RBF	13,00
11 5066 005	• 1,5	4	3	38	G	SPG	13,00
11 5196 005	• 1,5	4	3	38	M	SKM	13,00

Art.	d1	l2	d2	l1	Form Shape	DIN 8033	€
11 3006 005	• 1	4	3	38	A	ZYA	10,90
11 3006 010	• 1,5	4	3	38	A	ZYA	10,90
11 3006 020	• 2	4	3	38	A	ZYA	10,90
11 3026 005	• 1	4	3	38	C	WRC	10,90
11 3026 010	• 1,5	4	3	38	C	WRC	10,90
11 3026 015	• 2	4	3	38	C	WRC	10,90
11 3036 005	• 1	1	3	38	D	KUD	10,90
11 3036 010	• 1,5	1	3	38	D	KUD	10,90
11 3036 015	• 2	2	3	38	D	KUD	10,90
11 3046 005	• 1,5	4	3	38	E	TRE	10,90
11 3056 005	• 1,5	4	3	38	F	RBF	10,90
11 3066 005	• 1,5	4	3	38	G	SPG	10,90
11 3196 005	• 1,5	4	3	38	M	SKM	10,90

	COMBI		CURVE		
ZYA					848
ZYB					849
WRC					850
WRC					851
RBF					852
SKM					853
KEL					854
KSJ					855
KSK					856

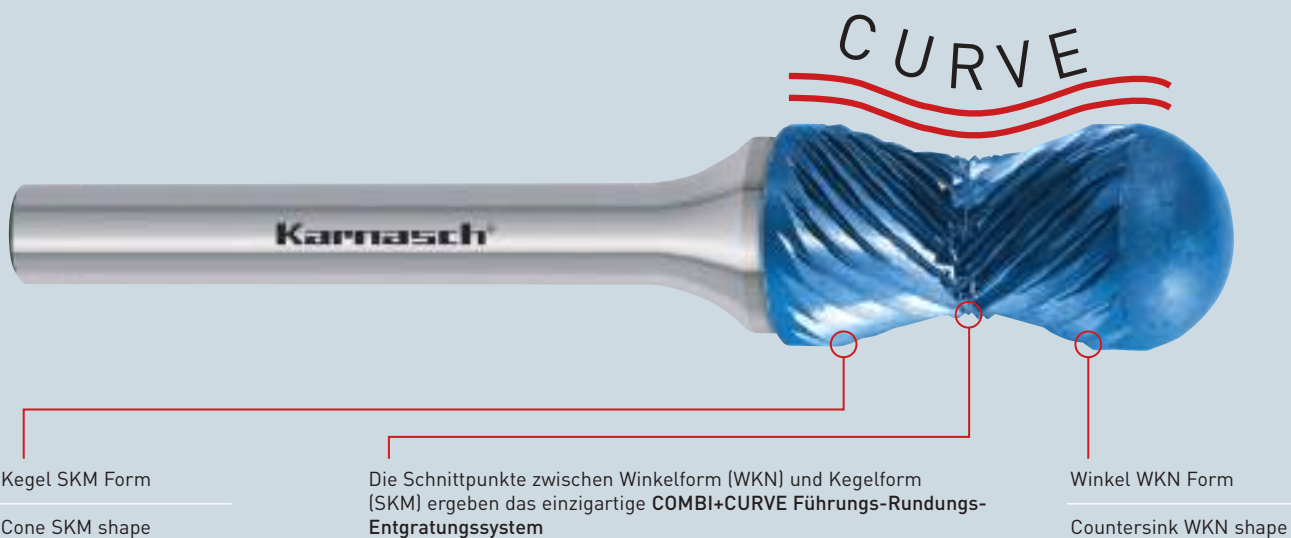

Kegel SKM Form  
Cone SKM shape

Die Schnittpunkte zwischen Winkelform (WKN) und Kegelform (SKM) ergeben das einzigartige COMBI+CURVE Führungs-Rundungs-Entgratungssystem

The intersecting points of the countersink (WKN) and cone shapes (SKM) form the unique COMBI+CURVE guiding-rounding-deburring system

Winkel WKN Form  
Countersink WKN shape

1



2



3



4



5



6



7



8



9



10

Index



	COMBI		CURVE	
ZYA				848
ZYB				849
WRC				850
WRC				851
RBF				852
SKM				853
KEL				854
KSJ				855
KSK				856

Die Kombination aus den gängigsten Kopfformen wie Zylinder ZYA + ZYB, Walzenrund WRC, Rundbogen RBF, Spitzbogen SPG, Rundkegel KEL, Winkel KSJ + KSK mit dem einzigartigen **COMBI+CURVE Führungs-Rundungs-Entgratungssystem** ergeben folgende Vorteile:

- Ideal zum schnellen Kantenverrunden.
- Die Kanten werden nicht einfach flach abgeschrägt, sondern erhalten durch das einzigartige **Führungs-Rundungs-Entgratungssystem** eine saubere Rundung.
- Der **COMBI+CURVE** zentriert sich selbst, immer mittig zur Kante.
- Durch die einzigartige Selbstzentrierung ist ein Abgleiten oder Ver-rutschen an scharfen Kanten nahezu unmöglich.
- Somit besteht eine deutlich bessere Kontrolle und garantiert einen einfachen und schnellen Materialabtrag.

Anwendbar in den verschiedensten Materialien wie: Gusseisen, Stahl < 60 HRC, Edelstahl (INOX), Nickelbasis- und Titanlegierungen, sowie Kupfer, Messing und Bronze

The combination of the most used head shapes as cylinder ZYA + ZYB, ball nosed cylinder WRC, ball nosed tree RBF, tree SPG, ball nosed cone KEL, countersink KSJ + KSK with the unique **COMBI+CURVE guiding-rounding-deburring system** result in the following advantages:

- The ideal tool for extremely fast chamfering. The edges are not simply bevelled, but by the unique guiding-rounding-deburring system smoothly rounded.
- **COMBI+CURVE guiding-rounding-deburring system** always centres itself on the centre of the edge.
- Slipping off the edge is almost impossible. This gives best control and guarantees faster and easier removal of material.

Can be used on a wide variety of material e.g. cast iron, steel < 60 HRC, stainless steel (INOX), nickel-based and titanium alloys, copper, brass and bronze.

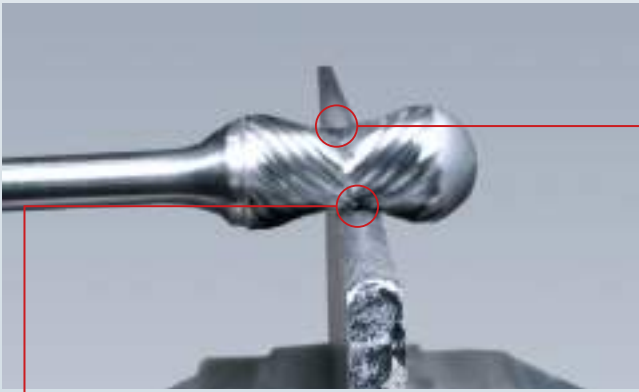

Außenradius  
External radius

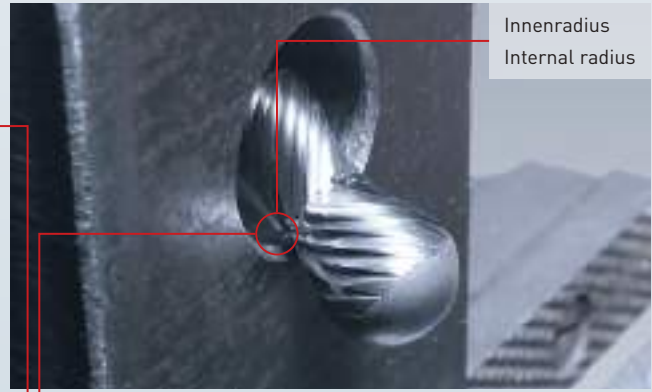

Innenradius  
Internal radius

Die Schnittpunkte zwischen Winkelform (WKN) und Kegelform (SKM) ergeben das einzigartige COMBI+CURVE Führungs-Rundungs-Entgratungssystem

The intersecting points of the countersink (WKN) and cone shapes (SKM) form the unique COMBI+CURVE guiding-rounding-deburring system



Interne Fase in SKM Form  
Internal chamfer with SKM shape



Außenfase in SKM Form  
External chamfer with SKM shape



Interne Fase in WKN Form  
Internal chamfer with WKN shape



Außenfase in WKN Form  
External chamfer with WKN shape

- 1
- 2
- 3
- 4
- 5
- 6
- 7
- 8
- 9
- 10

11 6019



11 4019

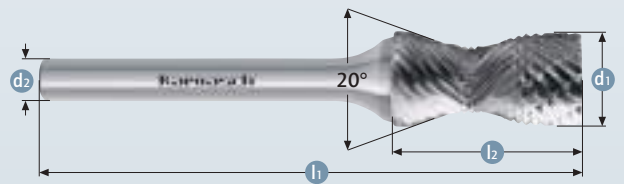
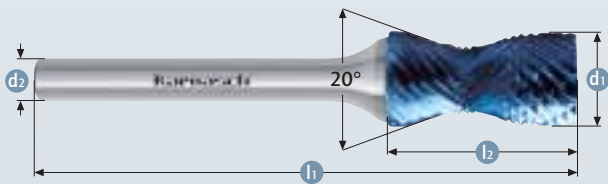

Curve + Zylinder

Curve + Cylinder

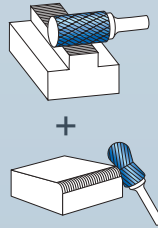

Schnittdaten  
Cutting data

Film  
Movie



Art.	d1	l2	d2	l1	gelötet brazed	VHM solid	€
11 6019 100	• 12	25	6	70	✓	-	45,95

Art.	d1	l2	d2	l1	gelötet brazed	VHM solid	€
11 4019 100	• 12	25	6	70	✓	-	41,05

### Anwendungsbeispiele / Application examples

COMBI →



+

CURVE



- 1
- 2
- 3
- 4
- 5
- 6
- 7
- 8
- 9
- 10

11 6020



11 4020

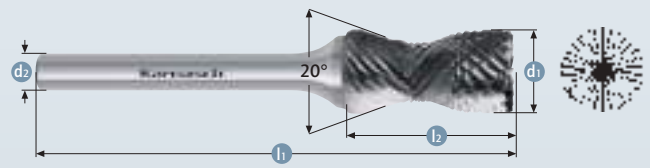
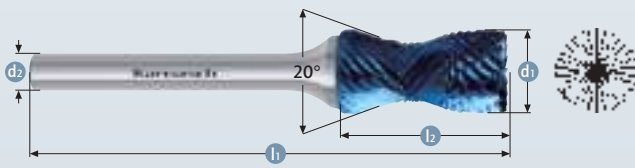

Curve + Zylinder mit Stirnverzahnung

Curve + Cylinder with end cut

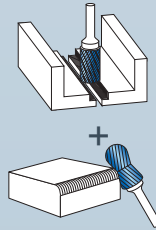

Schnittdaten  
Cutting data

Film  
Movie



753

Art.	d1	l2	d2	l1	gelötet brazed	VHM solid	€
11 6020 100	• 12	25	6	70	✓	-	58,05

Art.	d1	l2	d2	l1	gelötet brazed	VHM solid	€
11 4020 100	• 12	25	6	70	✓	-	53,10

## Anwendungsbeispiele / Application examples

COMBI →

+

CURVE



1



2



3



4



5



6



7



8



9



10



Index

11 6021



11 4021

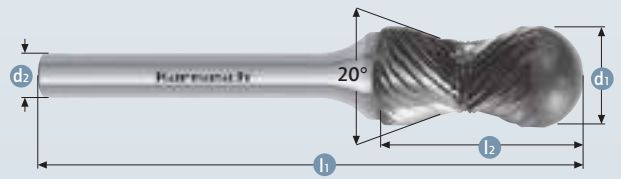
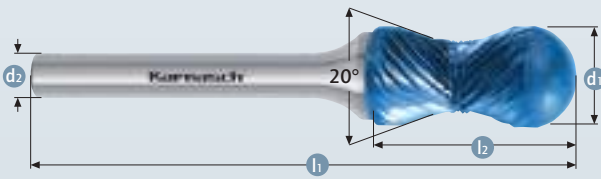

Curve + Walzenrundform

Curve + Ball nosed cylinder

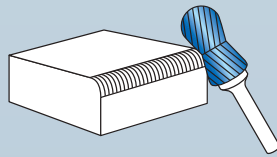

Schnittdaten  
Cutting data

Film  
Movie



Art.	d1	l2	d2	l1	gelötet brazed	VHM solid	€
11 6021 100	• 12	25	6	70	✓	-	50,95

Art.	d1	l2	d2	l1	gelötet brazed	VHM solid	€
11 4021 100	• 12	25	6	70	✓	-	46,05

## Anwendungsbeispiele / Application examples

COMBI →



CURVE



Der Radius an der Spitze des Frässtifts dient als Führung und Abstützung. Beschädigungen am Werkstück werden vermieden.

The radius at the front of the burr serves as a guide and a support. Damage to the workpiece can thus be avoided.





11 6022



11 4022

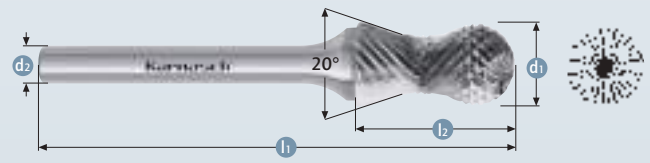
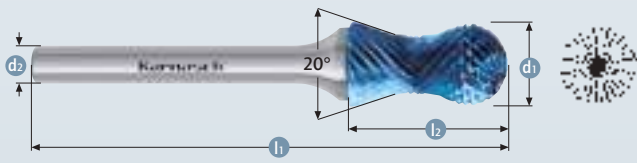

Curve + Walzenrundform

Curve + Ball nosed cylinder

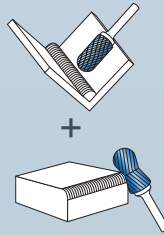

Schnittdaten Cutting data	Film Movie
753	

Art.	d1	l2	d2	l1	gelötet brazed	VHM solid	€
11 6022 100	• 12	25	6	70	✓	-	50,95

Art.	d1	l2	d2	l1	gelötet brazed	VHM solid	€
11 4022 100	• 12	25	6	70	✓	-	46,05

## Anwendungsbeispiele / Application examples

COMBI →



CURVE ↓



- 1
- 2
- 3
- 4
- 5
- 6
- 7
- 8
- 9
- 10

11 6023



11 4023

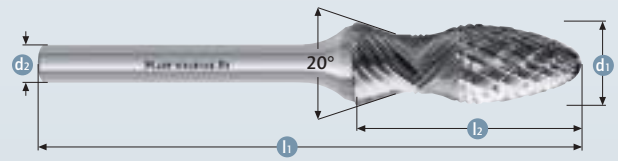
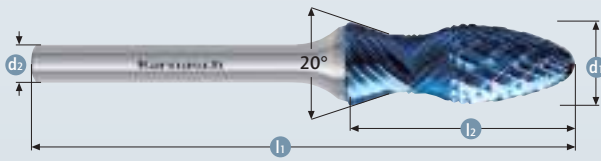

Curve + Rundbogen

Curve + Ball nosed tree

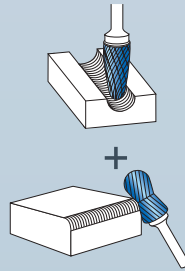

Schnittdaten  
Cutting data

Film  
Movie



Art.	d1	l2	d2	l1	gelötet brazed	VHM solid	€
11 6023 100	• 12	35	6	80	✓	-	59,75

Art.	d1	l2	d2	l1	gelötet brazed	VHM solid	€
11 4023 100	• 12	35	6	80	✓	-	54,85

### Anwendungsbeispiele / Application examples

COMBI →



CURVE



- 1
- 2
- 3
- 4
- 5
- 6
- 7
- 8
- 9
- 10

11 6024



11 4024

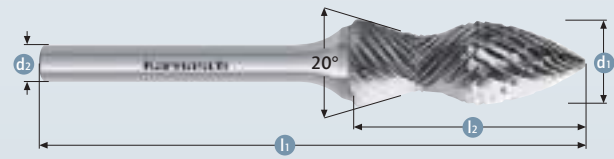
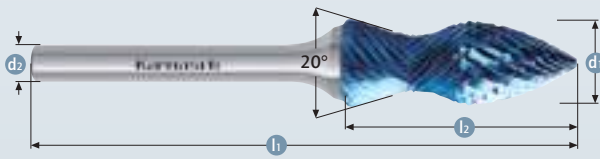

Curve + Spitzbogen

Curve + Tree

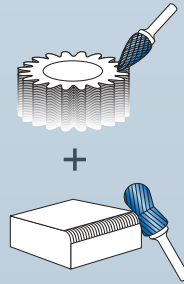

Schnittdaten  
Cutting data

Film  
Movie



753

Art.	d1	L2	d2	L1	gelötet brazed	VHM solid	€
11 6024 100	• 12	35	6	80	✓	-	46,50

Art.	d1	L2	d2	L1	gelötet brazed	VHM solid	€
11 4024 100	• 12	35	6	80	✓	-	41,60

## Anwendungsbeispiele / Application examples

COMBI →

+

CURVE



1



2



3



4



5



6



7



8



9



10



11 6025



11 4025

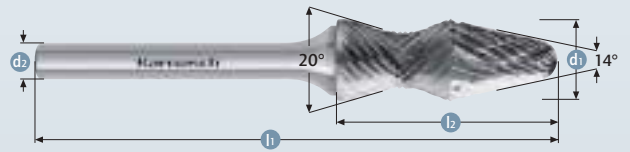
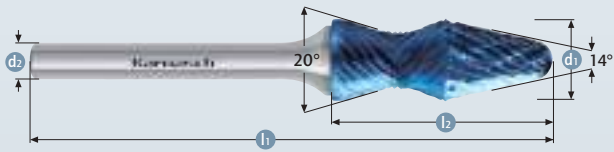

Curve + Rundkegel

Curve + Ball nosed cone

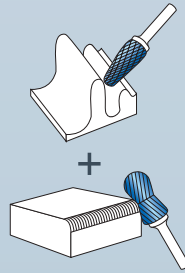

Schnittdaten  
Cutting data

Film  
Movie



Art.	d1	l2	d2	l1	gelötet brazed	VHM solid	€
11 6025 100	• 12	35	6	80	✓	-	49,70

Art.	d1	l2	d2	l1	gelötet brazed	VHM solid	€
11 4025 100	• 12	35	6	80	✓	-	44,75

### Anwendungsbeispiele / Application examples

COMBI →



CURVE



- 1
- 2
- 3
- 4
- 5
- 6
- 7
- 8
- 9
- 10

Index

11 6026



11 4026

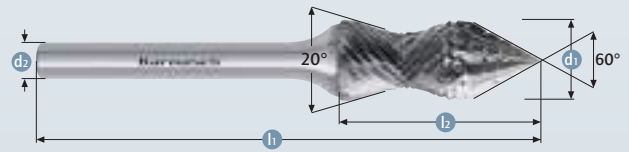
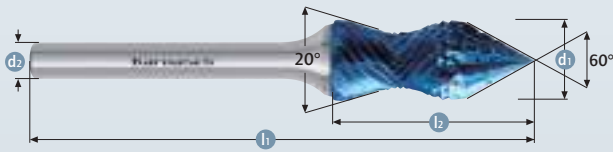

Curve + Kegel 60°

Curve + Countersink 60°

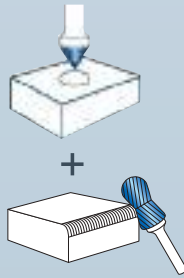

Schnittdaten Cutting data	Film Movie
753	

Art.	d1	l2	d2	l1	gelötet brazed	VHM solid	€
11 6026 100	• 12	28	6	73	✓	-	46,05

Art.	d1	l2	d2	l1	gelötet brazed	VHM solid	€
11 4026 100	• 12	28	6	73	✓	-	41,15

## Anwendungsbeispiele / Application examples

COMBI →



CURVE ↓



- 1
- 2
- 3
- 4
- 5
- 6
- 7
- 8
- 9
- 10

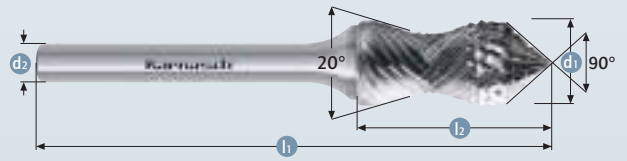
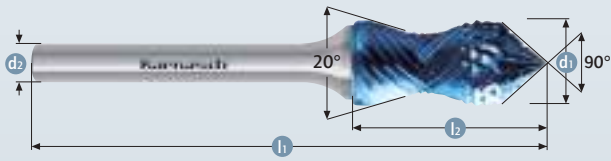

Curve + Kegel 90°

Curve + Countersink 90°

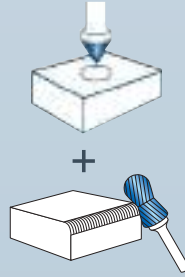

Schnittdaten  
Cutting data

Film  
Movie



Art.	d1	l2	d2	l1	gelötet brazed	VHM solid	€
11 6027 100	• 12	31	6	76	✓	-	46,05

Art.	d1	l2	d2	l1	gelötet brazed	VHM solid	€
11 4027 100	• 12	31	6	76	✓	-	41,15

## Anwendungsbeispiele / Application examples

COMBI →



CURVE



- 1
- 2
- 3
- 4
- 5
- 6
- 7
- 8
- 9
- 10

# KARNASCH PROFESSIONAL TOOLS WORLDWIDE

The rapid progress of technology always poses new challenges to companies from the metal-processing industry. It is more important for these companies to have future-oriented and reliable partner by their side who will not settle for targets achieved but provides impulses for new developments.

KARNASCH Professional Tools has offered an innovative and diverse product range and professional service towards its customers for more than 50 countries. The amount of know-how in our products becomes evident in daily use. Equipped with an extraordinary performance capacity, our products convince customers from all industries and around the world. Our past distinction will continue into the future with ever-new product innovations as well. You may continue to count on our excellent service.

## KARNASCH – Made for Professionals



**EUROPE** AUSTRIA · BELGIUM · BOSNIA HERZEGOVINA · BRITISH VIRGIN ISLANDS · BULGARIA · CROATIA · CYPRUS · CZECH REPUBLIC · DENMARK · ESTONIA · FAROE ISLANDS · FINLAND · FRANCE · GEORGIA · GERMANY · GREECE · HUNGARY · ICELAND · IRELAND · ITALY · KOSOVO · LATVIA · LITHUANIA · LUXEMBOURG · MALTA · MOLDOVA · MONACO · MONTENEGRO · NETHERLANDS · NORWAY · POLAND · PORTUGAL · REPUBLIC OF MOLDOVA · REPUBLIC OF MACEDONIA · ROMANIA · RUSSIA · SAN MARINO · SLOVAKIA · SLOVENIA · SPAIN · SWEDEN · SWITZERLAND · TURKEY · UKRAINE · UNITED KINGDOM · WHITE RUSSIA/BELARUS · **AFRICA** ANGOLA · EGYPT · EQUATORIAL GUINEA · LYBIA · MOROCCO · NIGERIA · REPUBLIC OF MAURITIUS · SAUDI ARABIA · SOUTH AFRICA · UAE/UNITED ARAB EMIRATES · **ASIA** ARMENIA · AZERBAIJAN · CHINA · SOUTH KOREA · GEORGIA · HONG KONG · INDIA · INDONESIA · ISRAEL · JAPAN · JORDAN · KAZAKHSTAN · KUWAIT · LEBANON · MALAYSIA · PHILIPPINES · QATAR · SINGAPORE · TAIWAN · THAILAND · TUNESIEN REPUBLIC · VIETNAM · **SOUTH AMERICA** ARGENTINIA · BRAZIL · CHILE · COLOMBIA · EQUADOR · PERU · **AMERICA** AMERICAN SAMOA · CANADA · USA · **MIDDLE AMERICA** COSTA RICA · EL SALVADOR · MEXICO · **AUSTRALIA** · **OCEANIA** CALEDONIA · NEW ZEALAND

1



2



3



4



5



6



7



8



9



10

Index

- 1
- 2
- 3
- 4
- 5
- 6
- 7
- 8
- 9
- 10

COMBI		FORM					
ZYA	+ WKN				Zylinder ohne Stirnverzahnung + Winkel	Cylinder without end cut + inverted cone	860
ZYB	+ WKN				Zylinder mit Stirnverzahnung + Winkel	Cylinder with end cut + inverted cone	860
WRC	+ WKN				Walzenrundform + Winkel	Ball nosed cylinder + inverted cone	861
WKN	+ WKN				Winkel + Winkel	Inverted cone + inverted cone	861
KSJ	+ ZYA				Kegel 60° + Zylinder	Countersink 60° + cylinder	862

### Anwendungsbeispiele / Application examples













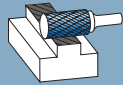

### PRODUKTBESCHREIBUNG:

Die neuen COMBI+FORM Frässtifte bieten ein Maß an noch nie zuvor gesehener Vielseitigkeit.

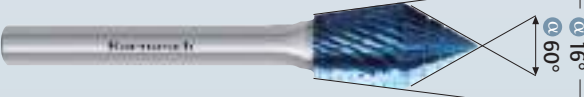
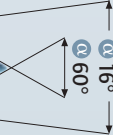
COMBI+FORM Frässtifte sind hervorragend geeignet zum Nachbearbeiten vom komplexen Werkstücken. Durch die Zusammenführung von verschiedenen Formen, werden Rüstkosten minimiert. Zeitaufwendige Werkzeugwechsel, Kauf weiterer Formen wird vermieden. Entgraten, Kanten-, sowie verschiedenartigste Multifunktionsarbeiten sind mit nur einem Werkzeug möglich.

Die COMBI+FORM Frässtifte sind geeignet für eine Vielzahl von Metallen und Stahlsorten wie: Gusseisen, Stahl <60 HRC, Edelstahl (INOX), Nickelbasis- und Titanlegierungen, Kupfer, Messing und Bronze



COMBI		FORM				
KSK 	+ ZYA 			Kegel 90° + Zylinder	Countersink 90° + cylinder	 862
KSJ 	+ WKN 			Kegel 60° + Winkel	Countersink 60° + inverted cone	 863
- 	- 			Kegel + Kegel	Countersink + Countersink	 864

## Anwendungsbeispiele / Application examples



### PRODUCT DESCRIPTION:

COMBI+FORM versatility to suit almost any application

Just like any multi-tool in the DIY sector, there is now high performance multipurpose burrs for the industry. The COMBI+FORM line has been developed to reduce downtime and cover multi-application processes for metal removal. These exclusive new shapes will cover your deburring, edging and blending work in one simple burr solution. This range is ideal for complex parts where different shapes are required. The COMBI+FORM will maximise your productivity.

#### Features and benefits

- Reduced downtime for end user
- Special tooth geometry manufactured using the latest CNC machines
- The highest quality sintered tungsten carbide is used to ensure consistent performance
- A versatile burr to be used on a wide range of materials and processes

Can be used on a wide variety of material e.g. cast iron, steel <60 HRC, stainless steel (INOX), nickel-based and titanium alloys, copper, brass and bronze

1



2



3



4



5



6



7



8



9



10



11 6051



FORM / SHAPE

ZYA / WKN

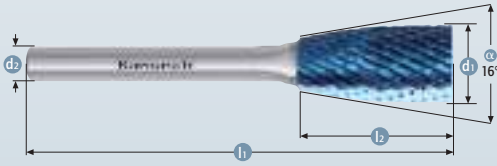

Zylinder ohne Stirnverzahnung + Winkel

Cylinder without end cut + inverted cone

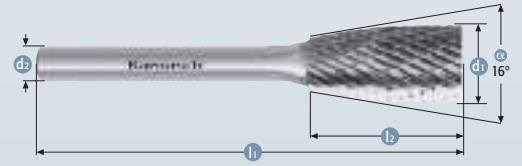
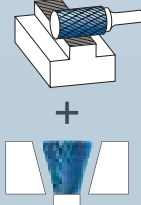

Schnittdaten  
Cutting data

Film  
Movie



Art.	d1	l2	d2	l1	gelötet brazed	VHM solid	€
11 6051 100	12	25	6	70			24,45

Art.	d1	l2	d2	l1	gelötet brazed	VHM solid	€
11 4051 100	12	25	6	70			21,85

Anwendungsbeispiele  
Application examples



11 6052



FORM / SHAPE

ZYB / WKN

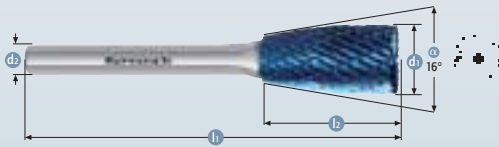

Zylinder mit Stirnverzahnung + Winkel

Cylinder with end cut + inverted cone

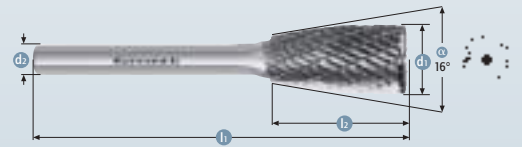
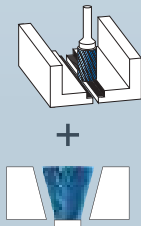

Schnittdaten  
Cutting data

Film  
Movie



Art.	d1	l2	d2	l1	gelötet brazed	VHM solid	€
11 6052 100	12	25	6	70			26,65

Art.	d1	l2	d2	l1	gelötet brazed	VHM solid	€
11 4052 100	12	25	6	70			24,05

Anwendungsbeispiele  
Application examples



- 1
- 2
- 3
- 4
- 5
- 6
- 7
- 8
- 9
- 10

11 6053

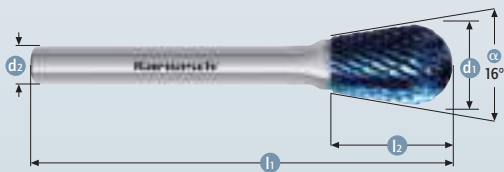

FORM / SHAPE

WRC/  
WKN

Walzenrundform + Winkel

Ball nosed cylinder + inverted cone

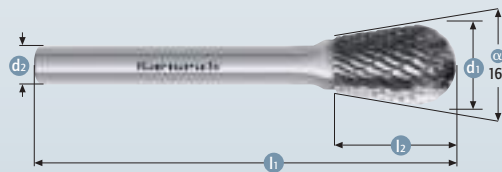
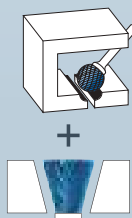

Schnittdaten  
Cutting data



753

Film  
Movie



753

Art.	d1	l2	d2	l1	gelötet brazed	VHM solid	€
11 6053 100	12	20	6	65			19,85

Art.	d1	l2	d2	l1	gelötet brazed	VHM solid	€
11 4053 100	12	20	6	65			17,30

Anwendungsbeispiele  
Application examples



11 6058

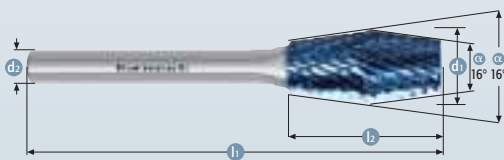

FORM / SHAPE

WKN/  
WKN

Winkel + Winkel

Inverted cone + inverted cone

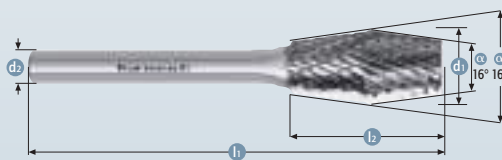

Schnittdaten  
Cutting data



753

Film  
Movie



753

Art.	d1	l2	d2	l1	gelötet brazed	VHM solid	€
11 6058 100	12	25	6	70			31,30

Art.	d1	l2	d2	l1	gelötet brazed	VHM solid	€
11 4058 100	12	25	6	70			28,70

Anwendungsbeispiele  
Application examples



% Sonderpreis / Sale Artikel. Lieferbar solange Vorrat.  
Special price / sale article. While stocks last.



11 6059



11 4059



FORM / SHAPE

KSJ / ZYA

Kegel 60° + Zylinder

Countersink 60° + cylinder

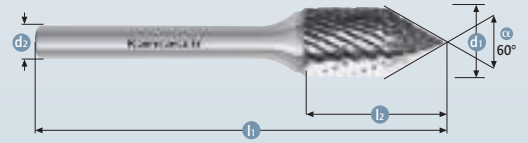

Schnittdaten  
Cutting data

Film  
Movie



Art.	d1	l2	d2	l1	gelötet brazed	VHM solid	€
11 6059 100	12	25	6	70			21,50

Art.	d1	l2	d2	l1	gelötet brazed	VHM solid	€
11 4059 100	12	25	6	70			18,95

Anwendungsbeispiele  
Application examples



11 6060



11 4060

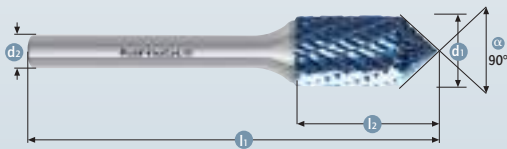

FORM / SHAPE

KSK / ZYA

Kegel 90° + Zylinder

Countersink 90° + cylinder

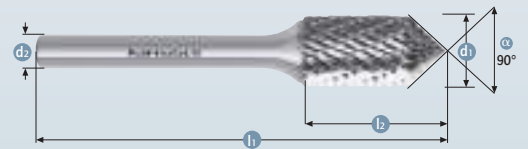
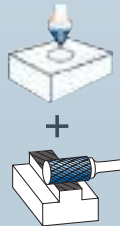

Schnittdaten  
Cutting data

Film  
Movie



Art.	d1	l2	d2	l1	gelötet brazed	VHM solid	€
11 6060 100	12	25	6	70			19,55

Art.	d1	l2	d2	l1	gelötet brazed	VHM solid	€
11 4060 100	12	25	6	70			16,95

Anwendungsbeispiele  
Application examples



- 1
- 2
- 3
- 4
- 5
- 6
- 7
- 8
- 9
- 10

11 6061



11 4061

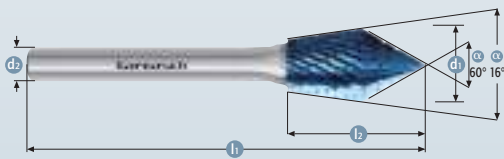

FORM / SHAPE

KSJ / WKN

Kegel 60° + Winkel

Countersink 60° + inverted cone

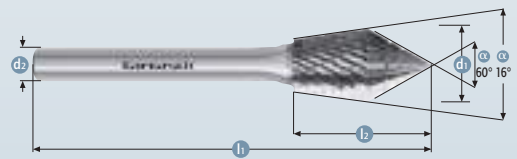

Schnittdaten  
Cutting data



753

Film  
Movie



Art.	d1	l2	d2	l1	gelötet brazed	VHM solid	€
11 6061 100	12	23	6	68			19,55

Art.	d1	l2	d2	l1	gelötet brazed	VHM solid	€
11 4061 100	12	23	6	68			16,95

Anwendungsbeispiele  
Application examples



Qualitätsprodukte für die Metallbearbeitung.  
Quality products for metalworking.

**Karnasch®**  
PROFESSIONAL TOOLS

**HOCHLEISTUNG**  
FÜR JEDEN ANWENDUNGSBEREICH

High performance in every application area

DAS KARNASCH PRODUKTSORTIMENT ONLINE!  
THE KARNASCH PRODUCT RANGE ONLINE!

<https://shop.karnasch.tools>



11 6063



11 4063



FORM / SHAPE

KSK / KSK

Kegel 90° + Kegel 90°

Countersink 90° + countersink 90°

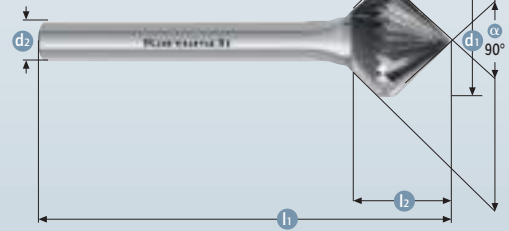
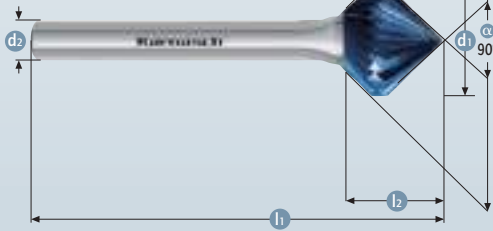

Schnittdaten  
Cutting data

Film  
Movie



753

753

Art.	d1	l2	d2	l1	gelötet brazed	VHM solid	€
11 6063 100	• 16	15	6	60			52,30

Art.	d1	l2	d2	l1	gelötet brazed	VHM solid	€
11 4063 100	• 16	15	6	60			47,40

Anwendungsbeispiele  
Application examples



Qualitätsprodukte für die Metallbearbeitung.  
Quality products for metalworking.

Karnasch®  
PROFESSIONAL TOOLS

PRODUKTIVITÄT  
FÜR INDUSTRIEKUNDEN WELTWEIT

Productivity for industrial clients worldwide

DAS KARNASCH PRODUKTSORTIMENT ONLINE!  
THE KARNASCH PRODUCT RANGE ONLINE!

<https://shop.karnasch.tools>

- 1
- 2
- 3
- 4
- 5
- 6
- 7
- 8
- 9
- 10

## Anwendungsbeispiele / Application examples



### Reifenreparatur

Frässtifte für exakte Schadensbearbeitung an Radial und Diagonalreifen.

Geeignet für Reparaturen an Autoreifen, LKW Reifen, Reifen für Fahrzeuge in der Landwirtschaft sowie Baufahrzeugreifen.

Die speziell angepasste Schneidgeometrie ermöglicht eine saubere und Professionelle Bearbeitung des Lochkanals.

### Vorgehensweise – Bearbeiten des Lochkanals

Mit einem Vorstecher ist der Verlauf des Lochkanals von innen nach außen festzustellen. Somit wird die Schadensgröße innen und außen am Reifen gemessen (max. 6 mm).

Der Lochkanal wird mit einem **passenden Frässtift** zuerst von innen nach außen und dann von außen nach innen bearbeitet und gesäubert.

Hierbei ist besonders darauf zu achten, dass der Schadenskanal genau durchdrungen wird, ohne den Schaden zu vergrößern, intakte Cordseile nicht verletzt werden und eine Aufweitung/Lösung des umliegenden Gewebes vermieden wird.

Werden hierbei weiterreichende Schäden wie Rostbildung oder Lösung festgestellt, muss der Reifen einer nochmaligen Prüfung auf die Reparaturfähigkeit mit vorgefertigten Reparaturkörpern unterzogen werden.

### Tyre repair

Rotating mills for precise damage processing at radial and diagonal tyres.

Suitable for repairs to car tyres, truck tyres, tyres for agricultural vehicles and construction vehicle tyres.

The specifically adjusted cutting geometry permits clean and professional processing of the hole channel.

### Procedure – Processing the hole channel

The course of the hole channel from the inside out is to be determined with a pricking awl. This measures the damage size on the inside and the outside of the tyre (max. 6 mm).

The hole channel is first processed and cleaned with a **matching rotating mill** from the inside outwards and then from the outside inwards.

For this, it must be particularly observed that the damage channel is penetrated precisely without enlarging the damage, that intact cord ropes are not damaged and that expansion/loosening of the surrounding tissue is avoided.

If further damage such as rust formation or loosening is found, the tyre must be inspected again for the possibility of repair with prefabricated repair elements.



- 1
- 2
- 3
- 4
- 5
- 6
- 7
- 8
- 9
- 10

11 4070

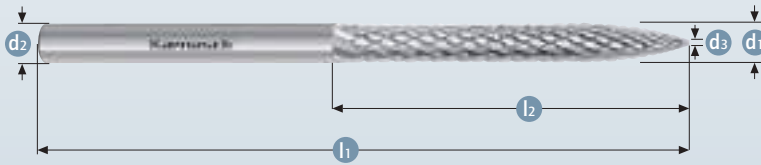

Geeignet für: Suitable for:	
Drehzahl: Rotational speed:	2500 U/min

Art.	d1	d3	l2	d2	l1	gelötet brazed	VHM solid	€
11 4070 100	3	0,4	25	3	50			9,05

11 4071

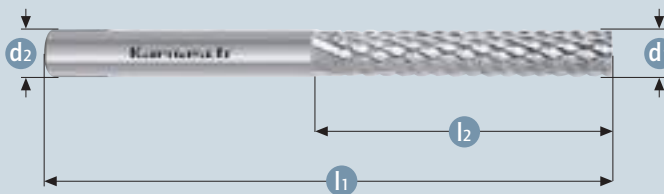

Geeignet für: Suitable for:	
Drehzahl: Rotational speed:	2500 U/min

Art.	d1	d3	l2	d2	l1	gelötet brazed	VHM solid	€
11 4071 100	6	-	35	6	65			17,20

11 4072

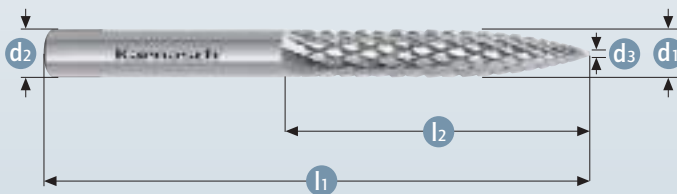

Geeignet für: Suitable for:	
Drehzahl: Rotational speed:	max. 2500 U/min

Art.	d1	d3	l2	d2	l1	gelötet brazed	VHM solid	€
11 4072 100	6	0,5	36	6	65			18,35

11 4073

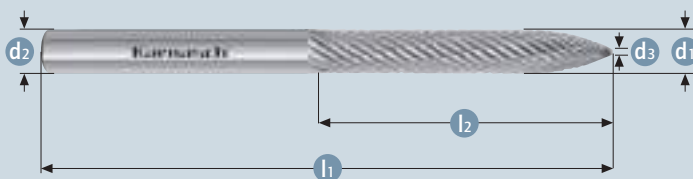

Geeignet für: Suitable for:	
Drehzahl: Rotational speed:	max. 2500 U/min

Art.	d1	d3	l2	d2	l1	gelötet brazed	VHM solid	€
11 4073 100	8	1	50	8	110			36,55





11 4074

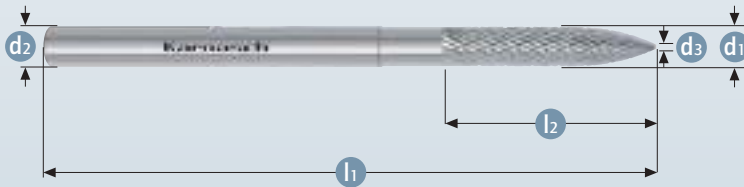

Geeignet für:  
Suitable for:



Drehzahl:  
Rotational speed:

2500 U/min

Art.	d1	d3	l2	d2	l1	gelötet brazed	VHM solid	€
11 4074 100 %	10	0,75	50	10	110	✓		32,10



11 4075

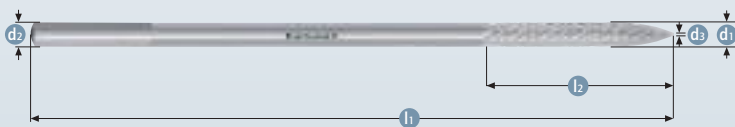

Geeignet für:  
Suitable for:



Drehzahl:  
Rotational speed:

2500 U/min

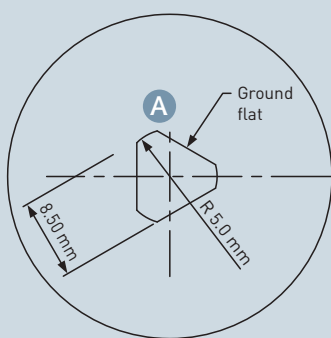

3 Flächen am Schaftende,  
dreieckiger Querschnitt mit Radius,  
auch geeignet für Bohrmaschinen

3 flats ground on diameter  
triangular section with radius,  
suitable for handheld machines

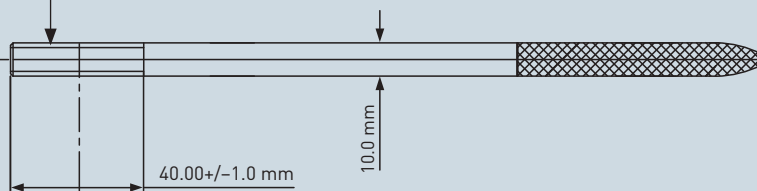

Art.	d1	d3	l2	d2 + A	l1	gelötet brazed	VHM solid	€
11 4075 100 %	10	0,75	75	10 + 3 Flächen + 3 flats	250	✓		94,35



- 1
- 2
- 3
- 4
- 5
- 6
- 7
- 8
- 9
- 10

11 4076

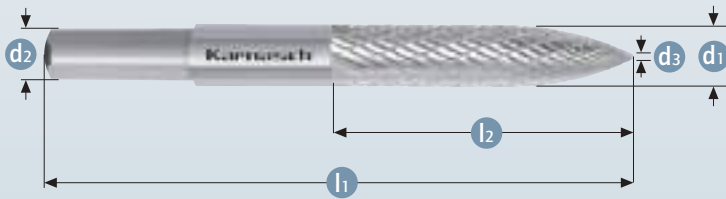

Geeignet für: Suitable for:	 
Drehzahl: Rotational speed:	max. 2500 U/min

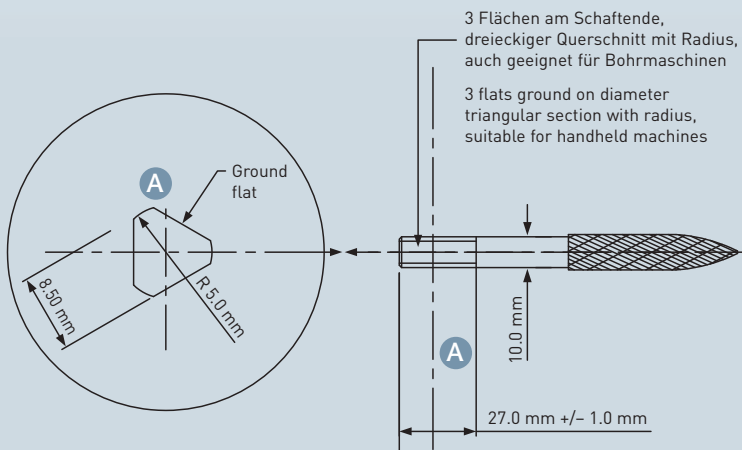

Art.	d1	d3	l2	d2 + A	l1	gelötet brazed	VHM solid	€
11 4076 100 %	12	0,8	55	10 + 3 Flächen + 3 flats	110	✓		57,25

11 4077

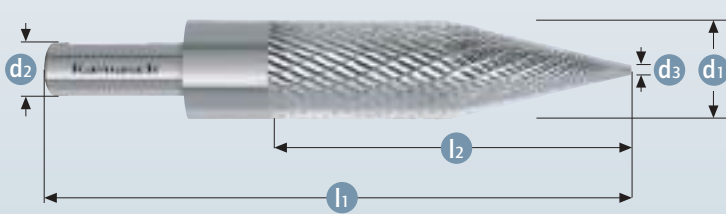

Geeignet für: Suitable for:	 
Drehzahl: Rotational speed:	max. 2500 U/min

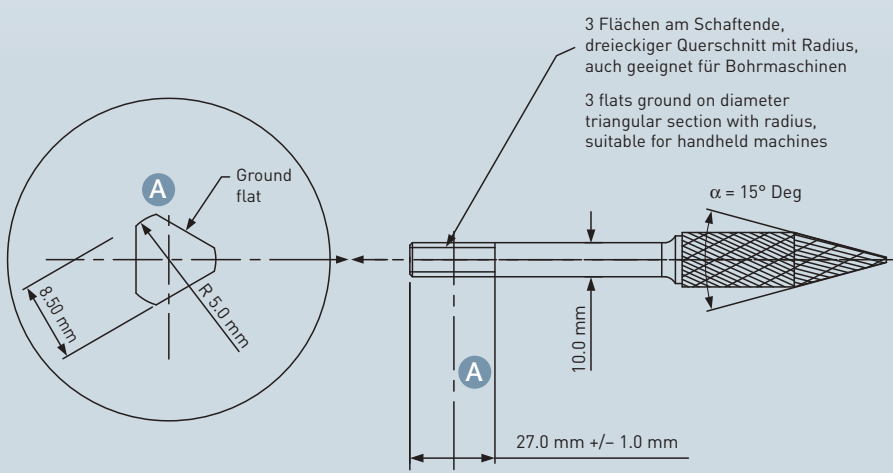

Art.	d1	d3	l2	d2 + A	l1	gelötet brazed	VHM solid	€
11 4077 100 %	16	1,5	60	10 + 3 Flächen + 3 flats	140	✓		134,05

 **11 4078**

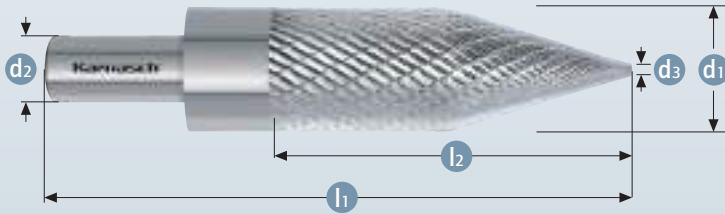

Geeignet für:  
Suitable for:



Drehzahl:  
Rotational speed:

max. 2500 U/min

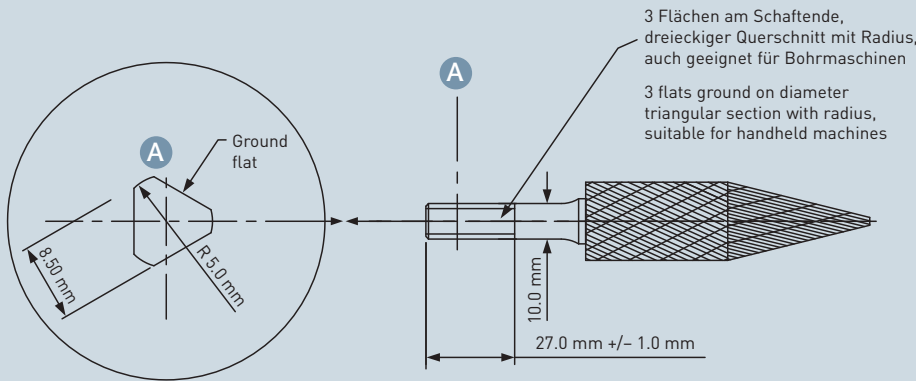

3 Flächen am Schaftende,  
dreieckiger Querschnitt mit Radius,  
auch geeignet für Bohrmaschinen

3 flats ground on diameter  
triangular section with radius,  
suitable for handheld machines

Art.	d1	d3	l2	d2 + A	l1	gelötet brazed	VHM solid	€
11 4078 100 %	22	2,2	80	10 + 3 Flächen + 3 flats	125	✓		203,55

**11 5031** 

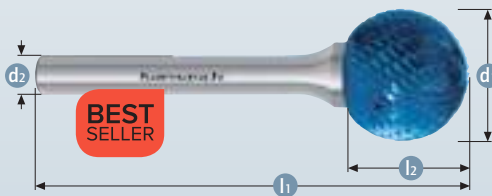

**D FORM / SHAPE** **KUD**

Kugel

Ball

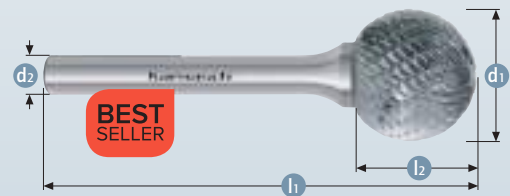

 **11 3031**

Geeignet für:  
Suitable for:



Drehzahl:  
Rotational speed:

max. 2500 U/min

Schnittdaten  
Cutting data



753

Film  
Movie





**Bestseller – preisreduziert · Bestseller – price reduced**

Art.	d1	l2	d2	l1	gelötet brazed	VHM solid	€
11 5031 105	20	16,5	6	62	✓		29,85

**Bestseller – preisreduziert · Bestseller – price reduced**

Art.	d1	l2	d2	l1	gelötet brazed	VHM solid	€
11 3031 105	20	16,5	6	62	✓		24,35



Qualitätsprodukte für die Metallbearbeitung.  
Quality products for metalworking.

# LEISTUNGSFÄHIGKEIT FÜR DEN TÄGLICHEN EINSATZ

Reliable performance in everyday service



**DAS KARNASCH PRODUKTSORTIMENT ONLINE!** Nutzen Sie unseren Onlineshop und profitieren Sie von den speziellen Vorteilen für Onlineshop-Kunden.

**THE KARNASCH PRODUCT RANGE ONLINE!** Use our onlineshop and benefit from the special advantages for onlineshop customers.



<https://shop.karnasch.tools>

SETS · DISPLAYS

SETS · DISPLAYS



1



2



3



4



5



6



7



8



9



10

Index

5.4

KONTAKT | CONTACT

**KARNASCH PROFESSIONAL TOOLS<sup>®</sup>**  
**INDUSTRIAL TOOLS DIVISION**

Straße des Friedens 10  
D-15848 Tauche/OT Görzdorf  
mail@karnasch.tools

**+49 (0) 33675 - 7265-0**

KARNASCH ONLINESHOP

**JETZT FÜR SIE ONLINE!**  
**NOW ONLINE FOR YOU!**

<http://shop.karnasch.tools>



ONLINE



- 1
- 2
- 3
- 4
- 5
- 6
- 7
- 8
- 9
- 10

11 4964

BEST SELLER

€ 108,10



BEST SELLER

€ 88,95

11 4964 U



neu  
new

5 Stück

5 pieces

Film  
Movie

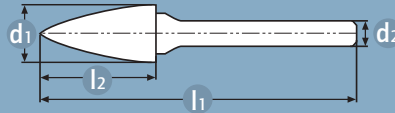

neu  
new

BEST SELLER

Bestseller – preisreduziert  
Bestseller – price reduced



### HP-3 Pro Performance 82



Zahnung  
Cut



BEST SELLER

Bestseller – preisreduziert  
Bestseller – price reduced

Art.	d1	l2	d2	l1
11 6091 030	• 10	20	6	65
11 6092 030	• 10	20	6	65
11 6095 030	• 10	20	6	65
11 6096 030	• 10	20	6	65
11 6098 030	• 10	20	6	65

Form Shape	DIN 8033	Inhalt   Contents
<b>B</b>	ZYB	1x Zylinder mit Stirnverzahnung Cylinder with end cut
<b>C</b>	WRC	1x Walzenrundform Ball nosed cylinder
<b>F</b>	RBF	1x Rundbogen Ball nosed tree
<b>G</b>	SPG	1x Spitzbogen Tree
<b>L</b>	KEL	1x Rundkegel Ball nosed cone

Art.	d1	l2	d2	l1
11 4091 030	• 10	20	6	65
11 4092 030	• 10	20	6	65
11 4095 030	• 10	20	6	65
11 4096 030	• 10	20	6	65
11 4098 030	• 10	20	6	65

11 4947

Leeres Set /  
Empty set

€ 9,50



Sie wollen einen anderen Inhalt? Kein Problem! Wählen Sie aus unserem Gesamt-sortiment 6 mm Schäfte aus. Beachten Sie dabei die maximale Länge von 86 mm.

Would you like a display of mini-burrs? No problem! Select 6.0 mm shafts from the complete list of products. Note that the maximum length is 86 mm.

11 4966

BEST SELLER

€ 148,40



BEST SELLER

€ 128,65

11 4966 U



5 Stück  
5 pieces

Film  
Movie

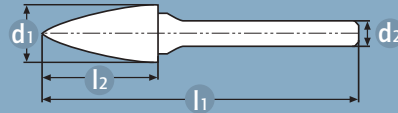

BEST SELLER

Bestseller – preisreduziert  
Bestseller – price reduced



HP-3 Pro Performance 82



Zahnung  
Cut



Art.	d1	l2	d2	l1
11 6091 040	• 12	25	6	70
11 6092 040	• 12	25	6	70
11 6095 040	• 12	25	6	70
11 6096 040	• 12	25	6	70
11 6098 040	• 12	25	6	70

Form Shape	DIN 8033	Inhalt   Contents
<b>B</b>	ZYB	1x Zylinder mit Stirnverzahnung Cylinder with end cut
<b>C</b>	WRC	1x Walzenrundform Ball nosed cylinder
<b>F</b>	RBF	1x Rundbogen Ball nosed tree
<b>G</b>	SPG	1x Spitzbogen Tree
<b>L</b>	KEL	1x Rundkegel Ball nosed cone

Art.	d1	l2	d2	l1
11 4091 040	• 12	25	6	70
11 4092 040	• 12	25	6	70
11 4095 040	• 12	25	6	70
11 4096 040	• 12	25	6	70
11 4098 040	• 12	25	6	70

Sie wollen einen anderen Inhalt? Kein Problem! Wählen Sie aus unserem Gesamt-sortiment 6 mm Schäfte aus. Beachten Sie dabei die maximale Länge von 86 mm.

Would you like a display of mini-burrs? No problem! Select 6.0 mm shafts from the complete list of products. Note that the maximum length is 86 mm.

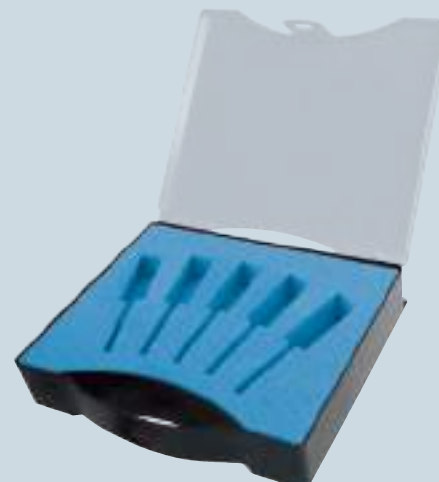

11 4947

Leeres Set /  
Empty set

€ 9,50



- 1
- 2
- 3
- 4
- 5
- 6
- 7
- 8
- 9
- 10

- 1
- 2
- 3
- 4
- 5
- 6
- 7
- 8
- 9
- 10

11 4918

BEST SELLER

€ 98,65



5 Stück

5 pieces

Film  
Movie

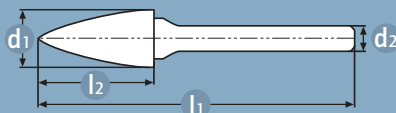

BEST SELLER

Bestseller – preisreduziert  
Bestseller – price reduced



### Universal HP-3



Zahnung  
Cut



Art.	d1	l2	d2	l1
11 5011 085	• 10	20	6	65
11 5021 085	• 10	20	6	65
11 5051 040	• 10	20	6	65
11 5061 045	• 10	20	6	65
11 5081 035	• 10	30	6	75

Form Shape	DIN 8033	Inhalt   Contents
<b>B</b>	ZYB	1x Zylinder mit Stirnverzahnung Cylinder with end cut
<b>C</b>	WRC	1x Walzenrundform Ball nosed cylinder
<b>F</b>	RBF	1x Rundbogen Ball nosed tree
<b>G</b>	SPG	1x Spitzbogen Tree
<b>L</b>	KEL	1x Rundkegel Ball nosed cone

BEST SELLER

€ 75,30



VALUETOOL

€ 59,65

neu  
new

11 4918 U

11 4919 U

BEST SELLER

Bestseller – preisreduziert  
Bestseller – price reduced



Valuetool – hervorragendes Preis-Leistungs-Verhältnis  
Valuetool – excellent price-performance ratio

Art. BESTSELLER	Art. VALUETOOL	d1	l2	d2	l1
11 3011 085	11 3011 086	• 10	20	6	65
11 3021 085	11 3021 086	• 10	20	6	65
11 3051 040	11 3051 041	• 10	20	6	65
11 3061 045	11 3061 046	• 10	20	6	65
11 3081 035	11 3081 031	• 10	30 20	6	75 65

11 4947

Leeres Set /  
Empty set

€ 9,50



Sie wollen einen anderen Inhalt? Kein Problem! Wählen Sie aus unserem Gesamt-sortiment 6 mm Schäfte aus. Beachten Sie dabei die maximale Länge von 86 mm.

Would you like a display of mini-burrs? No problem! Select 6.0 mm shafts from the complete list of products. Note that the maximum length is 86 mm.



11 4926

BEST SELLER

€ 124,80



5 Stück  
5 pieces

Film  
Movie

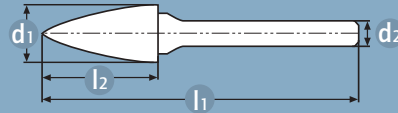

BEST SELLER

Bestseller – preisreduziert  
Bestseller – price reduced



Universal HP-3



Zahnung  
Cut



Art.	d1	l2	d2	l1
11 5011 100	• 12	25	6	70
11 5021 105	• 12	25	6	70
11 5051 050	• 12	25	6	70
11 5061 060	• 12	25	6	70
11 5081 045	• 12	25	6	77

Form Shape	DIN 8033	Inhalt   Contents
<b>B</b>	ZYB	1x Zylinder mit Stirnverzahnung Cylinder with end cut
<b>C</b>	WRC	1x Walzenrundform Ball nosed cylinder
<b>F</b>	RBF	1x Rundbogen Ball nosed tree
<b>G</b>	SPG	1x Spitzbogen Tree
<b>L</b>	KEL	1x Rundkegel Ball nosed cone



BEST SELLER

€ 103,80

11 4926 U

VALUETOOL

€ 73,95

neu  
new

11 4927 U



BEST SELLER

Bestseller – preisreduziert  
Bestseller – price reduced

VALUETOOL

Valuetool – hervorragendes Preis-Leistungs-Verhältnis  
Valuetool – excellent price-performance ratio

Art. BESTSELLER	Art. VALUETOOL	d1	l2	d2	l1
11 3011 100	11 3011 104	• 12	25	6	70
11 3021 105	11 3021 108	• 12	25	6	70
11 3051 050	11 3051 054	• 12	25	6	70
11 3061 060	11 3061 064	• 12	25	6	70
11 3081 045	11 3081 048	• 12	32 25	6	77 70

Sie wollen einen anderen Inhalt? Kein Problem! Wählen Sie aus unserem Gesamt-sortiment 6 mm Schäfte aus. Beachten Sie dabei die maximale Länge von 86 mm.

Would you like a display of mini-burrs? No problem! Select 6.0 mm shafts from the complete list of products. Note that the maximum length is 86 mm.

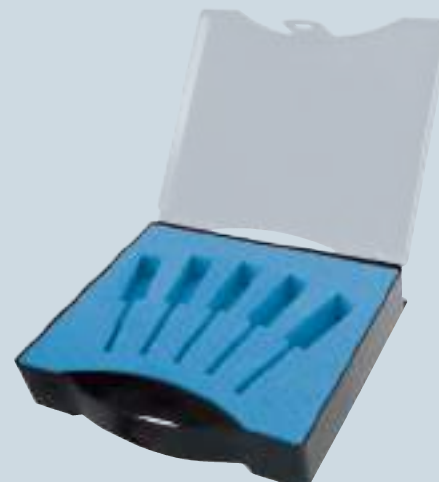

11 4947

Leeres Set /  
Empty set

€ 9,50



1



2



3



4



5



6



7



8



9



10



Index

- 1
- 2
- 3
- 4
- 5
- 6
- 7
- 8
- 9
- 10

11 4907

BEST SELLER

€ 115,45



BEST SELLER

€ 94,40

11 4907 U



5 Stück  
5 pieces

Film  
Movie

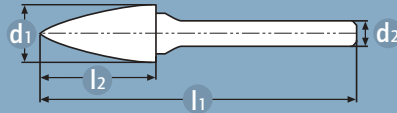

BEST SELLER

Bestseller – preisreduziert  
Bestseller – price reduced



**Universal HP-3**



Zahnung  
Cut



BEST SELLER

Bestseller – preisreduziert  
Bestseller – price reduced

Art.	d1	l2	d2	l1
11 5011 103	• 12,0 DIN	25	6	70
11 5021 107	• 12,0 DIN	25	6	70
11 5051 053	• 12,0 DIN	25	6	70
11 5061 063	• 12,0 DIN	25	6	70
11 5081 047	• 12,0 DIN	25	6	70

Form Shape	DIN 8033	Inhalt   Contents
<b>B</b>	ZYB	1x Zylinder mit Stirnverzahnung Cylinder with end cut
<b>C</b>	WRC	1x Walzenrundform Ball nosed cylinder
<b>F</b>	RBF	1x Rundbogen Ball nosed tree
<b>G</b>	SPG	1x Spitzbogen Tree
<b>L</b>	KEL	1x Rundkegel Ball nosed cone

Art.	d1	l2	d2	l1
11 3011 103	• 12,0 DIN	25	6	70
11 3021 107	• 12,0 DIN	25	6	70
11 3051 053	• 12,0 DIN	25	6	70
11 3061 063	• 12,0 DIN	25	6	70
11 3081 047	• 12,0 DIN	25	6	70

11 4947

Leeres Set /  
Empty set

€ 9,50



Sie wollen einen anderen Inhalt? Kein Problem! Wählen Sie aus unserem Gesamt-sortiment 6 mm Schäfte aus. Beachten Sie dabei die maximale Länge von 86 mm.

Would you like a display of mini-burrs? No problem! Select 6.0 mm shafts from the complete list of products. Note that the maximum length is 86 mm.

11 4968

BEST SELLER

€ 248,15



BEST SELLER

€ 209,25

11 4968 U



10 Stück  
10 pieces

Film  
Movie

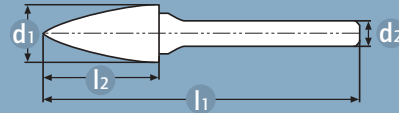

BEST SELLER

Bestseller – preisreduziert  
Bestseller – price reduced



### HP-3 Pro Performance 82



Zahnung  
Cut



Art.	d1	l2	d2	l1
11 6091 030	• 10	20	6	65
11 6092 030	• 10	20	6	65
11 6095 030	• 10	20	6	65
11 6096 030	• 10	20	6	65
11 6098 030	• 10	20	6	65
11 6091 040	• 12	25	6	70
11 6092 040	• 12	25	6	70
11 6095 040	• 12	25	6	70
11 6096 040	• 12	25	6	70
11 6098 040	• 12	25	6	77

Form Shape	DIN 8033	Inhalt   Contents
<b>B</b>	ZYB	1x Zylinder mit Stirnverzahnung Cylinder with end cut
<b>C</b>	WRC	1x Walzenrundform Ball nosed cylinder
<b>F</b>	RBF	1x Rundbogen Ball nosed tree
<b>G</b>	SPG	1x Spitzbogen Tree
<b>L</b>	KEL	1x Rundkegel Ball nosed cone
<b>B</b>	ZYB	1x Zylinder mit Stirnverzahnung Cylinder with end cut
<b>C</b>	WRC	1x Walzenrundform Ball nosed cylinder
<b>F</b>	RBF	1x Rundbogen Ball nosed tree
<b>G</b>	SPG	1x Spitzbogen Tree
<b>L</b>	KEL	1x Rundkegel Ball nosed cone

Art.	d1	l2	d2	l1
11 4091 030	• 10	20	6	65
11 4092 030	• 10	20	6	65
11 4095 030	• 10	20	6	65
11 4096 030	• 10	20	6	65
11 4098 030	• 10	20	6	65
11 4091 040	• 12	25	6	70
11 4092 040	• 12	25	6	70
11 4095 040	• 12	25	6	70
11 4096 040	• 12	25	6	70
11 4098 040	• 12	25	6	77

Sie wollen einen anderen Inhalt? Kein Problem! Wählen Sie aus unserem Gesamt-sortiment 6 mm Schäfte aus. Beachten Sie dabei die maximale Länge von 86 mm.

Would you like a display of mini-burrs? No problem! Select 6.0 mm shafts from the complete list of products. Note that the maximum length is 86 mm.



11 4950

Leeres Set /  
Empty set

€ 9,50



- 1
- 2
- 3
- 4
- 5
- 6
- 7
- 8
- 9
- 10

- 1
- 2
- 3
- 4
- 5
- 6
- 7
- 8
- 9
- 10

11 4970

BEST SELLER

€ 290,55



BEST SELLER

€ 251,10

11 4970 U



neu  
new

10 Stück  
10 pieces

Film  
Movie

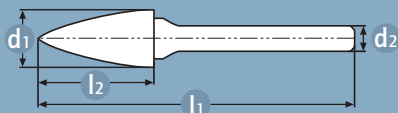

neu  
new

BEST SELLER

Bestseller – preisreduziert  
Bestseller – price reduced



**HP-3 Pro Performance 82**



Zahnung  
Cut



BEST SELLER

Bestseller – preisreduziert  
Bestseller – price reduced

Art.	d1	l2	d2	l1
11 6090 040	• 12	25	6	70
11 6091 040	• 12	25	6	70
11 6092 040	• 12	25	6	70
11 6093 040	• 12	11	6	56
11 6094 040	• 12	21	6	66
11 6095 040	• 12	25	6	70
11 6096 040	• 12	25	6	70
11 6097 040	• 12	30	6	75
11 6098 040	• 12	25	6	70
11 6099 040	• 12	25	6	70

Form Shape	DIN 8033	Inhalt   Contents
<b>A</b>	ZYA	1x Zylinder ohne Stirnverzahnung Cylinder without end cut
<b>B</b>	ZYB	1x Zylinder mit Stirnverzahnung Cylinder with end cut
<b>C</b>	WRC	1x Walzenrundform Ball nosed cylinder
<b>D</b>	KUD	1x Kugel Ball
<b>E</b>	TRE	1x Tropfen Oval
<b>F</b>	RBF	1x Rundbogen Ball nosed tree
<b>G</b>	SPG	1x Spitzbogen Tree
<b>H</b>	-	1x Flamme Flame
<b>L</b>	KEL	1x Rundkegel Ball nosed cone
<b>M</b>	SKM	1x Spitzkegel Cone

Art.	d1	l2	d2	l1
11 4090 040	• 12	25	6	70
11 4091 040	• 12	25	6	70
11 4092 040	• 12	25	6	70
11 4093 040	• 12	11	6	56
11 4094 040	• 12	21	6	66
11 4095 040	• 12	25	6	70
11 4096 040	• 12	25	6	70
11 4097 040	• 12	30	6	75
11 4098 040	• 12	25	6	70
11 4099 040	• 12	25	6	70

11 4950

Leeres Set /  
Empty set

€ 9,50



Sie wollen einen anderen Inhalt? Kein Problem! Wählen Sie aus unserem Gesamtsortiment 6 mm Schäfte aus. Beachten Sie dabei die maximale Länge von 86 mm.

Would you like a display of mini-burrs? No problem! Select 6.0 mm shafts from the complete list of products. Note that the maximum length is 86 mm.

11 4934

BEST SELLER

€ 216,30



BEST SELLER

€ 171,95

11 4934 U



10 Stück  
10 pieces

Film  
Movie

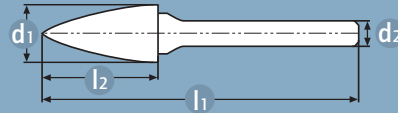

VALUETOOL

€ 126,45

neu  
new

11 4935 U

BEST SELLER

Bestseller – preisreduziert  
Bestseller – price reduced



Universal HP-3



Zahnung  
Cut



BEST SELLER

Bestseller – preisreduziert  
Bestseller – price reduced



Valuetool – hervorragendes Preis-Leistungs-Verhältnis  
Valuetool – excellent price-performance ratio

Art.	d1	l2	d2	l1
11 5011 085	• 10	20	6	65
11 5021 085	• 10	20	6	65
11 5051 040	• 10	20	6	65
11 5061 045	• 10	20	6	65
11 5081 035	• 10	30	6	75
11 5011 100	• 12	25	6	70
11 5021 105	• 12	25	6	70
11 5051 050	• 12	25	6	70
11 5061 060	• 12	25	6	70
11 5081 045	• 12	32	6	77

Form Shape	DIN 8033	Inhalt   Contents
<b>B</b>	ZYB	1x Zylinder mit Stirnverzahnung Cylinder with end cut
<b>C</b>	WRC	1x Walzenrundform Ball nosed cylinder
<b>F</b>	RBF	1x Rundbogen Ball nosed tree
<b>G</b>	SPG	1x Spitzbogen Tree
<b>L</b>	KEL	1x Rundkegel Ball nosed cone
<b>B</b>	ZYB	1x Zylinder mit Stirnverzahnung Cylinder with end cut
<b>C</b>	WRC	1x Walzenrundform Ball nosed cylinder
<b>F</b>	RBF	1x Rundbogen Ball nosed tree
<b>G</b>	SPG	1x Spitzbogen Tree
<b>L</b>	KEL	1x Rundkegel Ball nosed cone

Art. BESTSELLER	Art. VALUETOOL	d1	l2	d2	l1
11 3011 085	11 3011 086	• 10	20	6	65
11 3021 085	11 3021 086	• 10	20	6	65
11 3051 040	11 3051 041	• 10	20	6	65
11 3061 045	11 3061 046	• 10	20	6	65
11 3081 035	11 3081 031	• 10	30 20	6	75 65
11 3011 100	11 3011 104	• 12	25	6	70
11 3021 105	11 3021 108	• 12	25	6	70
11 3051 050	11 3051 054	• 12	25	6	70
11 3061 060	11 3061 064	• 12	25	6	70
11 3081 045	11 3081 048	• 12	32 25	6	77 70

Sie wollen einen anderen Inhalt? Kein Problem! Wählen Sie aus unserem Gesamt-sortiment 6 mm Schäfte aus. Beachten Sie dabei die maximale Länge von 86 mm.

Would you like a display of mini-burrs? No problem! Select 6.0 mm shafts from the complete list of products. Note that the maximum length is 86 mm.



11 4950

Leeres Set /  
Empty set

€ 9,50



- 1
- 2
- 3
- 4
- 5
- 6
- 7
- 8
- 9
- 10

- 1
- 2
- 3
- 4
- 5
- 6
- 7
- 8
- 9
- 10

**11 4942** **BEST SELLER** € 245,40

**BEST SELLER** € 203,35 **11 4942 U**



10 Stück  
10 pieces

Film  
Movie

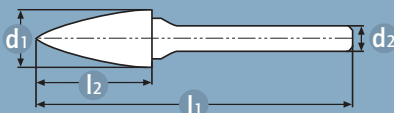

**VALUETOOL** € 141,85 **neu new** **11 4943 U**



**BEST SELLER** Bestseller – preisreduziert  
Bestseller – price reduced



**Universal HP-3**



Zahnung  
Cut



**BEST SELLER** Bestseller – preisreduziert  
Bestseller – price reduced



Valuetool – hervorragendes Preis-Leistungs-Verhältnis  
Valuetool – excellent price-performance ratio

Art.	d1	l2	d2	l1
11 5001 105	• 12	25	6	70
11 5011 100	• 12	25	6	70
11 5021 105	• 12	25	6	70
11 5031 080	• 12	11,4	6	65
11 5041 035	• 12	22	6	67
11 5051 050	• 12	25	6	70
11 5061 060	• 12	25	6	70
11 5071 025	• 12	32	6	77
11 5081 045	• 12	32	6	77
11 5091 045	• 12	25	6	70

Form Shape	DIN 8033	Inhalt   Contents
<b>A</b>	ZYA	1x Zylinder ohne Stirnverzahnung Cylinder without end cut
<b>B</b>	ZYB	1x Zylinder mit Stirnverzahnung Cylinder with end cut
<b>C</b>	WRC	1x Walzenrundform Ball nosed cylinder
<b>D</b>	KUD	1x Kugel Ball
<b>E</b>	TRE	1x Tropfen Oval
<b>F</b>	RBF	1x Rundbogen Ball nosed tree
<b>G</b>	SPG	1x Spitzbogen Tree
<b>H</b>	-	1x Flamme Flame
<b>L</b>	KEL	1x Rundkegel Ball nosed cone
<b>M</b>	SKM	1x Spitzkegel Cone

Art. BESTSELLER	Art. VALUETOOL	d1	l2	d2	l1
11 3001 105	11 3001 108	• 12	25	6	70
11 3011 100	11 3011 104	• 12	25	6	70
11 3021 105	11 3021 108	• 12	25	6	70
11 3031 080	11 3031 084	• 12	11,4	6	65 56
11 3041 035	11 3041 036	• 12	22	6	67 66
11 3051 050	11 3051 054	• 12	25	6	70
11 3061 060	11 3061 064	• 12	25	6	70
11 3071 025	11 3071 026	• 12	32	6	77 75
11 3081 045	11 3081 048	• 12	32	6	77 70
11 3091 045	11 3091 048	• 12	25	6	70

**11 4950**

Leeres Set /  
Empty set

€ 9,50



Sie wollen einen anderen Inhalt? Kein Problem! Wählen Sie aus unserem Gesamtsortiment 6 mm Schäfte aus. Beachten Sie dabei die maximale Länge von 86 mm.

Would you like a display of mini-burrs? No problem! Select 6.0 mm shafts from the complete list of products. Note that the maximum length is 86 mm.

11 4911

BEST SELLER

€ 227,80



BEST SELLER

€ 184,35

114911U



DIN

10 Stück  
10 pieces

Film  
Movie

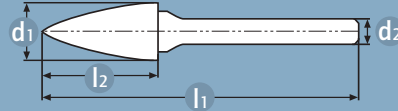

DIN

BEST SELLER

Bestseller – preisreduziert  
Bestseller – price reduced



Universal HP-3



Zahnung  
Cut



BEST SELLER

Bestseller – preisreduziert  
Bestseller – price reduced

Art.	d1	l2	d2	l1
11 5001 107	• 12,0 DIN	25	6	70
11 5011 103	• 12,0 DIN	25	6	70
11 5021 107	• 12,0 DIN	25	6	70
11 5031083	• 12,0 DIN	11,4	6	65
11 5041 037	• 12,0 DIN	22	6	66
11 5051 053	• 12,0 DIN	25	6	70
11 5061 063	• 12,0 DIN	25	6	70
11 5071 027	• 12,0 DIN	32	6	70
11 5081 047	• 12,0 DIN	32	6	70
11 5091 047	• 12,0 DIN	25	6	70

Form Shape	DIN 8033	Inhalt   Contents
<b>A</b>	ZYA	1x Zylinder ohne Stirnverzahnung Cylinder without end cut
<b>B</b>	ZYB	1x Zylinder mit Stirnverzahnung Cylinder with end cut
<b>C</b>	WRC	1x Walzenrundform Ball nosed cylinder
<b>D</b>	KUD	1x Kugel Ball
<b>E</b>	TRE	1x Tropfen Oval
<b>F</b>	RBF	1x Rundbogen Ball nosed tree
<b>G</b>	SPG	1x Spitzbogen Tree
<b>H</b>	-	1x Flamme Flame
<b>L</b>	KEL	1x Rundkegel Ball nosed cone
<b>M</b>	SKM	1x Spitzkegel Cone

Art.	d1	l2	d2	l1
11 3001 107	• 12,0 DIN	25	6	70
11 3011 103	• 12,0 DIN	25	6	70
11 3021 107	• 12,0 DIN	25	6	70
11 3031 083	• 12,0 DIN	11,4	6	65
11 3041 037	• 12,0 DIN	22	6	66
11 3051 053	• 12,0 DIN	25	6	70
11 3061 063	• 12,0 DIN	25	6	70
11 3071 027	• 12,0 DIN	32	6	70
11 3081 047	• 12,0 DIN	32	6	70
11 3091 047	• 12,0 DIN	25	6	70

Sie wollen einen anderen Inhalt? Kein Problem! Wählen Sie aus unserem Gesamt-sortiment 6 mm Schäfte aus. Beachten Sie dabei die maximale Länge von 86 mm.

Would you like a display of mini-burrs? No problem! Select 6.0 mm shafts from the complete list of products. Note that the maximum length is 86 mm.



11 4950

Leeres Set /  
Empty set

€ 9,50



- 1
- 2
- 3
- 4
- 5
- 6
- 7
- 8
- 9
- 10

- 1
- 2
- 3
- 4
- 5
- 6
- 7
- 8
- 9
- 10

11 4960

BEST SELLER

€ 863,50



BEST SELLER

€ 738,80

11 4960 U



neu  
new

Abschließbares Display Ø 6, 8, 10, 12 mm,  
Schaft 6 mm (40 Stück)

Lockable display Ø 6, 8, 10, 12 mm,  
shank 6 mm (40 pieces)

Film  
Movie



neu  
new

BEST SELLER

Bestseller – preisreduziert  
Bestseller – price reduced



## HP-3 Pro Performance 82



Zahnung  
Cut



Art.	d1	l2	d2	l1
11 6091 051	• 6	18	6	50
11 6091 076	• 8	20	6	65
11 6091 086	• 10	20	6	65
11 6091 104	• 12	25	6	70
11 6092 054	• 6	18	6	50
11 6092 076	• 8	20	6	65
11 6092 086	• 10	20	6	65
11 6092 108	• 12	25	6	70
11 6095 031	• 6	18	6	50
11 6095 036	• 8	20	6	65
11 6095 041	• 10	20	6	65
11 6095 054	• 12	25	6	70
11 6096 036	• 6	18	6	50
11 6096 041	• 8	20	6	65
11 6096 046	• 10	20	6	65
11 6096 064	• 12	25	6	70
11 6098 021	• 6	18	6	50
11 6098 026	• 8	25	6	50
11 6098 031	• 10	20	6	65
11 6098 048	• 12	32	6	77

Form Shape	DIN 8033	Inhalt   Contents
<b>B</b>	ZYB	2x Zylinder mit Stirnverzahnung Cylinder with end cut
<b>C</b>	WRC	2x Walzenrundform Ball nosed cylinder
<b>F</b>	RBF	2x Rundbogen Ball nosed tree
<b>G</b>	SPG	2x Spitzbogen Tree
<b>L</b>	KEL	2x Rundkegel Ball nosed cone

BEST SELLER

Bestseller – preisreduziert  
Bestseller – price reduced

Art.	d1	l2	d2	l1
11 4091 051	• 6	18	6	50
11 4091 076	• 8	20	6	65
11 4091 086	• 10	20	6	65
11 4091 104	• 12	25	6	70
11 4092 054	• 6	18	6	50
11 4092 076	• 8	20	6	65
11 4092 086	• 10	20	6	65
11 4092 108	• 12	25	6	70
11 4095 031	• 6	18	6	50
11 4095 036	• 8	20	6	65
11 4095 041	• 10	20	6	65
11 4095 054	• 12	25	6	70
11 4096 036	• 6	18	6	50
11 4096 041	• 8	20	6	65
11 4096 046	• 10	20	6	65
11 4096 064	• 12	25	6	70
11 4098 021	• 6	18	6	50
11 4098 026	• 8	25	6	50
11 4098 031	• 10	20	6	65
11 4098 048	• 12	32	6	77

11 4945

Leeres Display /  
Empty display

€ 71,45



Sie wollen einen anderen Inhalt? Kein Problem! Wählen Sie aus unserem Gesamt-sortiment 6 mm Schäfte aus. Beachten Sie dabei die maximale Länge von 86 mm.

Would you like a display of mini-burrs? No problem! Select 6.0 mm shafts from the complete list of products. Note that the maximum length is 86 mm.



11 4853

BEST SELLER

€ 714,48



Abschließbares Display Ø 6, 8, 10, 12 mm,  
Schaft 6 mm (40 Stück)

Lockable display Ø 6, 8, 10, 12 mm,  
shank 6 mm (40 pieces)

Film  
Movie



BEST SELLER

Bestseller – preisreduziert  
Bestseller – price reduced



Universal HP-3



Zahnung  
Cut



Art.	d1	l2	d2	l1
11 5011 050	● 6	18	6	50
11 5011 075	● 8	20	6	65
11 5011 085	● 10	20	6	65
11 5011 100	● 12	25	6	70
11 5021 055	● 6	18	6	50
11 5021 075	● 8	20	6	65
11 5021 085	● 10	20	6	65
11 5021 105	● 12	25	6	70
11 5051 030	● 6	18	6	50
11 5051 035	● 8	20	6	65
11 5051 040	● 10	20	6	65
11 5051 050	● 12	25	6	70
11 5061 035	● 6	18	6	50
11 5061 040	● 8	20	6	65
11 5061 045	● 10	20	6	65
11 5061 060	● 12	25	6	70
11 5081 020	● 6	18	6	50
11 5081 025	● 8	25	6	50
11 5081 035	● 10	30	6	75
11 5081 045	● 12	32	6	77

Form Shape	DIN 8033	Inhalt   Contents
<b>B</b>	ZYB	2x Zylinder mit Stirnverzahnung Cylinder with end cut
<b>C</b>	WRC	2x Walzenrundform Ball nosed cylinder
<b>F</b>	RBF	2x Rundbogen Ball nosed tree
<b>G</b>	SPG	2x Spitzbogen Tree
<b>L</b>	KEL	2x Rundkegel Ball nosed cone

BEST SELLER

€ 608,38

11 4853 U

VALUETOOL

€ 468,18

neu  
new

11 4854 U



BEST SELLER

Bestseller – preisreduziert  
Bestseller – price reduced



Valuetool – hervorragendes Preis-Leistungs-Verhältnis  
Valuetool – excellent price-performance ratio

Art. BESTSELLER	Art. VALUETOOL	d1	l2	d2	l1
11 3011 050	11 3011 051	● 6	18	6	50
11 3011 075	11 3011 076	● 8	20	6	65
11 3011 085	11 3011 086	● 10	20	6	65
11 3011 100	11 3011 104	● 12	25	6	70
11 3021 055	11 3021 054	● 6	18	6	50
11 3021 075	11 3021 076	● 8	20	6	65
11 3021 085	11 3021 086	● 10	20	6	65
11 3021 105	11 3021 108	● 12	25	6	70
11 3051 030	11 3051 031	● 6	18	6	50
11 3051 035	11 3051 036	● 8	20	6	65
11 3051 040	11 3051 041	● 10	20	6	65
11 3051 050	11 3051 054	● 12	25	6	70
11 3061 035	11 3061 036	● 6	18	6	50
11 3061 040	11 3061 041	● 8	20	6	65
11 3061 045	11 3061 046	● 10	20	6	65
11 3061 060	11 3061 064	● 12	25	6	70
11 3081 020	11 3081 021	● 6	18	6	50
11 3081 025	11 3081 026	● 8	25	6	50
11 3081 035	11 3081 031	● 10	30 20	6	75 65
11 3081 045	11 3081 048	● 12	32 25	6	77 70

Sie wollen einen anderen Inhalt? Kein Problem! Wählen Sie aus unserem Gesamt-sortiment 6 mm Schäfte aus. Beachten Sie dabei die maximale Länge von 86 mm.

Would you like a display of mini-burrs? No problem! Select 6.0 mm shafts from the complete list of products. Note that the maximum length is 86 mm.



11 4945

Leeres Display /  
Empty display

€ 71,45



- 1
- 2
- 3
- 4
- 5
- 6
- 7
- 8
- 9
- 10

- 1
- 2
- 3
- 4
- 5
- 6
- 7
- 8
- 9
- 10

11 4962

BEST SELLER

€ 1385,20



BEST SELLER

€ 1185,30

11 4962 U



neu  
new

Abschließbares Display Ø 6, 8, 10, 12 mm,  
Schaft 6 mm (64 Stück)

Lockable display Ø 6, 8, 10, 12 mm,  
shank 6 mm (64 pieces)

Film  
Movie



neu  
new

BEST SELLER

Bestseller – preisreduziert  
Bestseller – price reduced



## HP-3 Pro Performance 82



Zahnung  
Cut



Art.	d1	l2	d2	l1
11 6090 066	• 6	18	6	50
11 6090 081	• 8	20	6	65
11 6090 091	• 10	20	6	65
11 6090 108	• 12	25	6	70
11 6091 051	• 6	18	6	50
11 6091 076	• 8	20	6	65
11 6091 086	• 10	20	6	65
11 6091 104	• 12	25	6	70
11 6092 054	• 6	18	6	50
11 6092 076	• 8	20	6	65
11 6092 086	• 10	20	6	65
11 6092 108	• 12	25	6	70
11 6094 021	• 6	10	6	50
11 6094 026	• 8	15	6	60
11 6094 031	• 10	16	6	60
11 6094 036	• 12	22	6	67
11 6095 031	• 6	18	6	50
11 6095 036	• 8	20	6	65
11 6095 041	• 10	20	6	65
11 6095 054	• 12	25	6	70
11 6096 036	• 6	18	6	50
11 6096 041	• 8	20	6	65
11 6096 046	• 10	20	6	65
11 6096 064	• 12	25	6	70
11 6097 011	• 6	14	6	50
11 6097 016	• 8	20	6	65
11 6097 021	• 10	20	6	65
11 6097 026	• 12	32	6	77
11 6098 021	• 6	18	6	50
11 6098 026	• 8	25	6	70
11 6098 031	• 10	20	6	65
11 6098 048	• 12	32	6	77

Form Shape	DIN 8033	Inhalt   Contents
<b>A</b>	ZYA	2x Zylinder ohne Stirnverzahnung Cylinder without end cut
<b>B</b>	ZYB	2x Zylinder mit Stirnverzahnung Cylinder with end cut
<b>C</b>	WRC	2x Walzenrundform Ball nosed cylinder
<b>E</b>	TRE	2x Tropfen Oval
<b>F</b>	RBF	2x Rundbogen Ball nosed tree
<b>G</b>	SPG	2x Spitzbogen Tree
<b>H</b>	-	2x Flamme Flame
<b>L</b>	KEL	2x Rundkegel Ball nosed cone

BEST SELLER

Bestseller – preisreduziert  
Bestseller – price reduced

Art.	d1	l2	d2	l1
11 4090 066	• 6	18	6	50
11 4090 081	• 8	20	6	65
11 4090 091	• 10	20	6	65
11 4090 108	• 12	25	6	70
11 4091 051	• 6	18	6	50
11 4091 076	• 8	20	6	65
11 4091 086	• 10	20	6	65
11 4091 104	• 12	25	6	70
11 4092 054	• 6	18	6	50
11 4092 076	• 8	20	6	65
11 4092 086	• 10	20	6	65
11 4092 108	• 12	25	6	70
11 4094 021	• 6	10	6	50
11 4094 026	• 8	15	6	60
11 4094 031	• 10	16	6	60
11 4094 036	• 12	22	6	67
11 4095 031	• 6	18	6	50
11 4095 036	• 8	20	6	65
11 4095 041	• 10	20	6	65
11 4095 054	• 12	25	6	70
11 4096 036	• 6	18	6	50
11 4096 041	• 8	20	6	65
11 4096 046	• 10	20	6	65
11 4096 064	• 12	25	6	70
11 4097 011	• 6	14	6	50
11 4097 016	• 8	20	6	65
11 4097 021	• 10	20	6	65
11 4097 026	• 12	32	6	77
11 4098 021	• 6	18	6	50
11 4098 026	• 8	25	6	70
11 4098 031	• 10	20	6	65
11 4098 048	• 12	32	6	77

11 4955

Leeres Display /  
Empty display

€ 38,92



11 4948

Leeres Display /  
Empty display

€ 81,65

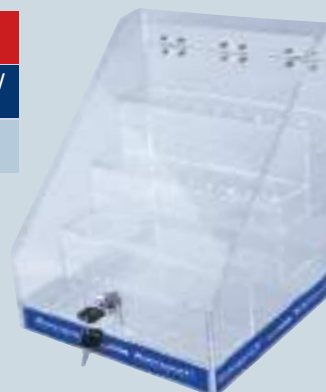

Sie wollen einen anderen  
Inhalt? Kein Problem!  
Wählen Sie aus unserem  
Gesamtsortiment 6 mm  
Schäfte aus. Beachten Sie  
dabei die maximale Länge  
von 86 mm.

Would you like a display of  
mini-burrs? No problem!  
Select 6.0 mm shafts from  
the complete list of products.  
Note that the maximum  
length is 86 mm.

11 4855

BEST SELLER

€ 1153,88



BEST SELLER

€ 983,88

11 4855 U



Abschließbares Display Ø 6, 8, 10, 12 mm, Schaft 6 mm (64 Stück)

Lockable display Ø 6, 8, 10, 12 mm, shank 6 mm (64 pieces)

Film Movie



VALUETOOL

€ 726,68

neu

11 4856 U



BEST SELLER

Bestseller – preisreduziert  
Bestseller – price reduced



Universal HP-3



Zahnung Cut



BEST SELLER

Bestseller – preisreduziert  
Bestseller – price reduced

VALUETOOL

Valuetool – hervorragendes Preis-Leistungs-Verhältnis  
Valuetool – excellent price-performance ratio

Art.	d1	l2	d2	l1
11 5001 065	6	18	6	50
11 5001 080	8	20	6	65
11 5001 090	10	20	6	65
11 5001 105	12	25	6	70
11 5011 050	6	18	6	50
11 5011 075	8	20	6	65
11 5011 085	10	20	6	65
11 5011 100	12	25	6	70
11 5021 055	6	18	6	50
11 5021 075	8	20	6	65
11 5021 085	10	20	6	65
11 5021 105	12	25	6	70
11 5041 020	6	10	6	50
11 5041 025	8	15	6	60
11 5041 030	10	16	6	60
11 5041 035	12	22	6	67
11 5051 030	6	18	6	50
11 5051 035	8	20	6	65
11 5051 040	10	20	6	65
11 5051 050	12	25	6	70
11 5061 035	6	18	6	50
11 5061 040	8	20	6	65
11 5061 045	10	20	6	65
11 5061 060	12	25	6	70
11 5071 010	6	14	6	50
11 5071 015	8	20	6	65
11 5071 020	10	20	6	65
11 5071 025	12	32	6	77
11 5081 020	6	18	6	50
11 5081 025	8	25	6	70
11 5081 035	10	30	6	75
11 5081 045	12	32	6	77

Form Shape	DIN 8033	Inhalt   Contents
<b>A</b>	ZYA	2x Zylinder ohne Stirnverzahnung Cylinder without end cut
<b>B</b>	ZYB	2x Zylinder mit Stirnverzahnung Cylinder with end cut
<b>C</b>	WRC	2x Walzenrundform Ball nosed cylinder
<b>E</b>	TRE	2x Tropfen Oval
<b>F</b>	RBF	2x Rundbogen Ball nosed tree
<b>G</b>	SPG	2x Spitzbogen Tree
<b>H</b>	-	2x Flamme Flame
<b>L</b>	KEL	2x Rundkegel Ball nosed cone

Art. BESTSELLER	Art. VALUETOOL	d1	l2	d2	l1
11 3001 065	11 3001 066	6	18	6	50
11 3001 080	11 3001 081	8	20	6	65
11 3001 090	11 3001 091	10	20	6	65
11 3001 105	11 3001 108	12	25	6	70
11 3011 050	11 3011 051	6	18	6	50
11 3011 075	11 3011 076	8	20	6	65
11 3011 085	11 3011 086	10	20	6	65
11 3011 100	11 3011 104	12	25	6	70
11 3021 055	11 3021 054	6	18	6	50
11 3021 075	11 3021 076	8	20	6	65
11 3021 085	11 3021 086	10	20	6	65
11 3021 105	11 3021 108	12	25	6	70
11 3041 020	11 3041 021	6	10	6	50
11 3041 025	11 3041 026	8	15	6	60
11 3041 030	11 3041 031	10	16	6	60
11 3041 035	11 3041 036	12	22	6	67
			21		66
11 3051 030	11 3051 031	6	18	6	50
11 3051 035	11 3051 036	8	20	6	65
11 3051 040	11 3051 041	10	20	6	65
11 3051 050	11 3051 054	12	25	6	70
11 3061 035	11 3061 036	6	18	6	50
11 3061 040	11 3061 041	8	20	6	65
11 3061 045	11 3061 046	10	20	6	65
11 3061 060	11 3061 064	12	25	6	70
11 3071 010	11 3071 011	6	14	6	50
11 3071 015	11 3071 016	8	20	6	65
11 3071 020	11 3071 021	10	20	6	65
11 3071 025	11 3071 026	12	32	6	77
			30		75
11 3081 020	11 3081 021	6	18	6	50
11 3081 025	11 3081 026	8	25	6	70
11 3081 035	11 3081 031	10	30	6	75
			20		65
11 3081 045	11 3081 048	12	32	6	77
			25		70

Sie wollen einen anderen Inhalt? Kein Problem!  
Wählen Sie aus unserem Gesamtsortiment 6 mm Schäfte aus. Beachten Sie dabei die maximale Länge von 86 mm.

Would you like a display of mini-burrs? No problem!  
Select 6.0 mm shafts from the complete list of products.  
Note that the maximum length is 86 mm.



11 4948

Leeres Display / Empty display

€ 81,65



11 4955

Leeres Display / Empty display

€ 38,92



- 1
- 2
- 3
- 4
- 5
- 6
- 7
- 8
- 9
- 10

11 4904

BEST SELLER

€ 76,40



BEST SELLER

€ 58,45

11 4904 U



10 Stück  
10 pieces

Film  
Movie

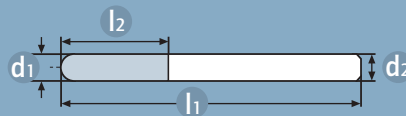

VALUETOOL

€ 40,45

neu  
new

11 4903 U

BEST SELLER

Bestseller – preisreduziert  
Bestseller – price reduced



### Universal HP-3



Zahnung  
Cut



BEST SELLER

Bestseller – preisreduziert  
Bestseller – price reduced



Valuetool – hervorragendes Preis-Leistungs-Verhältnis  
Valuetool – excellent price-performance ratio

Art.	d1	l2	d2	l1
11 5001 030	• 3	14	3	38
11 5011 015	• 3	14	3	38
11 5021 025	• 3	14	3	38
11 5031 025	• 3	2,7	3	38
11 5041 010	• 3	6	3	38
11 5051 015	• 3	14	3	38
11 5061 015	• 3	14	3	38
11 5071 005	• 3	6	3	38
11 5081 010	• 3	14	3	38
11 5091 015	• 3	11	3	38

Form Shape	DIN 8033	Inhalt   Contents
<b>A</b>	ZYA	1x Zylinder ohne Stirnverzahnung Cylinder without end cut
<b>B</b>	ZYB	1x Zylinder mit Stirnverzahnung Cylinder with end cut
<b>C</b>	WRC	1x Walzenrundform Ball nosed cylinder
<b>D</b>	KUD	1x Kugel Ball
<b>E</b>	TRE	1x Tropfen Oval
<b>F</b>	RBF	1x Rundbogen Ball nosed tree
<b>G</b>	SPG	1x Spitzbogen Tree
<b>H</b>	-	1x Flamme Flame
<b>L</b>	KEL	1x Rundkegel Ball nosed cone
<b>M</b>	SKM	1x Spitzkegel Cone

Art. BESTSELLER	Art. VALUETOOL	d1	l2	d2	l1
11 3001 030	11 3001 031	• 3	14	3	38
11 3011 015	11 3011 016	• 3	14	3	38
11 3021 025	11 3021 026	• 3	14	3	38
11 3031 025	11 3031 026	• 3	2,7 2,5	3	38
11 3041 010	11 3041 009	• 3	6	3	38
11 3051 015	11 3051 016	• 3	14	3	38
11 3061 015	11 3061 016	• 3	14	3	38
11 3071 005	11 3071 004	• 3	6	3	38
11 3081 010	11 3081 008	• 3	14	3	38
11 3091 015	11 3091 016	• 3	11	3	38

11 4952

Leeres Set /  
Empty set

€ 0,65



Sie wollen einen anderen Inhalt? Kein Problem! Wählen Sie aus unserem Gesamtsortiment 3 mm Schäfte aus. Beachten Sie dabei die maximale Länge von 38 mm.

Would you like a display of mini-burrs? No problem! Select 3.0 mm shafts from the complete list of products. Note that the maximum length is 38 mm.

11 4837

BEST SELLER

€ 381,05



BEST SELLER

€ 291,30

11 4837 U

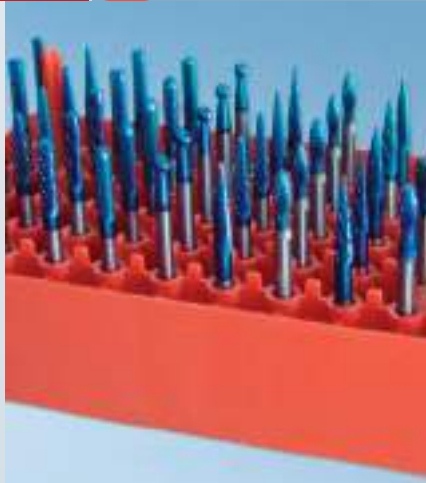

50 Stück  
50 pieces

Film  
Movie

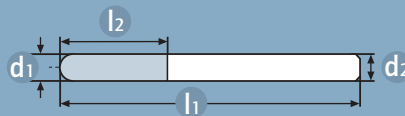

VALUETOOL € 201,30 **neu** 11 4838 U



BEST SELLER

Bestseller – preisreduziert  
Bestseller – price reduced



Universal HP-3



Zahnung  
Cut



BEST SELLER

Bestseller – preisreduziert  
Bestseller – price reduced



Valuetool – hervorragendes Preis-Leistungs-Verhältnis  
Valuetool – excellent price-performance ratio

Art.	d1	l2	d2	l1
11 5001 030	• 3	14	3	38
11 5011 015	• 3	14	3	38
11 5021 025	• 3	14	3	38
11 5031 025	• 3	2,7	3	38
11 5041 010	• 3	6	3	38
11 5051 015	• 3	14	3	38
11 5061 015	• 3	14	3	38
11 5071 005	• 3	6	3	38
11 5081 010	• 3	14	3	38
11 5091 015	• 3	11	3	38

Form Shape	DIN 8033	Inhalt   Contents
<b>A</b>	ZYA	5x Zylinder ohne Stirnverzahnung Cylinder without end cut
<b>B</b>	ZYB	5x Zylinder mit Stirnverzahnung Cylinder with end cut
<b>C</b>	WRC	5x Walzenrundform Ball nosed cylinder
<b>D</b>	KUD	5x Kugel Ball
<b>E</b>	TRE	5x Tropfen Oval
<b>F</b>	RBF	5x Rundbogen Ball nosed tree
<b>G</b>	SPG	5x Spitzbogen Tree
<b>H</b>	-	5x Flamme Flame
<b>L</b>	KEL	5x Rundkegel Ball nosed cone
<b>M</b>	SKM	5x Spitzkegel Cone

Art. BESTSELLER	Art. VALUETOOL	d1	l2	d2	l1
11 3001 030	11 3001 031	• 3	14	3	38
11 3011 015	11 3011 016	• 3	14	3	38
11 3021 025	11 3021 026	• 3	14	3	38
11 3031 025	11 3031 026	• 3	2,7 2,5	3	38
11 3041 010	11 3041 009	• 3	6	3	38
11 3051 015	11 3051 016	• 3	14	3	38
11 3061 015	11 3061 016	• 3	14	3	38
11 3071 005	11 3071 004	• 3	6	3	38
11 3081 010	11 3081 008	• 3	14	3	38
11 3091 015	11 3091 016	• 3	11	3	38

Sie wollen einen anderen Inhalt? Kein Problem! Wählen Sie aus unserem Gesamt-sortiment 3 mm Schäfte aus. Beachten Sie dabei die maximale Länge von 38 mm.

Would you like a display of mini-burrs? No problem! Select 3.0 mm shafts from the complete list of products. Note that the maximum length is 38 mm.



11 4953

Leeres Set /  
Empty set

€ 2,05



- 1
- 2
- 3
- 4
- 5
- 6
- 7
- 8
- 9
- 10

Index

- 1
- 2
- 3
- 4
- 5
- 6
- 7
- 8
- 9
- 10

11 4805

€ 130,65

**MINI**

10 Stück  
10 pieces

Film  
Movie



11 4805 U

€ 109,65

**MINI**



**Universal Fein**



Zahnung  
Cut



Art.	d1	l2	d2	l1
11 5006 005	• 1	4	3	38
11 5006 010	• 1,5	4	3	38
11 5026 005	• 1	4	3	38
11 5026 010	• 1,5	4	3	38
11 5036 005	• 1	1	3	38
11 5036 010	• 1,5	1	3	38
11 5046 005	• 1,5	4	3	38
11 5056 005	• 1,5	4	3	38
11 5066 005	• 1,5	4	3	38
11 5196 005	• 1,5	4	3	38

Form Shape	DIN 8033	Inhalt   Contents
<b>A</b>	ZYA	1x Zylinder ohne Stirnverzahnung Cylinder without end cut
<b>A</b>	ZYA	1x Zylinder ohne Stirnverzahnung Cylinder without end cut
<b>C</b>	WRC	1x Walzenrundform Ball nosed cylinder
<b>C</b>	WRC	1x Walzenrundform Ball nosed cylinder
<b>D</b>	KUD	1x Kugel Ball
<b>D</b>	KUD	1x Kugel Ball
<b>E</b>	TRE	1x Tropfen Oval
<b>F</b>	RBF	1x Rundbogen Ball nosed tree
<b>G</b>	SPG	1x Spitzbogen Tree
<b>M</b>	SKM	1x Spitzkegel Cone

Art.	d1	l2	d2	l1
11 3006 005	• 1	4	3	38
11 3006 010	• 1,5	4	3	38
11 3026 005	• 1	4	3	38
11 3026 010	• 1,5	4	3	38
11 3036 005	• 1	1	3	38
11 3036 010	• 1,5	1	3	38
11 3046 005	• 1,5	4	3	38
11 3056 005	• 1,5	4	3	38
11 3066 005	• 1,5	4	3	38
11 3196 005	• 1,5	4	3	38

11 4952

Leeres Set /  
Empty set

€ 0,65



Sie wollen einen anderen Inhalt an Mini-Frässtiften? Kein Problem! Wählen Sie aus dem Gesamtprogramm Mini-Frässtifte auf Seite 844 Ihren gewünschten Inhalt.

Would you like a display of mini-burrs? No problem! Select the content you want from the complete list of mini-burr products on page 844.

11 4820

€ 652,05

MINI



50 Stück  
50 pieces

Film  
Movie

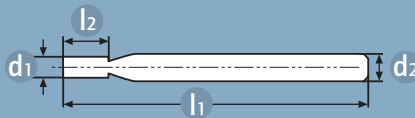

€ 547,05

11 4820 U

MINI



Universal Fein



Zahnung  
Cut



Art.	d1	l2	d2	l1
11 5006 005	• 1	4	3	38
11 5006 010	• 1,5	4	3	38
11 5006 020	• 2	4	3	38
11 5026 005	• 1	4	3	38
11 5026 010	• 1,5	1	3	38
11 5026 015	• 2	1	3	38
11 5036 005	• 1	4	3	38
11 5036 010	• 1,5	4	3	38
11 5036 015	• 2	4	3	38
11 5046 005	• 1,5	4	3	38
11 5056 005	• 1,5	4	3	38
11 5066 005	• 1,5	4	3	38
11 5196 005	• 1,5	4	3	38

Form Shape	DIN 8033	Inhalt   Contents
A	ZYA	5x Zylinder ohne Stirnverzahnung Cylinder without end cut
A	ZYA	5x Zylinder ohne Stirnverzahnung Cylinder without end cut
A	ZYA	3x Zylinder ohne Stirnverzahnung Cylinder without end cut
C	WRC	5x Walzenrundform Ball nosed cylinder
C	WRC	5x Walzenrundform Ball nosed cylinder
C	WRC	3x Walzenrundform Ball nosed cylinder
D	KUD	5x Kugel Ball
D	KUD	5x Kugel Ball
D	KUD	2x Kugel Ball
E	TRE	3x Tropfen Oval
F	RBF	3x Rundbogen Ball nosed tree
G	SPG	3x Spitzbogen Tree
M	SKM	3x Spitzkegel Cone

Art.	d1	l2	d2	l1
11 3006 005	• 1	4	3	38
11 3006 010	• 1,5	4	3	38
11 3006 020	• 1	4	3	38
11 3026 005	• 1,5	4	3	38
11 3026 010	• 1,5	4	3	38
11 3026 015	• 1,5	4	3	38
11 3036 005	• 1,5	4	3	38
11 3036 010	• 1	1	3	38
11 3036 015	• 1,5	1	3	38
11 3046 005	• 1,5	4	3	38
11 3056 005	• 1,5	4	3	38
11 3066 005	• 1,5	4	3	38
11 3196 005	• 1,5	4	3	38

Sie wollen einen anderen Inhalt an Mini-Frässtiften? Kein Problem! Wählen Sie aus dem Gesamtprogramm Mini-Frässtifte auf Seite 844 Ihren gewünschten Inhalt.

Would you like a display of mini-burrs? No problem! Select the content you want from the complete list of mini-burr products on page 844.

11 4953

Leeres Set /  
Empty set

€ 2,05



1



2



3



4



5



6



7



8



9



10



Index

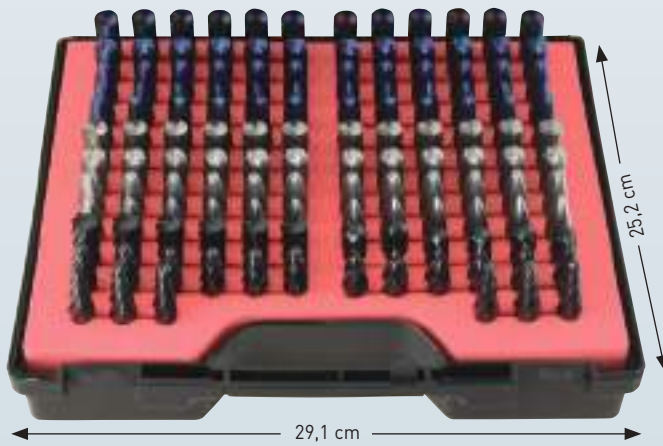

Deckel abnehmbar.  
Wird dadurch auch zu  
einem Tisch-Display.

Removable cover.  
Becomes a Display.



Kunststoffkoffer und Display  
leer. Zum selbst bestücken bis  
138 Stück.

Plastic case and display. Can  
be equipped with 138 pieces.

**Robuster Kunststoffkoffer mit Tragegriff und Display in einem.**

Ideal für den harten Einsatz auf der Baustelle.  
Alle Frässtifte gesichert von außen durch schlagfesten Kunststoff.  
Alle Frässtifte gesichert von innen durch festen Sitz in einer pass-  
genauen Bohrung. Die Köpfe können **nicht** aufeinanderschlagen.

Mit bis zu 138 Stück Frässtifte zu bestücken.  
Daher ebenfalls hervorragend geeignet als **Tisch-Display (Deckel  
abnehmbar)** oder Lagerung Ihrer gängigsten Frässtifte.

Wählen Sie aus unserem Gesamtsortiment Frässtifte mit Schaft  
6 oder 8 mm. Die Gesamtlänge (L1) des Frässtifts sollte 86 mm  
nicht überschreiten. **Wir beraten Sie gerne über die gängigsten  
Frässtifte.**

Bei Bestellung eines voll bestückten Koffers (138 Stück) ist der  
**Koffer gratis**. Sie bezahlen nur den Inhalt.

**Robust plastic case with carry handle and display in one.**

Ideal for hard use on the construction site.  
All rotary burrs secured from the outside by impact-resilient plastic.  
All rotary burrs secured from the inside by tight fit in a precisely  
fitting bore. The heads **cannot** touch.

Can be equipped with 138 rotary mills. It is also suitable as **table  
display (lid removable)** with our most popular rotary mills.

Choose rotary burrs with a 6 or 8 mm shaft from our overall rotary  
burrs range. The overall length (L1) of the rotary burr should not  
exceed 86 mm. **We will gladly advise you about the most common  
rotary burrs.**

When ordering a fully equipped case (138 pieces), the **case** is  
enclosed **for free**. You only need to pay for the contents.

- 1
- 2
- 3
- 4
- 5
- 6
- 7
- 8
- 9
- 10