

Turning solutions for cast iron

NC6310^{new} / NC6315

KORLOY
TECH-NEWS



- CVD coating with improved wear resistance and chipping resistance.
- Solutions for the most common issues in cast iron machining: Preventing excessive wear on rake and flank surfaces of insert, chipping and burr

CVD coated grade for high efficiency and quality turning of cast iron

NC6310 / NC6315 ^{new}

Cast iron is sorted into ductile cast iron and gray cast iron and commonly used in automobile and machinery components which require high heat resistance, corrosion resistance, and wear resistance. Cast iron embraces spheroidal carbide containing silicon (Si) and magnesium (Mg) so built-up edge and chipping can easily occur while machining. In contrast, gray cast iron includes acicular carbide so it produces better machining than ductile cast iron. However, cast iron workpiece is easily affected by manufacturing and external environment after casting process so its property is prone to be unstable.

Tool life of the existing CVD grades for cast iron turning is unstable due to the precarious property of workpieces causing rapid wear and chipping on the cutting edge. The unstable tool life is one of the worst obstacles of customer's high productivity so KORLOY focused on developing the technology of the CVD coating and chip breaker shape for stable and long

tool life and thus finally launched grades, NC6310 and NC6315 and chip breakers for customer's satisfaction

NC6310 is a K10 turning grade for high speed with continuous or light interrupted condition which enhances the wear resistance and stable tool life.

NC6315 is a K15 grade for general machining of gray cast iron and ductile cast iron and provides stable tool life in various kinds of machining such as high feed, heavy interrupted, or continuous cutting.

Chip breaker, **MK** (negative, for medium cutting) reduces cutting load and enhances surface finish. It is suitable for general machining. Chip breaker, **RK** (negative, for roughing) provides stable tool life even in heavy interrupted machining due to its strong rigidity of the cutting edge.

Both of MK and RK provide stable tool life even under any extreme cutting conditions due to unstable clamping of inserts and holders.



Minimized quality deviation of insert

- Stable tool life

Optimized cutting edge

- Improved surface finish

Superb combination of grades and chip breakers

- Extended tool life and enhanced cutting performance

Wide applications to various cast iron workpieces

- Specialized line-up of grades for continuous, high speed, heavy interrupted and high feed machining

Recommended machining range for each grade

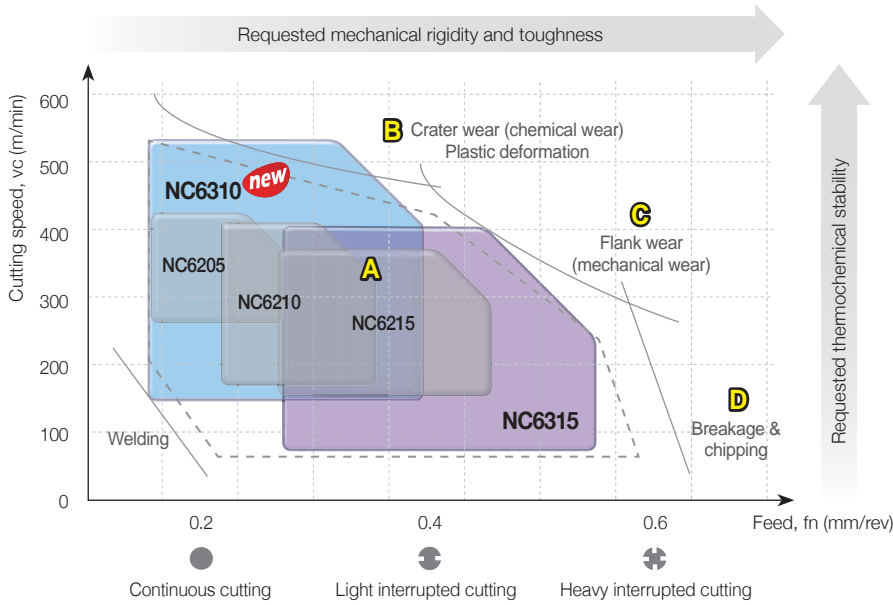

A	B	C	D
<ul style="list-style-type: none"> Gray/Ductile cast iron Continuous cutting at medium/high speed 	<ul style="list-style-type: none"> Gray cast iron (250/300) High speed cutting 	<ul style="list-style-type: none"> Ductile cast iron (higher than 600-3) Medium/high speed cutting 	<ul style="list-style-type: none"> Ductile cast iron (higher than 600-3) Heavy interrupted cutting
<p>Stable zone</p> <p>Normal wear</p>	<p>Crater wear (chemical wear)</p> <p>Plastic deformation on cutting edge</p>	<p>Flank wear (mechanical wear)</p>	<p>Chipping on cutting edge</p>

Recommended machining range for each chip breaker

※ -MA: A designation ends with '-MA' (None C/B)

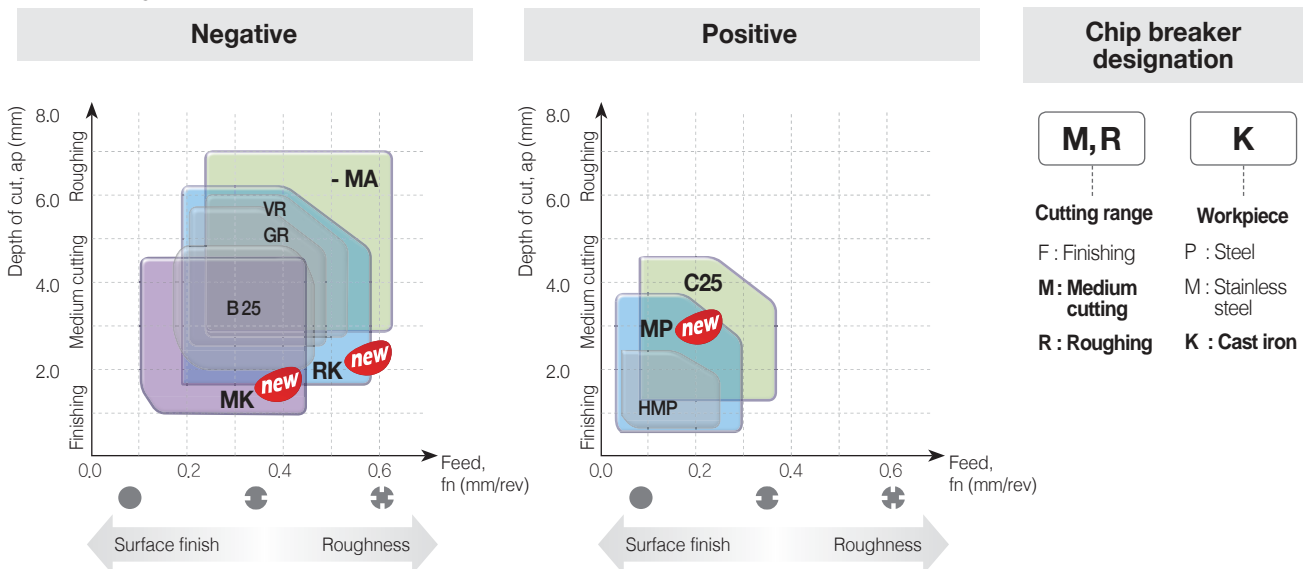

Features of grades

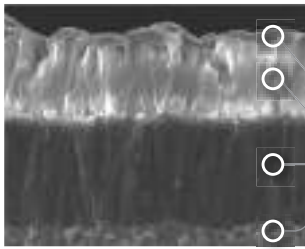

NC6310 ^{new}

- Titanium layer with excellent lubrication identifying wear
- Alumina layer specialized for heat resistance
- Titanium layer with improved fracture resistance
- Functional substrate optimized for high speed cast iron machining

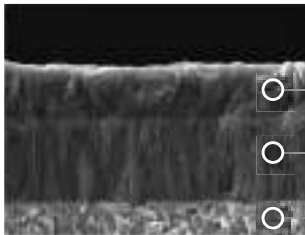
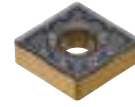

NC6315

- Alumina layer with better surface finish and improved wear resistance and welding resistance
- Titanium layer with improved fracture resistance
- Functional substrate optimized for high feed and heavy interrupted cast iron machining



Development effect

NC6310 ^{new}

[High speed/light interrupted cutting]

- **Workpiece** Ductile cast iron (500-7)
- **Workpiece use** Flywheel
- **Cutting conditions** vc (m/min) = 450, fn (mm/rev) = 0.3, ap (mm) = 2.5, dry, light interrupted cutting

► Improved wear resistance and fracture resistance on rake surface and nose radius



[NC6310]



[Existing grade (K10)]

NC6315

[Medium and high speed/heavy interrupted cutting]

- **Workpiece** Ductile cast iron (500-7)
- **Workpiece use** Diff case
- **Cutting conditions** vc (m/min) = 400, fn (mm/rev) = 0.3, ap (mm) = 2, wet, heavy interrupted cutting

► Improved flaking resistance and wear resistance on rake surface

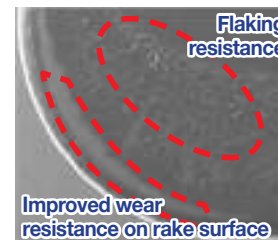

[NC6315]

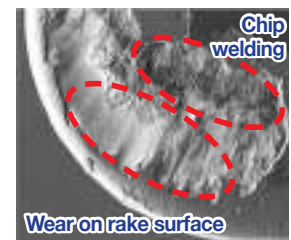

[Existing grade (K15)]

[Medium and high speed/High feed/heavy interrupted cutting]

- **Workpiece** Ductile cast iron (500-7)
- **Workpiece use** Knuckle
- **Cutting conditions** vc (m/min) = 200, fn (mm/rev) = 0.25, ap (mm) = 2, wet, heavy interrupted cutting

► Improved chipping resistance and wear resistance on flank surface



[NC6315]



[Existing grade (K15)]

Features of chip breakers

MK Chip breaker

- Optimized for continuous cutting of ductile cast iron and gray cast iron
- Sharp cutting edge improves surface finish.

Sharp Land

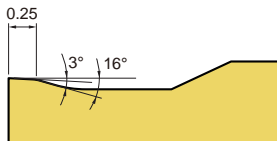

- Sharp cutting edge improves surface finish.
- Maximized wear resistance in continuous cutting
- Improved surface finish

Wide seating area

- Higher clamping stability
- Prevents chipping on cutting edge due to vibrations during operation

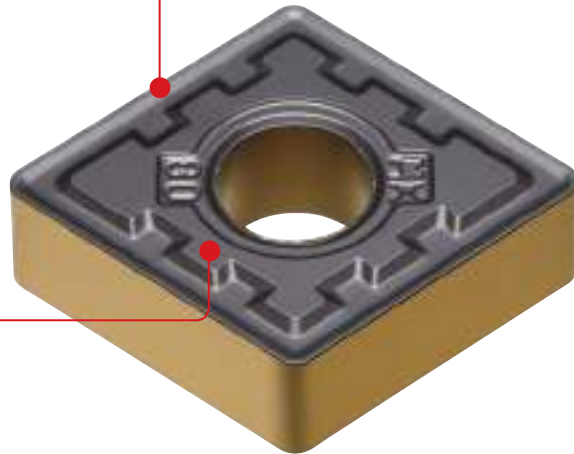

RK Chip breaker

- Optimized for high speed/ high feed cutting of ductile cast iron and gray cast iron
- Flat cutting edge provides upgraded toughness and chipping resistance.

Flat Land

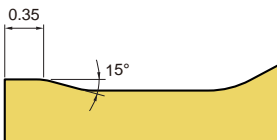

- Flat cutting edge improves toughness and chipping resistance.
- Stable machining even under cutting conditions with high cutting load with high depth of cut or interrupted cutting
- Ideal land width for high feed machining

Wide seating area

- Higher clamping stability
- Prevents chipping on cutting edge due to vibrations during operation

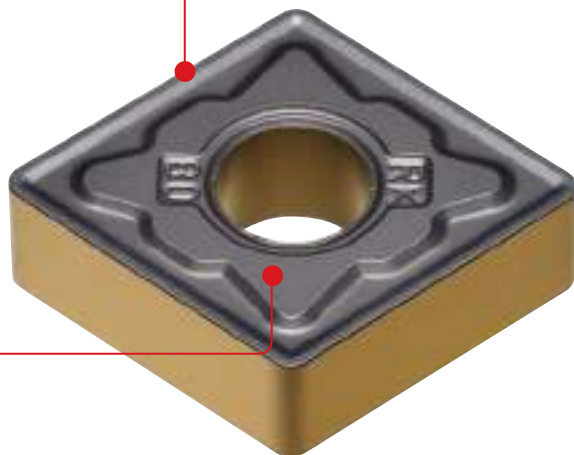

Recommended cutting conditions

Application	Chip breaker	Recommended cutting conditions					
		Depth of cut, a_p (mm)			Feed, f_n (mm/rev)		
		Min.	Recommended	Max.	Min.	Recommended	Max.
Medium cutting	MK	1	2.5	5	0.1	0.3	0.5
Roughing	RK	1.5	3	6	0.23	0.28	0.6

Application range

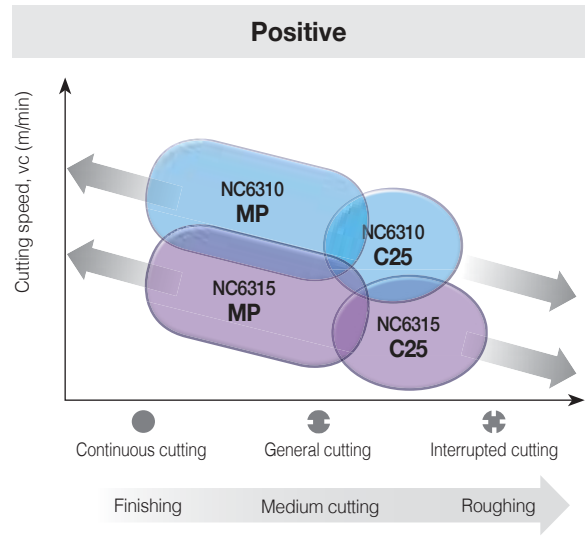
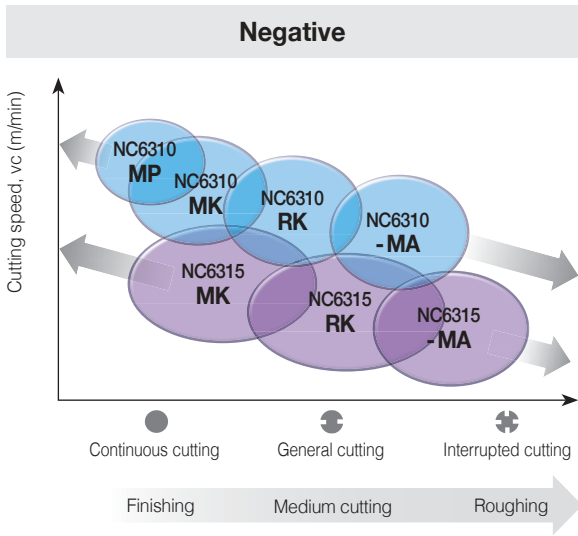

【Grade comparison】

ISO	KORLOY	Competitor A's	Competitor B's	Competitor C's	Competitor D's	Competitor E's	Competitor F's	Competitor G's
K05 - K10	new NC6310 (NC6205, NC6210)	TT7005	GC3210	CA4505 CA310	UC5105 MC5005	TK1001	WKK10S	AC405K AC4010K
K10 - K15	NC6315 (NC6215)	TT7015	GC3225	CA4515 CA315	UC5115 MC5015	TK2001	WKK20S	AC415K AC4015K

※ NC6200 series have been discontinued.

【Comparison of turning chip breakers for cast iron (Negative)】

Application	KORLOY	Competitor A's	Competitor B's	Competitor C's	Competitor D's	Competitor E's	Competitor F's	Competitor G's
Roughing	new RK, VR, GR	RT, KT	KR	KH	RK	MR7	-MA	GZ
Medium cutting	new MK, B25	MT	KM	KG	MK	M5	NM5	UZ
Finishing	new MK, MP	-	KF	KQ	LK	-	-	-

【Comparison of turning chip breakers for cast iron (Positive)】

Application	KORLOY	Competitor A's	Competitor B's	Competitor C's	Competitor D's	Competitor E's	Competitor F's	Competitor G's
Roughing	C25	-	KR	All round	-MW	-	-MW	-MW
Medium cutting	new MP	MT	KM	GK, HQ	MK	F2	PM5	MU
Finishing	new MP, HMP	-	KF	GK	LK	FK6	-	-

Cutting performance

Wear resistance test

- **Workpiece** Ductile cast iron (600-3, higher than 80-60-03, GCD600), Ø300 (Spherical tube) → Ø100, Facing
- **Cutting conditions** vc (m/min) = 400, f_n (mm/rev) = 0.35, a_p (mm) = 2.5, wet
- **Cutting pass** 10 passes with results of normal wear on rake and flank surface
- **Tools** Insert CNMA120408 (NC6310) Holder DCLNR2525-M12

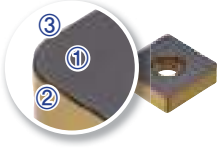

[NC6310]



[Existing grade]

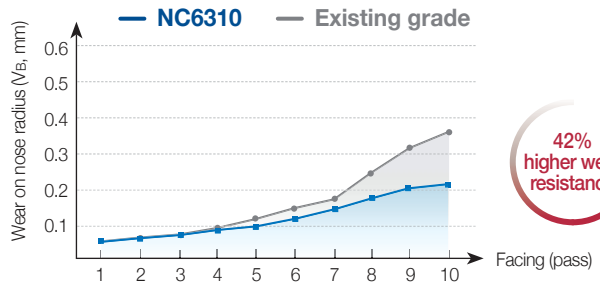

42% higher wear resistance

- Cast iron machining at high speed
- Wear on rake and flank surfaces, splintering cutting edge, fine chipping and notch chipping
- ↓
- Alumina coating layer with excellent wear resistance
- Decreased wear on rake and flank surfaces and fine chipping

Chipping resistance test

- **Workpiece** Ductile cast iron (500-7, 80-55-06, GCD500), Ø90 (Triangular tube) → Ø30, Facing
- **Cutting conditions** vc (m/min) = 380, f_n (mm/rev) = 0.35, a_p (mm) = 2, wet
- **Cutting pass** 15 passes with results of normal rake surface wear and good chipping resistance
- **Tools** Insert CNMG120408-RK (NC6315) Holder DCLNR2525-M12



[NC6315 (RK)]



[Existing grade]

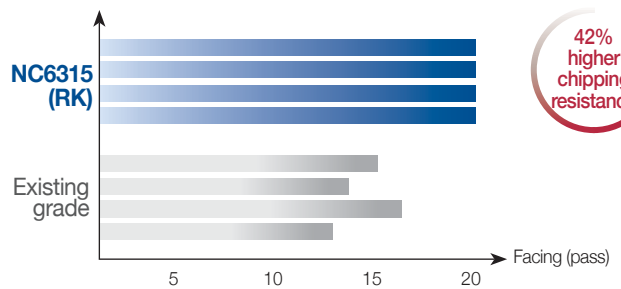

42% higher chipping resistance

- Built-up edge between tool and chip in heavy interrupted cast iron machining
- Flaking of coating layers on rake surface
- ↓
- Alumina coating layer with excellent wear resistance and welding resistance
- Superb chipping resistance
- Functional substrate with optimal hardness and toughness
- Improved tool life and tool stability

Application examples

Ductile cast iron (500-7)

- **Workpiece use** Flywheel
- **Cutting conditions** vc (m/min) = 450, n (rpm) = 550, fn (mm/rev) = 0.3, ap (mm) = 2, dry
- **Tools** **Insert** CNMA120412 (NC6310) **Holder** DCLNR2525

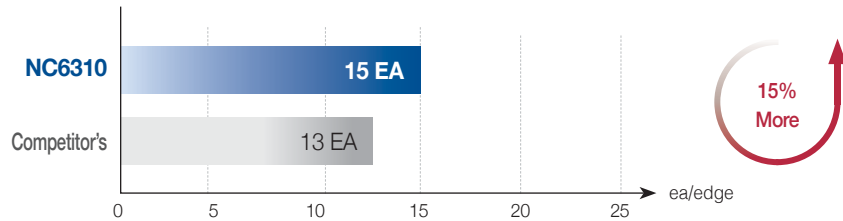

- Maintaining stable cutting performance with implementation of -MA type which features of wide clamping side and excellent edge strength.
- NC6310 applied alumina coating layer with heat resistance also improved wear resistance and surface finish on rake and flank surfaces in high speed, high feed and dry machining.

Gray cast iron (250)

- **Workpiece use** Disc brake
- **Cutting conditions** vc (m/min) = 550, n (rpm) = 547, fn (mm/rev) = 0.4, ap (mm) = 1, dry
- **Tools** **Insert** CNMG120412-RK (NC6310) **Holder** DCLNR2525

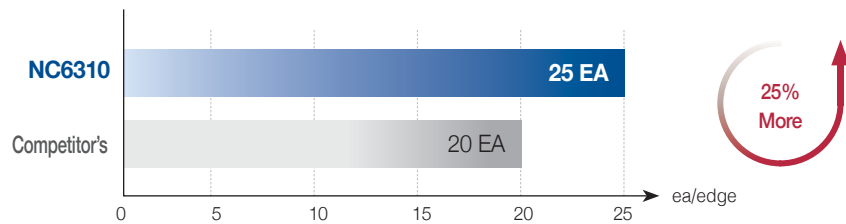

- Stable cutting performance with special edge design for high feed machining and implementation of RK chip breaker which has wide clamping side.
- NC6310 applied alumina coating layer with wear and oxidation resistance also improved wear resistance and excellent surface finish on rake and flank surfaces in high speed, high feed and dry machining.

Gray cast iron (250)

- **Workpiece use** Cylinder liner
- **Cutting conditions** vc (m/min) = 450, n (rpm) = 1100, fn (mm/rev) = 0.25, ap (mm) = 1.5, dry
- **Tools** **Insert** CNMA120408 (NC6310) **Holder** DCLNR2525

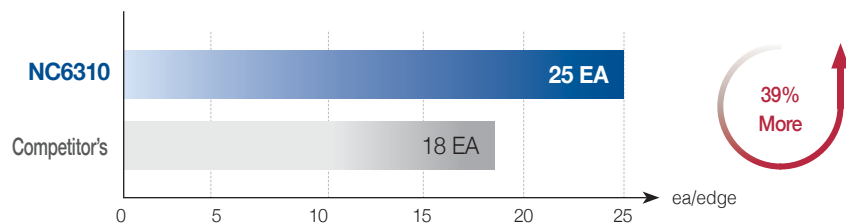

- Maintaining stable cutting performance with implementation of -MA type which features of wide clamping side and excellent edge strength.
- NC6310 applied alumina coating layer with wear resistance and oxidation resistance also improved wear resistance on flank surface and long tool life in high speed, medium feed and dry machining.

Application examples

Gray cast iron (300)

- **Workpiece use** Flywheel housing
- **Cutting conditions** vc (m/min) = 560, n (rpm) = 298, fn (mm/rev) = 0.3, ap (mm) = 1, wet
- **Tools** **Insert** CNMG120412-RK (NC6310) **Holder** DCLNR2525

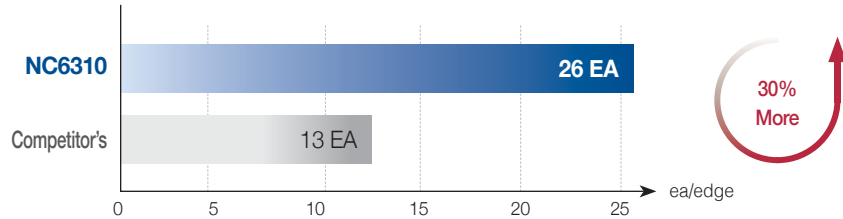

- Excellent performance in high feed machining with implementation of RK chip breaker that shows stable machinability.
- NC6310 applied alumina coating layer with wear and oxidation resistance and titanium coating layer with fracture resistance also improved wear and chipping resistance in high speed, high feed, medium interrupted and wet machining.

Ductile cast iron (500-7)

- **Workpiece use** Hub
- **Cutting conditions** vc (m/min) = 320, n (rpm) = 318, fn (mm/rev) = 0.4, ap (mm) = 2, wet
- **Tools** **Insert** WNMG080412-RK (NC6315) **Holder** DWLNR2525

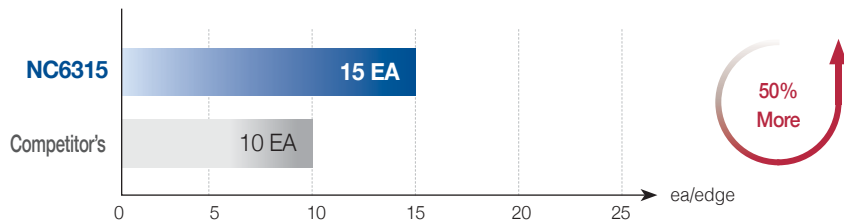

- Chip breaker, RK with high stability enhanced machinability in heavy interrupted and high feed machining.
- NC6315 shows improved wear resistance and chipping resistance in medium machining, high feed machining, heavy interrupted machining and wet condition by applying Alumina layer and Titanium coating layer with improved fracture resistance.

Ductile cast iron (500-7)

- **Workpiece use** Flywheel
- **Cutting conditions** vc (m/min) = 400, n (rpm) = 398, fn (mm/rev) = 0.3, ap (mm) = 2, wet
- **Tools** **Insert** CNMA120408 (NC6315) **Holder** DCLNR2525

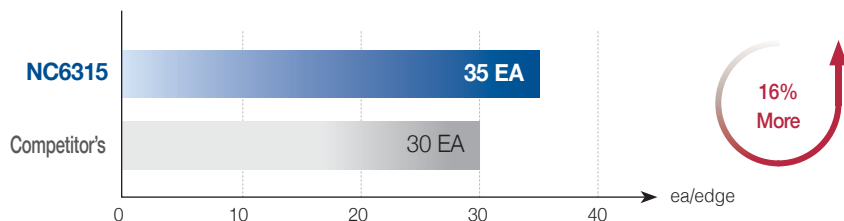

- Designation with '-MA' which refers for non-C/N applied shape with wide clamping side and hard cutting edge kept stable machinability.
- NC6315 shows improved surface roughness, wear resistance and chipping resistance in high speed machining, high feed machining, heavy interrupted machining and wet condition by applying Alumina layer and Titanium coating layer with improved fracture resistance.

Application examples

Ductile cast iron (700-2)

- **Workpiece use** Diff case transmission
- **Cutting conditions** vc (m/min) = 360, n (rpm) = 716, fn (mm/rev) = 0.25, ap (mm) = 1.5, wet
- **Tools** **Insert** CNMG120408-MK (NC6315) **Holder** DCLNR2525

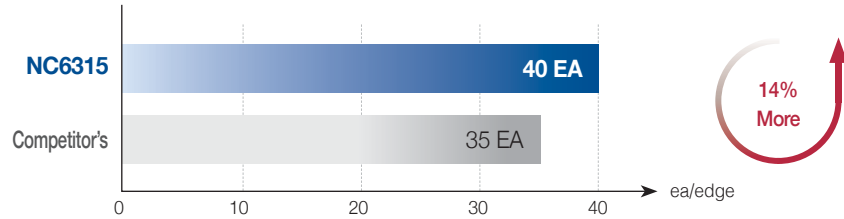

- MK chip breaker maximizes machining performance with its good machinability in ductile cast iron machining.
- NC6315 shows improved wear resistance and chipping resistance in medium and high speed machining, medium feed rate machining, heavy interrupted, machining and wet condition by applying Alumina layer and Titanium coating layer with improved fracture resistance.

Ductile cast iron (500-7)

- **Workpiece use** Knuckle
- **Cutting conditions** vc (m/min) = 200, n (rpm) = 1100, fn (mm/rev) = 0.25, ap (mm) = 2, wet
- **Tools** **Insert** DNMG150608-MK (NC6315) **Holder** DDJLNR2525

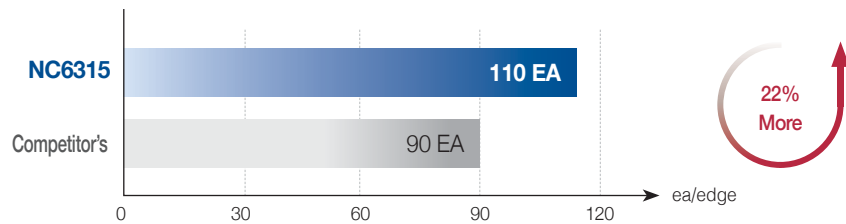

- MK chip breaker maximizes machining performance with its good machinability in ductile cast iron machining.
- NC6315 applied titanium coating layer with fracture resistance and functional substrate optimizing for high feed and heavy interrupted cast iron machining enhanced wear and chipping resistance in medium speed, medium feed, heavy interrupted and wet machining.

Recommended cutting conditions by workpieces (Negative)

Workpiece (ISO)	Tensile strength (N/mm ²)	Hardness (HB)	Application	Chip breaker	Depth of cut, ap (mm)	Feed, fn (mm/rev)	Cutting speed, vc (m/min)		
							NC6310	NC6315	
							Min - Recommended - Max	Min - Recommended - Max	
Ductile cast iron	500-7	≥ 500	170-241	Finishing	MK, MP	0.5 - 1.0 - 1.5	0.1 - 0.20 - 0.30	200 - 355 - 390	150 - 305 - 340
				Medium cutting	MK	1.0 - 2.0 - 3.5	0.2 - 0.35 - 0.45	200 - 350 - 385	150 - 300 - 335
				Roughing	RK, -MA	1.5 - 3.5 - 5.0	0.2 - 0.35 - 0.45	200 - 345 - 380	150 - 295 - 330
	600-3	≥ 600	192-269	Finishing	MK, MP	0.5 - 1.0 - 1.5	0.1 - 0.20 - 0.30	200 - 345 - 370	150 - 295 - 320
				Medium cutting	MK	1.0 - 2.0 - 3.5	0.2 - 0.35 - 0.45	200 - 340 - 365	150 - 290 - 315
				Roughing	RK, -MA	1.5 - 3.5 - 5.0	0.2 - 0.35 - 0.45	200 - 335 - 360	150 - 285 - 310
700-2	≥ 700	229-302	Finishing	MK, MP	0.5 - 1.0 - 1.5	0.1 - 0.20 - 0.30	200 - 340 - 360	150 - 290 - 310	
			Medium cutting	MK	1.0 - 2.0 - 3.5	0.2 - 0.30 - 0.40	200 - 335 - 355	150 - 285 - 305	
			Roughing	RK, -MA	1.5 - 3.0 - 4.0	0.2 - 0.30 - 0.40	200 - 330 - 350	150 - 280 - 300	
Gray cast iron	250	≥ 250	≤ 248	Finishing	MK, MP	0.5 - 1.0 - 1.5	0.1 - 0.20 - 0.30	200 - 395 - 430	150 - 345 - 380
				Medium cutting	MK	1.0 - 2.0 - 3.5	0.2 - 0.35 - 0.45	200 - 393 - 425	150 - 343 - 375
				Roughing	RK, -MA	1.5 - 3.5 - 5.0	0.2 - 0.35 - 0.45	200 - 390 - 420	150 - 340 - 370
	300	≥ 300	≤ 262	Finishing	MK, MP	0.5 - 1.0 - 1.5	0.1 - 0.20 - 0.30	200 - 390 - 420	150 - 340 - 370
				Medium cutting	MK	1.0 - 2.0 - 3.5	0.2 - 0.30 - 0.40	200 - 385 - 410	150 - 335 - 360
				Roughing	RK, -MA	1.5 - 3.5 - 5.0	0.2 - 0.30 - 0.40	200 - 380 - 400	150 - 330 - 350
	350	≥ 350	≤ 277	Finishing	MK, MP	0.5 - 1.0 - 1.5	0.1 - 0.20 - 0.30	200 - 380 - 400	150 - 330 - 350
				Medium cutting	MK	1.0 - 2.0 - 3.5	0.2 - 0.30 - 0.40	200 - 375 - 390	150 - 325 - 340
				Roughing	RK, -MA	1.5 - 3.5 - 5.0	0.2 - 0.30 - 0.40	200 - 375 - 390	150 - 330 - 340

※ Machining with NC6310 and NC6315 in the recommended cutting conditions above maximizes the tool life and productivity.

※ Recommend you to machine in optimal cutting conditions up to your machining environment.

Recommended cutting conditions by workpieces (Positive)

Workpiece (ISO)	Tensile strength (N/mm ²)	Hardness (HB)	Application	Chip breaker	Depth of cut, ap (mm)	Feed, fn (mm/rev)	Cutting speed, vc (m/min)		
							NC6310	NC6315	
							Min - Recommended - Max	Min - Recommended - Max	
Ductile cast iron	500-7	≥ 500	170-241	Finishing	MP, HMP	0.2 - 1.0 - 2.5	0.04 - 0.15 - 0.35	150 - 255 - 290	150 - 205 - 340
				Medium cutting	MP	0.5 - 1.5 - 3.5	0.04 - 0.20 - 0.40	150 - 250 - 285	150 - 200 - 335
				Roughing	C25	1.0 - 2.5 - 4.5	0.08 - 0.25 - 0.40	150 - 245 - 280	150 - 195 - 330
	600-3	≥ 600	192-269	Finishing	MP, HMP	0.2 - 1.0 - 2.5	0.04 - 0.15 - 0.35	150 - 245 - 270	150 - 195 - 320
				Medium cutting	MP	0.5 - 1.5 - 3.5	0.04 - 0.20 - 0.40	150 - 240 - 265	150 - 190 - 315
				Roughing	C25	1.0 - 2.5 - 4.5	0.08 - 0.25 - 0.40	150 - 235 - 260	150 - 185 - 310
700-2	≥ 700	229-302	Finishing	MP, HMP	0.2 - 1.0 - 2.5	0.04 - 0.10 - 0.25	150 - 240 - 260	150 - 190 - 310	
			Medium cutting	MP	0.5 - 1.5 - 3.5	0.04 - 0.15 - 0.35	150 - 235 - 255	150 - 185 - 305	
			Roughing	C25	1.0 - 2.5 - 4.5	0.08 - 0.20 - 0.35	150 - 230 - 250	150 - 180 - 300	
Gray cast iron	250	≥ 250	≤ 248	Finishing	MP, HMP	0.2 - 1.0 - 2.5	0.04 - 0.15 - 0.35	150 - 295 - 330	150 - 245 - 280
				Medium cutting	MP	0.5 - 1.5 - 3.5	0.04 - 0.20 - 0.40	150 - 293 - 325	150 - 243 - 275
				Roughing	C25	1.0 - 2.5 - 4.5	0.08 - 0.25 - 0.40	150 - 290 - 320	150 - 240 - 270
	300	≥ 300	≤ 262	Finishing	MP, HMP	0.2 - 1.0 - 2.5	0.04 - 0.15 - 0.35	150 - 290 - 320	150 - 240 - 270
				Medium cutting	MP	0.5 - 1.5 - 3.5	0.04 - 0.20 - 0.40	150 - 285 - 310	150 - 235 - 260
				Roughing	C25	1.0 - 2.5 - 4.5	0.08 - 0.25 - 0.40	150 - 280 - 300	150 - 230 - 250
	350	≥ 350	≤ 277	Finishing	MP, HMP	0.2 - 1.0 - 2.5	0.04 - 0.10 - 0.25	150 - 280 - 300	150 - 230 - 250
				Medium cutting	MP	0.5 - 1.5 - 3.5	0.04 - 0.15 - 0.35	150 - 275 - 290	150 - 225 - 240
				Roughing	C25	1.0 - 2.5 - 4.5	0.08 - 0.20 - 0.35	150 - 275 - 290	150 - 225 - 240

※ Machining with NC6310 and NC6315 in the recommended cutting conditions above maximizes the tool life and productivity.







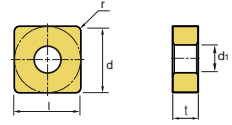
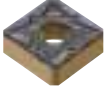
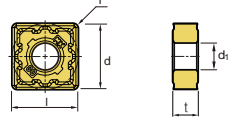
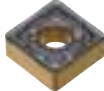
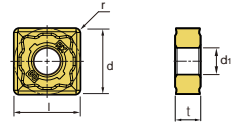

※ Recommend you to machine in optimal cutting conditions up to your machining environment.

Stock items (Negative)

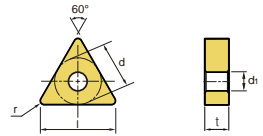
Type	Designation	Coated		Dimensions (mm)					Cutting conditions		Figure
		NC6310	NC6315	l	d	t	r	d1	fn (mm/rev)	ap (mm)	
	CNMA 120404	●	●	12.0	12.7	4.76	0.4	5.16	0.15-0.50	0.50-5.00	
	120408	●	●	12.0	12.7	4.76	0.8	5.16	0.15-0.60	1.00-6.00	
	120412	●	●	11.6	12.7	4.76	1.2	5.16	0.15-0.70	1.50-6.00	
	120416	●	●	11.3	12.7	4.76	1.6	5.16	0.20-0.80	2.00-6.00	
	160612	●	●	14.8	15.875	6.35	1.2	6.35	0.28-0.72	2.00-8.00	
	160616	●	●	14.4	15.875	6.35	1.6	6.35	0.28-0.74	2.00-8.00	
	190608	●	●	18.5	19.05	6.35	0.8	7.93	0.33-0.78	2.50-9.00	
	190612	●	●	18.1	19.05	6.35	1.2	7.93	0.35-0.78	2.60-9.50	
	190616	●	●	17.7	19.05	6.35	1.6	7.93	0.35-0.80	2.60-10.00	
	CNMG 120404-MP	●	●	12.4	12.7	4.76	0.4	5.16	0.05-0.30	0.90-4.00	
	120408-MP	●	●	12.0	12.7	4.76	0.8	5.16	0.10-0.50	1.00-5.00	
	120412-MP	●	●	11.6	12.7	4.76	1.2	5.16	0.13-0.60	1.30-5.00	
	CNMG 120404-MK	●	●	12.4	12.7	4.76	0.4	5.16	0.05-0.30	0.90-4.00	
	120408-MK	●	●	12.0	12.7	4.76	0.8	5.16	0.10-0.50	1.00-5.00	
	120412-MK	●	●	11.6	12.7	4.76	1.2	5.16	0.13-0.60	1.30-5.00	
	120416-MK	●	●	11.2	12.7	4.76	1.6	5.16	0.15-0.60	1.30-5.00	
	160608-MK	●	●	15.3	15.875	6.35	0.8	6.35	0.28-0.70	1.80-7.00	
	160612-MK	●	●	14.8	15.875	6.35	1.2	6.35	0.28-0.72	2.00-8.00	
	160616-MK	●	●	14.4	15.875	6.35	1.6	6.35	0.28-0.74	2.00-8.00	
	190608-MK	●	●	18.5	19.05	6.35	0.8	7.93	0.33-0.78	2.50-9.00	
	190612-MK	●	●	18.1	19.05	6.35	1.2	7.93	0.35-0.78	2.60-9.50	
	CNMG 120408-RK	●	●	12.0	12.7	4.76	0.8	5.16	0.20-0.50	1.50-6.00	
	120412-RK	●	●	11.6	12.7	4.76	1.2	5.16	0.28-0.53	1.80-6.00	
	120416-RK	●	●	11.3	12.7	4.76	1.6	5.16	0.28-0.63	2.00-6.00	
	160608-RK	●	●	15.3	15.875	6.35	0.8	6.35	0.28-0.70	1.80-7.00	
	160612-RK	●	●	14.8	15.875	6.35	1.2	6.35	0.28-0.72	2.00-8.00	
	160616-RK	●	●	14.4	15.875	6.35	1.6	6.35	0.28-0.74	2.00-8.00	
	190612-RK	●	●	18.1	19.05	6.35	1.2	7.93	0.35-0.78	2.60-9.50	
	190616-RK	●	●	17.7	19.05	6.35	1.6	7.93	0.35-0.80	2.60-10.00	
	DNMA 150412	●	●	14.4	12.7	4.76	1.5	5.16	0.13-0.60	1.30-4.00	
	150608	●	●	14.7	12.7	6.35	0.8	5.16	0.25-0.55	0.80-4.00	
	150612	●	●	14.4	12.7	6.35	1.2	5.16	0.25-0.65	1.20-4.00	
	DNMG 110408-MP	●	●	10.8	9.525	4.76	0.8	3.81	0.10-0.40	1.00-4.00	
	150604-MP	●	●	15.1	12.7	6.35	0.4	5.16	0.05-0.30	0.90-5.00	
	150608-MP	●	●	14.7	12.7	6.35	0.8	5.16	0.10-0.40	1.00-5.00	
	150612-MP	●	●	14.4	12.7	6.35	1.2	5.16	0.13-0.60	1.30-5.00	
	150616-MP	●	●	14.0	12.7	6.35	1.6	5.16	0.14-0.60	1.70-5.50	
	DNMG 150404-MK	●	●	15.1	12.7	4.76	0.4	5.16	0.05-0.30	0.90-5.00	
	150408-MK	●	●	14.7	12.7	4.76	0.8	5.16	0.10-0.50	1.00-5.00	
	150604-MK	●	●	15.1	12.7	6.35	0.4	5.16	0.05-0.30	0.90-5.00	
	150608-MK	●	●	14.7	12.7	6.35	0.8	5.16	0.10-0.20	1.00-5.00	
	150612-MK	●	●	14.4	12.7	6.35	1.2	5.16	0.13-0.60	1.30-5.00	
	DNMG 150412-RK	●	●	14.4	12.7	4.76	1.2	5.16	0.20-0.60	1.80-5.00	
	150608-RK	●	●	14.7	12.7	6.35	0.8	5.16	0.15-0.50	1.50-5.00	
	150612-RK	●	●	14.4	12.7	6.35	1.2	5.16	0.20-0.60	1.80-5.00	
	KNUX 160405R-11	●	●	19.2	9.525	4.76	0.5	2.2	0.20-0.35	1.00-6.00	

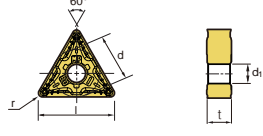

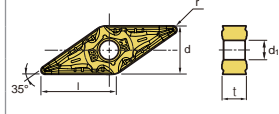

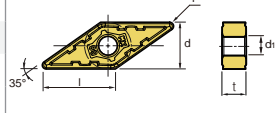

● : Stock item

Stock items (Negative)

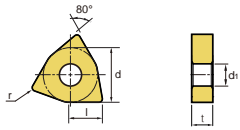
Type	Designation	Coated		Dimensions (mm)					Cutting conditions		Figure
		NC6310	NC6315	l	d	t	r	d1	fn (mm/rev)	ap (mm)	
	SNMA 120408	●		11.9	12.7	4.76	0.8	5.16	0.15-0.70	1.00-6.00	
	120412	●		11.5	12.7	4.76	1.2	5.16	0.20-0.80	1.50-6.00	
	120416	●		11.1	12.7	4.76	1.6	5.16	0.30-1.00	2.00-6.00	
	150616	●		14.2	15.875	6.35	1.6	6.35	0.25-1.00	2.00-8.00	
	190612	●		17.8	19.05	6.35	1.2	7.93	0.33-0.78	2.50-10.00	
	190616	●	●	17.4	19.05	6.35	1.6	7.93	0.35-0.78	2.70-10.00	
	SNMG 120404-MK			12.3	12.7	4.76	0.4	5.16	0.08-0.45	0.80-4.00	
	120408-MK	●		11.9	12.7	4.76	0.8	5.16	0.10-0.50	1.00-5.00	
	120412-MK	●		11.5	12.7	4.76	1.2	5.16	0.13-0.60	1.30-5.00	
	120416-MK			11.1	12.7	4.76	1.6	5.16	0.15-0.63	1.50-6.00	
	150612-MK			14.6	15.875	6.35	1.2	6.35	0.20-0.70	1.80-7.00	
	150616-MK			14.2	15.875	6.35	1.6	6.35	0.23-0.70	2.00-7.50	
	190608-MK			18.2	19.05	6.35	0.8	7.93	0.31-0.75	2.30-9.50	
	190612-MK	●		17.8	19.05	6.35	1.2	7.93	0.33-0.78	2.50-10.00	
	190616-MK			17.4	19.05	6.35	1.6	7.93	0.35-0.78	2.70-10.00	
	SNMG 120408-RK	●	●	11.9	12.7	4.76	0.8	5.16	0.23-0.53	1.50-6.00	
	120412-RK	●	●	11.5	12.7	4.76	1.2	5.16	0.28-0.53	1.80-6.00	
	120416-RK	●		11.1	12.7	4.76	1.6	5.16	0.28-0.53	2.00-6.00	
	150612-RK			14.6	15.875	6.35	1.2	6.35	0.20-0.70	1.80-7.00	
	150616-RK			14.2	15.875	6.35	1.6	6.35	0.23-0.70	2.00-7.50	
	190612-RK			17.8	19.05	6.35	1.2	7.93	0.33-0.78	2.50-10.00	
	TNMA 160404	●	●	15.5	9.525	4.76	0.4	3.81	0.05-0.30	0.50-3.50	
	160408	●	●	14.5	9.525	4.76	0.8	3.81	0.10-0.40	1.00-4.00	
	160412	●		13.5	9.525	4.76	1.2	3.81	0.10-0.50	1.50-4.50	
	160416	●		12.6	9.525	4.76	1.6	3.81	0.15-0.55	1.50-4.50	
	220408	●		20.0	12.7	4.76	0.8	5.16	0.15-0.40	1.50-5.00	
	220412	●		19.0	12.7	4.76	1.2	5.16	0.20-0.50	1.50-5.00	
	TNMG 160404-MP	●		15.5	9.525	4.76	0.4	3.81	0.05-0.30	0.90-3.50	
	TNMG 160404-MK	●	●	15.5	9.525	4.76	0.4	3.81	0.05-0.30	0.90-3.50	
	160408-MK	●		14.5	9.525	4.76	0.8	3.81	0.10-0.50	1.00-4.00	
	160412-MK	●		13.5	9.525	4.76	1.2	3.81	0.12-0.60	1.20-4.50	
	220408-MK			20.0	12.7	4.76	0.8	5.16	0.21-0.50	1.30-5.50	
	220412-MK			19.0	12.7	4.76	1.2	5.16	0.23-0.52	1.40-5.50	
	220416-MK			18.2	12.7	4.76	1.6	5.16	0.25-0.53	1.60-6.00	
	TNMG 160408-RK	●	●	14.5	9.525	4.76	0.8	3.81	0.23-0.53	1.50-5.00	
	160412-RK	●	●	13.5	9.525	4.76	1.2	3.81	0.28-0.53	1.80-5.00	
	160416-RK	●		12.6	9.525	4.76	1.6	3.81	0.28-0.53	1.80-5.00	
	VNMG 160404-MP			15.6	9.525	4.76	0.4	3.81	0.08-0.45	0.50-3.00	
	160408-MP	●		14.6	9.525	4.76	0.8	3.81	0.10-0.50	1.00-3.50	
	VNMG 160404-MK	●	●	15.6	9.525	4.76	0.4	3.81	0.08-0.45	0.50-3.00	
	160408-MK	●	●	14.6	9.525	4.76	0.8	3.81	0.10-0.50	1.00-3.50	
	160412-MK	●		13.1	9.525	4.76	1.2	3.81	0.20-0.50	1.50-4.00	

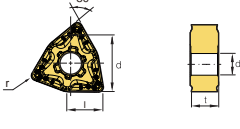

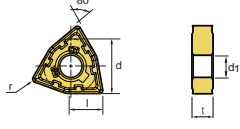

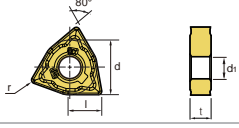
● : Stock item

Stock items (Negative)

Type	Designation	Coated		Dimensions (mm)					Cutting conditions		Figure
		NC6310	NC6315	l	d	t	r	d1	fn (mm/rev)	ap (mm)	
	WNMA 60408	●		6.1	9.525	4.76	0.8	3.81	0.08-0.30	0.80-2.50	
	60412			6.0	9.525	4.76	1.2	3.81	0.13-0.60	1.30-3.00	
	80404	●		8.4	12.7	4.76	0.4	5.16	0.15-0.60	1.00-5.00	
	80408	●		8.3	12.7	4.76	0.8	5.16	0.15-0.60	1.00-6.00	
	80412	●		8.2	12.7	4.76	1.2	5.16	0.15-0.70	1.50-6.00	
	80416			8.1	12.7	4.76	1.6	5.16	0.25-0.70	1.80-6.00	
	WNMG 060408-MP	●		6.1	9.525	4.76	0.8	3.81	0.08-0.30	0.80-2.50	
	080404-MP			8.4	12.7	4.76	0.4	5.16	0.10-0.45	1.00-3.00	
	080408-MP			8.3	12.7	4.76	0.8	5.16	0.10-0.50	1.00-3.50	
	080412-MP			8.2	12.7	4.76	1.2	5.16	0.10-0.50	1.00-4.00	
	080416-MP			8.1	12.7	4.76	1.6	5.16	0.13-0.50	1.20-4.20	
	WNMG 060408-MK	●	●	6.1	9.525	4.76	0.8	3.81	0.08-0.30	0.80-2.50	
	080404-MK	●		8.4	12.7	4.76	0.4	5.16	0.10-0.45	1.00-3.00	
	080408-MK	●		8.3	12.7	4.76	0.8	5.16	0.10-0.50	1.00-3.50	
	080412-MK	●		8.2	12.7	4.76	1.2	5.16	0.10-0.50	1.00-4.00	
	080416-MK			8.1	12.7	4.76	1.6	5.16	0.13-0.50	1.20-4.20	
	WNMG 080404-RK		●	8.4	12.7	4.76	0.4	5.16	0.23-0.50	1.50-6.00	
	080408-RK	●	●	8.3	12.7	4.76	0.8	5.16	0.23-0.53	1.50-6.00	
	080412-RK	●	●	8.2	12.7	4.76	1.2	5.16	0.28-0.53	1.80-6.00	
	080416-RK	●	●	7.9	12.7	4.76	1.6	5.16	0.25-0.60	2.00-6.00	

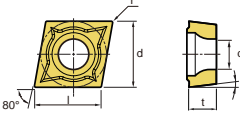
● : Stock item

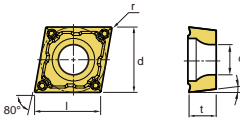

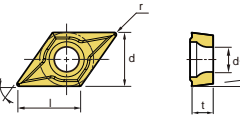







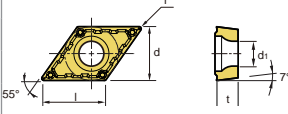



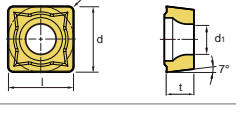

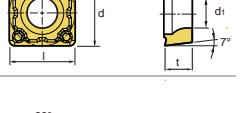
Stock items (Positive)

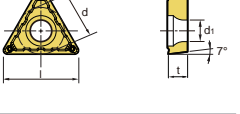
Type	Designation	Coated		Dimensions (mm)					Cutting conditions		Figure
		NC6310	NC6315	l	d	t	r	d1	fn (mm/rev)	ap (mm)	
	CCMT 060204-C25	●	●	6.0	6.35	2.38	0.4	2.8	0.05-0.15	0.60-2.30	
	060208-C25	●		6.0	6.35	2.38	0.8	2.8	0.08-0.18	1.00-2.50	
	09T304-C25	●	●	9.2	9.525	3.97	0.4	4.4	0.08-0.25	0.80-3.00	
	09T308-C25	●	●	8.8	9.525	3.97	0.8	4.4	0.10-0.30	1.00-3.00	
	120404-C25	●	●	12.5	12.7	4.76	0.4	5.5	0.10-0.32	0.80-3.00	
	120408-C25	●	●	12.1	12.7	4.76	0.8	5.5	0.12-0.36	1.00-3.50	
	120412-C25	●	●	12.1	12.7	4.76	1.2	5.5	0.12-0.36	1.40-3.80	
	CCMT 060204-MP	●		6.0	6.35	2.38	0.4	2.8	0.05-0.15	0.30-1.50	
	060208-MP	●		5.8	6.35	2.38	0.8	2.8	0.07-0.15	0.50-2.00	
	09T304-MP	●	●	9.2	9.525	3.97	0.4	4.4	0.08-0.25	0.50-2.50	
	09T308-MP	●	●	8.8	9.525	3.97	0.8	4.4	0.10-0.30	0.50-2.50	
	120404-MP	●	●	12.5	12.7	4.76	0.4	5.5	0.10-0.30	0.50-3.50	
	120408-MP	●	●	12.1	12.7	4.76	0.8	5.5	0.15-0.35	0.80-3.50	
	DCMT 070204-C25	●		7.3	6.35	2.38	0.4	2.8	0.06-0.17	0.50-2.30	
	070208-C25	●		7.3	6.35	2.38	0.8	2.8	0.08-0.23	1.00-2.30	
	11T302-C25			11.4	9.525	3.97	0.2	4.4	0.08-0.30	0.40-2.00	
	11T304-C25	●	●	11.2	9.525	3.97	0.4	4.4	0.08-0.30	0.80-3.00	
	11T308-C25	●	●	10.8	9.525	3.97	0.8	4.4	0.10-0.30	1.00-3.00	

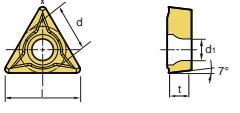
● : Stock item

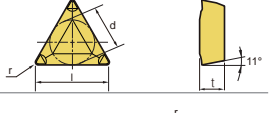
● : Stock item

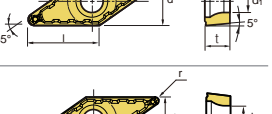
Stock items (Positive)

Type	Designation	Coated		Dimensions (mm)					Cutting conditions		Figure
		NC6310	NC6315	l	d	t	r	d1	fn (mm/rev)	ap (mm)	
	DCMT 070204-MP			7.3	6.35	2.38	0.4	2.8	0.06-0.17	0.20-2.30	
	11T304-MP	●	●	11.2	9.525	3.97	0.4	4.4	0.08-0.20	0.50-2.30	
	11T308-MP	●	●	10.8	9.525	3.97	0.8	4.4	0.10-0.30	0.50-2.30	
	RCMX 1003M0		●	-	10.0	3.18	-	3.6	0.25-0.50	1.50-4.00	
	1204M0		●	-	12.0	4.76	-	4.2	0.30-0.60	2.50-5.00	
	1606M0		●	-	16.0	6.35	-	5.2	0.40-0.70	3.00-7.00	
	2006M0		●	-	20.0	6.35	-	6.5	0.48-0.90	3.50-9.00	
	2507M0		●	-	25.0	7.94	-	7.25	0.55-1.20	4.00-12.00	
	3209M0		●	-	32.0	9.52	-	9.55	0.65-1.50	5.00-15.00	
	SCMT 09T304-C25		●	9.1	9.525	4.4	0.4	4.4	0.08-0.25	0.60-3.00	
	09T308-C25	●	●	8.7	9.525	4.4	0.8	4.4	0.10-0.30	1.00-3.00	
	120404-C25	●	●	12.3	12.7	5.5	0.4	5.5	0.10-0.35	0.80-3.00	
	120408-C25	●	●	11.9	12.7	5.5	0.8	5.5	0.12-0.38	1.20-3.80	
	SCMT 09T304-MP		●	9.1	9.525	4.4	0.4	4.4	0.05-0.25	0.30-2.80	
	09T308-MP	●	●	8.7	9.525	4.4	0.8	4.4	0.10-0.30	0.50-2.80	
	120408-MP	●	●	11.9	12.7	5.5	0.8	5.5	0.15-0.35	0.80-3.50	
	TCMT 090204-C25		●	8.6	5.56	2.38	0.4	2.5	0.06-0.18	0.40-2.50	
	090208-C25		●	7.6	5.56	2.38	0.8	2.5	0.08-0.25	0.80-2.50	
	110204-C25		●	10.0	6.35	2.38	0.4	2.8	0.06-0.20	0.60-2.50	
	110208-C25		●	9.0	6.35	2.38	0.8	2.8	0.08-0.25	0.80-2.50	
	16T304-C25		●	15.5	9.523	3.97	0.4	4.4	0.08-0.28	0.80-3.00	
	16T308-C25		●	14.5	9.523	3.97	0.8	4.4	0.10-0.30	1.00-3.00	
	TCMT 090208-MP			7.6	5.56	2.38	0.8	2.5	0.08-0.25	0.80-2.50	
	110204-MP			10.0	6.35	2.38	0.4	2.8	0.06-0.20	0.60-2.50	
	110208-MP			9.0	6.35	2.38	0.8	2.8	0.08-0.25	0.80-2.50	
	16T304-MP	●	●	15.5	9.523	3.97	0.4	4.4	0.08-0.20	0.30-2.50	
	16T308-MP	●	●	14.5	9.523	3.97	0.8	4.4	0.10-0.30	0.50-2.50	
	TPMR 110308-M		●	9.0	6.35	3.18	0.8	-	0.13-0.30	1.00-3.00	
	160304-M		●	15.5	9.525	3.18	0.4	-	0.10-0.25	1.00-5.00	
	160308-M		●	14.5	9.525	3.18	0.8	-	0.13-0.30	1.00-5.00	
	VBMT 160404-MP	●		15.6	9.525	4.76	0.4	4.4	0.08-0.18	0.30-2.00	
	160408-MP	●	●	14.6	9.525	4.76	0.8	4.4	0.10-0.23	0.50-2.30	
	VCMT 160404-MP		●	15.6	9.525	4.76	0.4	4.4	0.08-0.18	0.30-2.00	
	160408-MP		●	14.6	9.525	4.76	0.8	4.4	0.10-0.23	0.50-2.30	



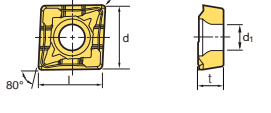

● : Stock item

Stock items (Multi Turn)

Type	Designation	Coated		Dimensions (mm)					Cutting conditions		Figure
		NC6310	NC6315	l	d	t	r	d1	fn (mm/rev)	ap (mm)	
	QCMT 050204-CM		●	5.0	5.4	2.1	0.4	2.3	0.05-0.17	0.50-2.80	
	060204-CM		●	6.0	6.4	2.38	0.4	2.5	0.06-0.18	0.60-3.20	
	070304-CM		●	7.0	7.4	3.18	0.4	2.8	0.08-0.19	0.80-3.50	
	080304-CM		●	8.0	8.4	3.18	0.4	3.4	0.09-0.23	0.90-3.90	
	170508-CM		●	16.7	17.5	5.56	0.8	5.5	0.17-0.35	2.00-5.00	

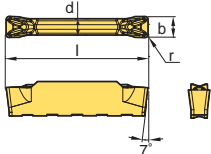
● : Stock item

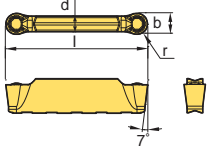
Stock items (KGT, MGT)

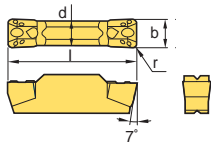
Type	Designation	Coated		Dimensions (mm)					Cutting conditions		Figure
		NC6310	NC6315	b	r	l	d	α°	fn (mm/rev)	ap (mm)	
	KGMN 150-015-T	●		1.5	0.15	16	1.2	-	0.02-0.10	-	
	200-02-T	●		2.0	0.2	20	1.7	-	0.05-0.12	-	
	300-02-T	●		3.0	0.2	20	2.3	-	0.05-0.12	-	
	300-04-T	●		3.0	0.4	20	2.3	-	0.05-0.15	-	
	400-04-T	●		4.0	0.4	20	3.3	-	0.07-0.18	-	
	400-08-T	●		4.0	0.8	20	3.3	-	0.07-0.20	-	
	500-04-T	●		5.0	0.4	25	4.1	-	0.10-0.18	-	
	500-08-T	●		5.0	0.8	25	4.1	-	0.10-0.22	-	
	600-04-T	●		6.0	0.4	25	5.1	-	0.10-0.20	-	
	600-08-T	●		6.0	0.8	25	5.1	-	0.10-0.24	-	
	800-08-T	●		8.0	0.8	30	6.1	-	0.12-0.24	-	
	KRMN 200-C	●		2.0	1.0	20	1.7	-	0.03-0.13	-	
	300-C			3.0	1.5	20	2.2	-	0.03-0.15	-	
	400-C	●		4.0	2.0	20	3.2	-	0.10-0.25	-	
	500-C	●		5.0	2.5	25	4.0	-	0.10-0.25	-	
	600-C	●		6.0	3.0	25	5.0	-	0.10-0.25	-	
	800-C	●		8.0	4.0	30	6.0	-	0.10-0.25	-	
	MGMN 300-M	●		3.0	0.2	21	2.35	-	0.05-0.12	-	
	400-M	●		4.0	0.4	21	3.3	-	0.07-0.18	-	
	500-M	●		5.0	0.8	26	4.1	-	0.10-0.18	-	
	600-M	●		6.0	0.8	26	5.0	-	0.10-0.20	-	

● : Stock item



Holystar B/D, 1350, Nambusunhwan-ro, Geumcheon-gu, Seoul, 08536, Korea

Tel : +82-2-522-3181 Fax : +82-2-522-3184, +82-2-3474-4744 Web : www.korloy.com E-mail : export@korloy.com

KORLOY AMERICA

620 Maple Avenue, Torrance, CA 90503, USA

Tel : +1-310-782-3800 Toll Free : +1-888-711-0001 Fax : +1-310-782-3885

E-mail : sales.kai@korloy.com

KORLOY INDIA

Plot No. 415, Sector 8, IMT Manesar, Gurgaon 122051, Haryana, India

Tel : +91-124-4391790 Fax : +91-124-4050032

E-mail : sales.kip@korloy.com

KORLOY VIETNAM

Lot B1, Thinh Gia Housing and Urban Development Area, Tan Dinh Ward, Ben Cat Town, Binh Duong Province, Vietnam

Tel : +84-96-856-1230 E-mail : sales.kvc@korloy.com

KORLOY CHILE

Av. Providencia 1650, Office 1009, 7500027

Providencia-Santiago, Chile

Tel : +56-229-295-490 E-mail : sales.kcs@korloy.com

KORLOY FACTORY QINGDAO

Ground Dongjing Road 56(B) District Free Trade Zone. Qingdao, China

Tel : +86-532-86959880 Fax : +86-532-86760651

E-mail : pro.kfq@korloy.com

KORLOY EUROPE

Gablonzer Str. 25-27, 61440 Oberursel, Germany

Tel : +49-6171-277-83-0 Fax : +49-6171-277-83-59

E-mail : sales.keg@korloy.com

KORLOY BRASIL

Av. Aruana 280, conj.12, WLC, Alphaville, Barueri,

CEP06460-010, SP, Brasil

Tel : +55-11-4193-3810 E-mail : sales.kbl@korloy.com

KORLOY TURKEY

Orucreis Mah. Vadi Cad. No: 108 Istanbul Ticaret Sarayi

Kat 5 No: 318 Giyimkent Sitesi-Esenler/Istanbul, Turkey

Tel : +90-212-438-5197 E-mail : service@korloy.com.tr

KORLOY FACTORY INDIA

Plot No. 415, Sector 8, IMT Manesar, Gurgaon 122051, Haryana, India

Tel : +91-124-4391790 Fax : +91-124-4050032

E-mail : pro.kim@korloy.com