

Kanal Kater
Grooving Holders
Stech-Klemmhalter

TEKNIK
Cutting Tools



www.teknikcuttingtools.com



Kalite için TEKNİK çözüm
Technical solution for quality



KRLY-R

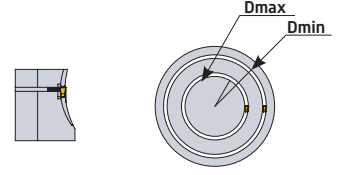
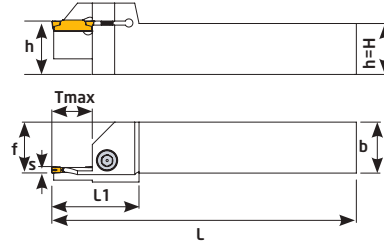

Sipariş Kodu Order Code Best.-Nr.	Stok/Stock/Lager	Ürün Kodu Product Code Produkt-Code	Ölçüler (mm) Dimensions(mm) Abmessungen (mm)										Kullanılan Uç Insert WSP	Sıkma Civatası Clamp Screw Inbuss-Schraube	Anahtar Allen Key Inbuss-Schlüssel
			Dmin	Dmax	S	Tmax	f	b	h=H	L	L1	kg			
D780	●	2525 3C-R (50-60)	50	60	3	17	25	25	25	150	40	0,741	MGM 3 KRLY	TC134 M6x20	5 Allen
D782	●	2525 3C-R (60-80)	60	80	3	17	25	25	25	150	40	0,717			
D784	●	2525 3C-R (80-110)	80	110	3	17	25	25	25	150	40	0,720			
D785	●	2525 3C-R (110-150)	110	150	3	17	25	25	25	150	40	0,730			
D786	●	2525 4C-R (50-60)	50	60	4	20	25	25	25	150	45	0,704			
D788	●	2525 4C-R (60-80)	60	80	4	20	25	25	25	150	45	0,712			
D790	●	2525 4C-R (80-110)	80	110	4	20	25	25	25	150	45	0,701			
D791	●	2525 4C-R (110-150)	110	150	4	20	25	25	25	150	45	0,712			
D791-1	●	2525 4C (140-600)	140	600	4	25	25	25	25	150	49	0,667			
D792	●	2525 5C-R (50-80)	50	80	5	20	25	25	25	150	45	0,721			
D796	●	2525 5C-R (80-110)	80	110	5	20	25	25	25	150	45	0,716			
D798	●	2525 5C-R (110-150)	110	150	5	20	25	25	25	150	45	0,718			
D799	●	2525 5C-R (140-350)	140	350	5	20	25	25	25	150	45	0,675			
D799-1	●	2525 5C-R (350-500)	350	500	5	20	25	25	25	150	45	0,713			
D799-2	●	2525 5C-R (140-600)	140	600	5	25	25	25	25	150	49	0,664			

KRLY-L

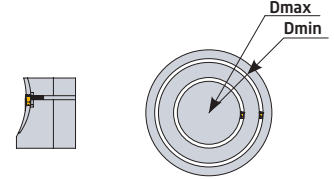
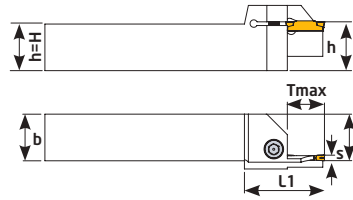

Sipariş Kodu Order Code Best.-Nr.	Stok/Stock/Lager	Ürün Kodu Product Code Produkt-Code	Ölçüler (mm) Dimensions(mm) Abmessungen (mm)										Kullanılan Uç Insert WSP	Sıkma Civatası Clamp Screw Inbuss-Schraube	Anahtar Allen Key Inbuss-Schlüssel
			Dmin	Dmax	S	Tmax	f	b	h=H	L	L1	kg			
D800	●	2525 3C-L (50-60)	50	60	3	17	25	25	25	150	40	0,741	MGM 3 KRLY	TC134 M6x20	5 Allen
D802	●	2525 3C-L (60-80)	60	80	3	17	25	25	25	150	40	0,717			
D804	●	2525 3C-L (80-110)	80	110	3	17	25	25	25	150	40	0,720			
D805	●	2525 3C-L (110-150)	110	150	3	17	25	25	25	150	40	0,730			
D806	●	2525 4C-L (50-60)	50	60	4	20	25	25	25	150	45	0,704			
D808	●	2525 4C-L (60-80)	60	80	4	20	25	25	25	150	45	0,712			
D810	●	2525 4C-L (80-110)	80	110	4	20	25	25	25	150	45	0,700			
D811	●	2525 4C-L (110-150)	110	150	4	20	25	25	25	150	45	0,712			
D811-1	●	2525 4C-L (140-600)	140	600	4	25	25	25	25	150	49	0,667			
D812	●	2525 5C-L (50-80)	50	80	5	20	25	25	25	150	45	0,721			
D816	●	2525 5C-L (80-110)	80	110	5	20	25	25	25	150	45	0,716			
D818	●	2525 5C-L (110-150)	110	150	5	20	25	25	25	150	45	0,718			
D819	●	2525 5C-L (140-600)	140	600	5	25	25	25	25	150	49	0,664			
D819-1	●	2525 5C-L (350-500)	350	500	5	20	25	25	25	150	45	0,713			

KRLY ucuna uygundur. / Compatible with KRLY insert. / Kompatible für KRLY WP

MGM /R

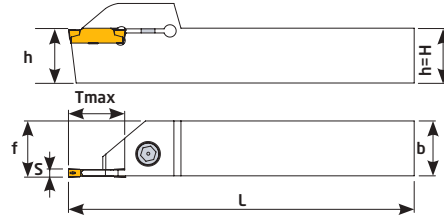

Sipariş Kodu Order Code Best.-Nr.	Stok/Stock/Lager	Ürün Kodu Product Code Produkt-Code	Ölçüler (mm) Dimensions(mm) Abmessungen (mm)							Kullanılan Uç Insert WSP	Sıkma Civatası Clamp Screw Inbuss-Schraube	Anahtar Allen Key Inbuss-Schlüssel
			h=H	b	S	Tmax	f	L				
D658	●	1212 2C-R MGM	12	12	2	16	12	125	0,162	2C MGM KRLY	TC131 M5x16	4 Allen
D660	●	1616 2C-R MGM	16	16	2	16	16	125	0,250			
D662	●	2020 2C-R MGM	20	20	2	16	20	125	0,404		TC132 M5x20	5 Allen
D664	●	2525 2C-R MGM	25	25	2	16	25	150	0,726			
D666	●	3232 2C-R MGM	32	32	2	16	32	170	1,349	3C MGM KRLY	TC131 M5x16	4 Allen
D667	●	1212 3C-R MGM	12	12	3	18	12	125	0,162			
D668	●	1616 3C-R MGM	16	16	3	18	16	125	0,268		TC132 M5x20	5 Allen
D670	●	2020 3C-R MGM	20	20	3	18	20	125	0,407			
D672	●	2525 3C-R MGM	25	25	3	18	25	150	0,727	4C MGM KRLY	TC134 M6x20	5 Allen
D674	●	3232 3C-R MGM	32	32	3	20	32	170	1,280			
D675	●	1616 4C-R MGM	16	16	4	18	16	125	0,273		TC131 M5x16	4 Allen
D676	●	2020 4C-R MGM	20	20	4	18	20	125	0,408			
D678	●	2525 4C-R MGM	25	25	4	18	25	150	0,727	5C MGM KRLY	TC132 M5x20	4 Allen
D680	●	3232 4C-R MGM	32	32	4	20	32	170	1,287			
D682	●	2020 5C-R MGM	20	20	5	25	20	125	0,391		TC134 M6x20	5 Allen
D684	●	2525 5C-R MGM	25	25	5	25	25	150	0,703			
D686	●	3232 5C-R MGM	32	32	5	25	32	170	1,268	TC136 M8x20	6 Allen	
D687	●	2525 6C-R MGM	25	25	6	27	25	150	0,745			6C MGM KRLY

MGM /R

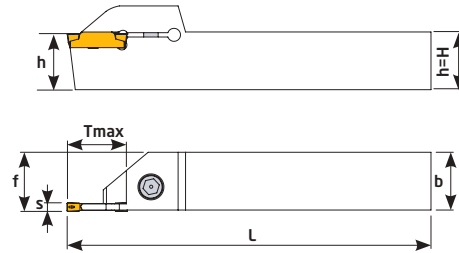

Sipariş Kodu Order Code Best.-Nr.	Stok/Stock/Lager	Ürün Kodu Product Code Produkt-Code	Ölçüler (mm) Dimensions(mm) Abmessungen (mm)							Kullanılan Uç Insert WSP	Sıkma Civatası Clamp Screw Inbuss-Schraube	Anahtar Allen Key Inbuss-Schlüssel
			h=H	b	S	Tmax	f	L				
D960	●	2525 3C-R MGM	25	25	3	25	25	150	0,727	3C MGM KRLY	TC134 M6x20	5 Allen
D963	●	2525 3C-R MGM	25	25	3	40	25	170	0,722			
D961	●	2525 4C-R MGM	25	25	4	25	25	150	0,727	4C MGM KRLY		
D964	●	2525 4C-R MGM	25	25	4	40	25	170	0,721			
D962	●	2525 5C-R MGM	25	25	5	40	25	170	0,745	5C MGM KRLY		

KRLY ucuna uygundur. / Compatible with KRLY insert. / Kompatibel für KRLY WP

● Stokta/ In Stock/ Lager ○ Sınırlı Stok/ Limited Stock/ Begrenzte Lagerhaltung

MGM /L

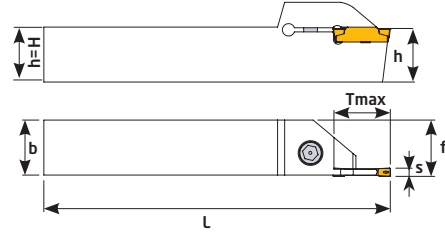

Sipariş Kodu Order Code Best.-Nr.	Stok/Stock/Lager	Ürün Kodu Product Code Produkt-Code	Ölçüler (mm) Dimensions(mm) Abmessungen (mm)							Kullanılan Uç Insert WSP	Sıkma Civatası Clamp Screw Inbuss-Schraube	Anahtar Allen Key Inbuss-Schlüssel
			h=H	b	S	Tmax	f	L	kg			
D607	●	1212 2C-L MGM	12	12	2	16	12	125	0,161	2C MGM KRLY	TC131 M5x16	4 Allen
D608	●	1616 2C-L MGM	16	16	2	16	16	125	0,250		TC132 M5x20	
D610	●	2020 2C-L MGM	20	20	2	16	20	125	0,404		TC134 M6x20	5 Allen
D612	●	1616 3C-L MGM	16	16	3	18	16	125	0,268	3C MGM KRLY	TC131 M5x16	4 Allen
D614	●	2020 3C-L MGM	20	20	3	18	20	125	0,407		TC132 M5x20	
D615	●	2525 3C-L MGM	25	25	3	18	25	150	0,750		TC134 M6x20	5 Allen
D617	●	2020 4C-L MGM	20	20	4	18	20	125	0,407	4C MGM KRLY	TC132 M5x20	4 Allen
D618	●	2525 4C-L MGM	25	25	4	18	25	150	0,727	5C MGM KRLY	TC134 M6x20	5 Allen
D620	●	2525 5C-L MGM	25	25	5	25	25	150	0,703			
D621	●	2525 6C-L MGM	25	25	5	27	25	150	0,745			

KGMN /R

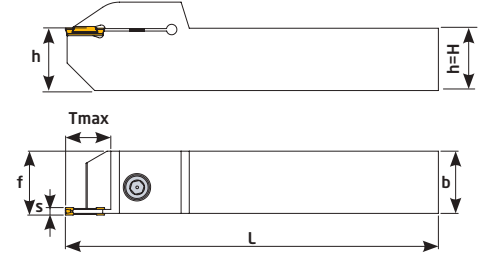

Sipariş Kodu Order Code Best.-Nr.	Stok/Stock/Lager	Ürün Kodu Product Code Produkt-Code	Ölçüler (mm) Dimensions(mm) Abmessungen (mm)							Kullanılan Uç Insert WSP	Sıkma Civatası Clamp Screw Inbuss-Schraube	Anahtar Allen Key Inbuss-Schlüssel
			h=H	b	S	Tmax	f	L	kg			
D635	●	2020 2C-R KGMN	20	20	2	18	20	125	0,412	2C KGMN KRLY	TC132 M5x20	4 Allen
D636	●	2525 2C-R KGMN	25	25	2	18	25	150	0,726		TC134 M6x20	5 Allen
D637	●	2020 3C-R KGMN	20	20	3	20	20	125	0,406	3C KGMN KRLY	TC132 M5x20	4 Allen
D638	●	2525 3C-R KGMN	25	25	3	22	25	150	0,732		TC134 M6x20	5 Allen
D639	●	2020 4C-R KGMN	20	20	4	20	20	125	0,406	4C KGMN KRLY	TC132 M5x20	4 Allen
D640	●	2525 4C-R KGMN	25	25	4	22	25	152	0,737		TC134 M6x20	5 Allen

KRLY ucuna uygundur. / Compatible with KRLY insert. / Kompatibel für KRLY WP

KGEVR-KGMN

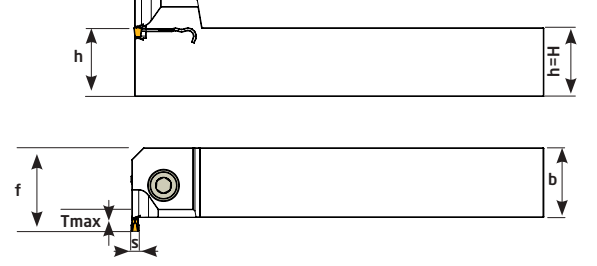

Sipariş Kodu Order Code Best.-Nr.	Stok/Stock/Lager	Ürün Kodu Product Code Produkt-Code	Ölçüler (mm) Dimensions(mm) Abmessungen (mm)								Kullanılan Uç Insert WSP	Sıkma Civatası Clamp Screw Inbuss-Schraube	Anahtar Allen Key Inbuss-Schlüssel
			Dmin	h=H	b	S	Tmax	f	L				
D622	●	2020 2C KGEVR-KGMN	120	20	20	2	3,5	23,5	125	0,412	KGEVR-KGMN 200 KRLY	TC132 M5x20	4 Allen
D623	●	2525 2C KGEVR-KGMN	80	25	25	2	3,5	28,5	150	0,833			
D624	●	2020 3C KGEVR-KGMN	120	20	20	3	5	25	125	0,468	KGEVR-KGMN 300 KRLY	TC132 M5x20	4 Allen
D625	●	2525 3C KGEVR-KGMN	80	25	25	3	5	30	150	0,837			
D626	●	2020 4C KGEVR-KGMN	120	20	20	4	5	25	125	0,463	KGEVR-KGMN 400 KRLY	TC132 M5x20	4 Allen
D627	●	2525 4C KGEVR-KGMN	80	25	25	4	5	30	150	0,464			

KRLY ucuna uygundur. / Compatible with KRLY insert. / Kompatible für KRLY WP

GRP /R

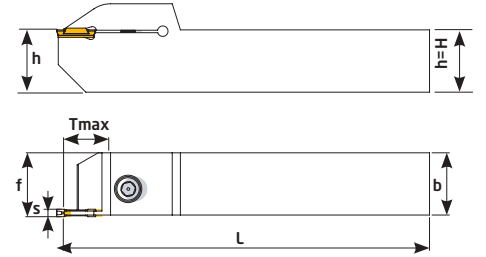

Sipariş Kodu Order Code Best.-Nr.	Stok/Stock/Lager	Ürün Kodu Product Code Produkt-Code	Ölçüler (mm) Dimensions(mm) Abmessungen (mm)								Kullanılan Uç Insert WSP	Sıkma Civatası Clamp Screw Inbuss-Schraube	Anahtar Allen Key Inbuss-Schlüssel
			h=H	b	S	Tmax	f	L					
D773	●	2020 3C-R GRP	20	20	3	18	20	125	0,409	3C GRP ISCR	TC132 M5x20	4 Allen	
D769	●	2525 3C-R GRP	25	25	3	18	25	150	0,755				
D770	●	2525 4C-R GRP	25	25	4	20	25	150	0,747	4C GRP ISCR	TC134 M6x20	5 Allen	
D772	○	3232 4C-R GRP	32	32	4	18	32	170	1,285				
D771	●	2525 5C-R GRP	25	25	5	24	25	150	0,739	5C GRP ISCR	TC134 M6x20	5 Allen	
D774	○	3232 5C-R GRP	32	32	5	24	32	170	1,264				

ISCR ucuna uygundur. / Compatible with ISCR insert. / Kompatible für ISCR WP

● Stokta/ In Stock/ Lager ○ Sınırlı Stok/ Limited Stock/ Begrenzte Lagerhaltung

ISCR /R

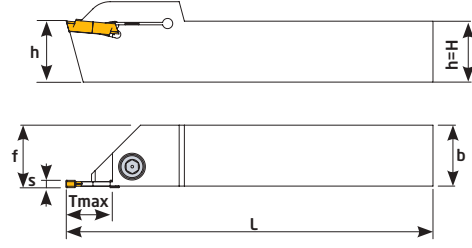

Sipariş Kodu Order Code Best.-Nr.	Stok/Stock/Lager	Ürün Kodu Product Code Produkt-Code	Ölçüler (mm) Dimensions(mm) Abmessungen (mm)								Kullanılan Uç Insert WSP	Sıkma Civatası Clamp Screw Inbuss-Schraube	Anahtar Allen Key Inbuss-Schlüssel
			h=H	b	S	Tmax	f	L	kg				
D750	●	1212 2C-R DGN	12	12	2	16	12	125	0,158	2C DGN ISCR	TC131 M5x16	4 Allen	
D752	●	1616 2C-R DGN	16	16	2	16	16	125	0,260				
D754	●	2020 2C-R DGN	20	20	2	18	20	125	0,398				
D756	●	2525 2C-R DGN	25	25	2	19	25	150	0,712				
D758	●	1212 3C-R DGN	12	12	3	16	12	125	0,160	3C DGN ISCR	TC131 M5x16	4 Allen	
D760	●	1616 3C-R DGN	16	16	3	19	16	125	0,253				
D762	●	2020 3C-R DGN	20	20	3	20	20	125	0,394				
D764	●	2525 3C-R DGN	25	25	3	22	25	150	0,711				
D775	●	2020 4C-R DGN	20	20	4	20	20	125	0,391	4C DGN ISCR	TC132 M5x20	4 Allen	
D777	●	2525 4C-R DGN	25	25	4	20	25	150	0,709				

ISCR /L

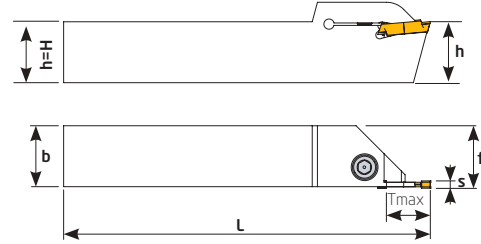

Sipariş Kodu Order Code Best.-Nr.	Stok/Stock/Lager	Ürün Kodu Product Code Produkt-Code	Ölçüler (mm) Dimensions(mm) Abmessungen (mm)								Kullanılan Uç Insert WSP	Sıkma Civatası Clamp Screw Inbuss-Schraube	Anahtar Allen Key Inbuss-Schlüssel
			h=H	b	S	Tmax	f	L	kg				
D726	●	1212 2C-L DGN	12	12	2	16	12	125	0,158	2C DGN ISCR	TC131 M5x16	4 Allen	
D727	●	1616 2C-L DGN	16	16	2	16	16	125	0,260				
D728	●	2020 2C-L DGN	20	20	2	18	20	125	0,398				
D729	●	2525 2C-L DGN	25	25	2	19	25	150	0,712				
D730	●	1212-3C-L DGN	12	12	3	16	12	125	0,160	3C DGN ISCR	TC131 M5x16	4 Allen	
D731	●	1616 3C-L DGN	16	16	3	19	16	125	0,253				
D732	●	2020 3C-L DGN	20	20	3	20	20	125	0,394				
D733	●	2525 3C-L DGN	25	25	3	22	25	150	0,711				

ISCR ucuna uygundur. / Compatible with ISCR insert. / Kompatibel für ISCR WP

● Stokta/In Stock/Lager ○ Sınırlı Stok/Limited Stock/Begrenzte Lagerhaltung

ZCC/R ZT-D

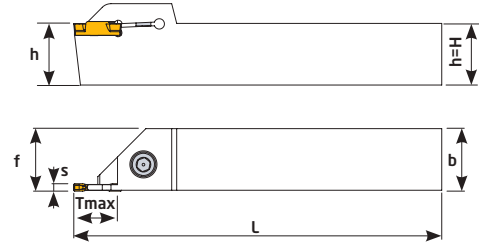

Sipariş Kodu Order Code Best.-Nr.	Stok/Stock/Lager	Ürün Kodu Product Code Produkt-Code	Ölçüler (mm) Dimensions(mm) Abmessungen (mm)							Kullanılan Uç Insert WSP	Sıkma Civatası Clamp Screw Inbuss-Schraube	Anahtar Allen Key Inbuss-Schlüssel
			h=H	b	S	Tmax	f	L	kg			
D027	●	1616 3C-R ZT-D	16	16	3	18	16	125	0,301	3C ZT.D ZCC	TC131 M5x16	4 Allen
D028	●	2020 3C-R ZT-D	20	20	3	18	20	125	0,394		TC132 M5x20	
D030	●	2525 3C-R ZT-D	25	25	3	22	25	150	0,755		TC134 M6x20	5 Allen
D036	●	2020 4C-R ZT-D	20	20	4	18	20	125	0,400	4C ZT.D ZCC	TC132 M5x20	4 Allen
D038	●	2525 4C-R ZT-D	25	25	4	22	25	150	0,747		TC134 M6x20	5 Allen
D044	●	2020 5C-R ZT-D	20	20	5	18	20	125	0,391	5C ZT.D ZCC	TC132 M5x20	4 Allen
D046	●	2525 5C-R ZT-D	25	25	5	18	25	150	0,734		TC134 M6x20	5 Allen
D049	●	2525 6C-R ZT-D	25	25	6	18	25	150	0,745	6C ZT.D ZCC	TC134 M6x20	5 Allen
D051	●	3232 6C-R ZT-D	32	32	6	20	32	170	1,331			

ZCC ucuna uygundur. / Compatible with ZCC insert. / Kompatible für ZCC WP

TKT /R TD

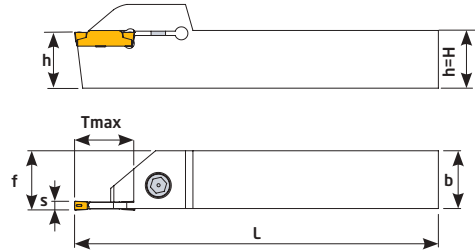

Sipariş Kodu Order Code Best.-Nr.	Stok/Stock/Lager	Ürün Kodu Product Code Produkt-Code	Ölçüler (mm) Dimensions(mm) Abmessungen (mm)							Kullanılan Uç Insert WSP	Sıkma Civatası Clamp Screw Inbuss-Schraube	Anahtar Allen Key Inbuss-Schlüssel
			h=H	b	S	Tmax	f	L	kg			
D714	●	1212 2C-R TD	12	12	2	16	12	125	0,166	2C TD TGTC	TC131 M5x16	4 Allen
D715	●	1616 2C-R TD	16	16	2	16	16	125	0,270		TC132 M5x20	
D716	●	2020 2C-R TD	20	20	2	16	20	125	0,401		TC134 M6x20	5 Allen
D717	●	2525 2C-R TD	25	25	2	18	25	150	0,728	3C TD TGTC	TC131 M5x16	4 Allen
D718	●	1212 3C-R TD	12	12	2	16	12	125	0,160		TC132 M5x20	
D719	●	1616 3C-R TD	16	16	3	18	16	125	0,256		TC134 M6x20	5 Allen
D720	●	2020 3C-R TD	20	20	3	18	20	125	0,398	4C TD TGTC	TC132 M5x20	4 Allen
D721	●	2525 3C-R TD	25	25	3	18	25	150	0,735		TC134 M6x20	
D722	●	2020 4C-R TD	20	20	4	18	20	125	0,401	4C TD TGTC	TC132 M5x20	4 Allen
D723	●	2525 4C-R TD	25	25	4	18	25	150	0,735		TC134 M6x20	

TGTC ucuna uygundur. / Compatible with TGTC insert. / Kompatible für TGTC WP

● Stokta/In Stock/Lager ○ Sınırlı Stok/Limited Stock/Begrenzte Lagerhaltung

K-HRN/R S224

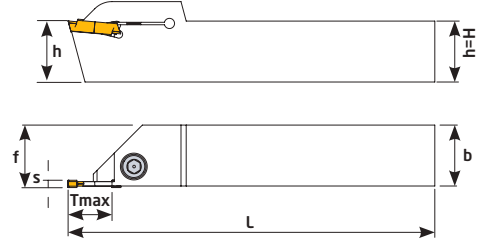

Sipariş Kodu Order Code Best.-Nr.	Stok/Stock/Lager	Ürün Kodu Product Code Produkt-Code	Ölçüler (mm) Dimensions(mm) Abmessungen (mm)							Kullanılan Uç Insert WSP	Sıkma Cıvatası Clamp Screw Inbuss-Schraube	Anahtar Allen Key Inbuss-Schlüssel
			h=H	b	S	Tmax	f	L	Ⓢ			
D700	●	1616 2C-R S224	16	16	2	18	16	125	0,258	TC131 M5x16	4 Allen	4 Allen
D701	●	2020 2C-R S224	20	20	2	18	20	125	0,406			
D702	●	2525 2C-R S224	25	25	2	18	25	150	0,713	TC132 M5x20	5 Allen	5 Allen
D703	●	1616 3C-R S224	16	16	3	18	16	100	0,260	TC134 M6x20		
D704	●	2020 3C-R S224	20	20	3	18	20	125	0,407	TC132 M5x20	4 Allen	4 Allen
D705	●	2525 3C-R S224	25	25	3	18	25	150	0,720			
D706	●	2020 4C-R S224	20	20	4	18	20	125	0,401	TC132 M5x20	5 Allen	5 Allen
D707	●	2525 4C-R S224	25	25	4	18	25	150	0,737	TC134 M6x20		
D708	●	2020 5C-R S224	20	20	5	18	20	125	0,401	TC132 M5x20	4 Allen	4 Allen
D710	●	2525 5C-R S224	25	25	5	18	25	150	0,730	TC134 M6x20	5 Allen	5 Allen

HRN ucuna uygundur. / Compatible with HRN insert. / Kompatible für HRN WP



B-HRN/R S229

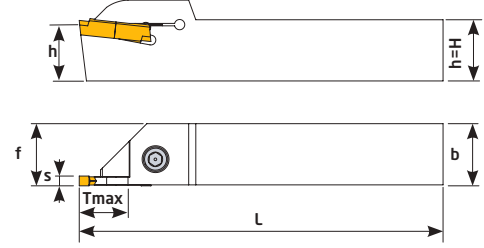

Sipariş Kodu Order Code Best.-Nr.	Stok/Stock/Lager	Ürün Kodu Product Code Produkt-Code	Ölçüler (mm) Dimensions(mm) Abmessungen (mm)							Kullanılan Uç Insert WSP	Sıkma Cıvatası Clamp Screw Inbuss-Schraube	Anahtar Allen Key Inbuss-Schlüssel
			h=H	b	S	Tmax	f	L	kg			
D688	●	2020 3C-R S229	20	20	3	22	20	125	0,391	3C S229 B-HRN	TC132 M5x20	4 Allen
D690	●	2525 3C-R S229	25	25	3	22	25	150	0,700		TC134 M6x20	5 Allen
D692	●	2020 4C-R S229	20	20	4	22	20	125	0,386	4C S229 B-HRN	TC132 M5x20	4 Allen
D694	●	2525 4C-R S229	25	25	4	22	25	150	0,705		TC134 M6x20	5 Allen
D696	●	2020 5C-R S229	20	20	5	22	20	125	0,389	5C S229 B-HRN	TC132 M5x20	4 Allen
D698	●	2525 5C-R S229	25	25	5	22	25	150	0,709		TC134 M6x20	5 Allen

B-HRN/L S229

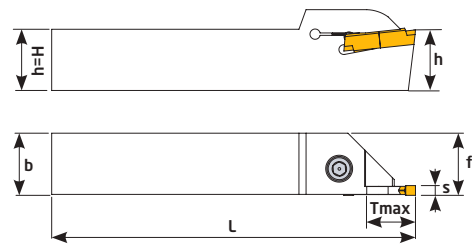

Sipariş Kodu Order Code Best.-Nr.	Stok/Stock/Lager	Ürün Kodu Product Code Produkt-Code	Ölçüler (mm) Dimensions(mm) Abmessungen (mm)							Kullanılan Uç Insert WSP	Sıkma Cıvatası Clamp Screw Inbuss-Schraube	Anahtar Allen Key Inbuss-Schlüssel
			h=H	b	S	Tmax	f	L	kg			
D711	●	2525 3C-L S229	25	25	3	22	25	150	0,700	3C S229 B-HRN	TC134 M6x20	5 Allen
D712	●	2525 4C-L S229	25	25	4	22	25	150	0,705	4C S229 B-HRN		
D713	●	2525 5C-L S229	25	25	5	22	25	150	0,709	5C S229 B-HRN		

HRN ucuna uygundur. / Compatible with HRN insert. / Kompatibel für HRN WP

SDV 123-R

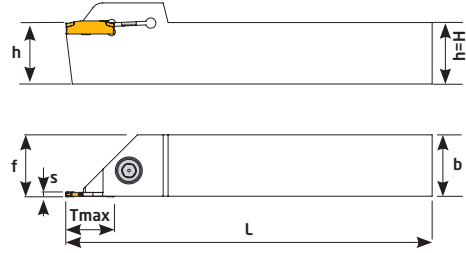

Sipariş Kodu Order Code Best.-Nr.	Stok/Stok/Lager	Ürün Kodu Product Code Produkt-Code	Ölçüler (mm) Dimensions(mm) Abmessungen (mm)							Kullanılan Uç Insert WSP	Sıkma Civatası Clamp Screw Inbuss-Schraube	Anahtar Allen Key Inbuss-Schlüssel
			h=H	b	S	Tmax	f	L				
D900	●	2020 2C-123 SDV-R	20	20	2	18	20	125	0,400	2C 123 SDV	TC132 M5x20	4 Allen
D902	●	2525 2C-123 SDV-R	25	25	2	18	25	150	0,732		TC134 M6x20	5 Allen
D904	●	2020 3C-123 SDV-R	20	20	3	19	20	125	0,397	3C 123 SDV	TC132 M5x20	4 Allen
D906	●	2525 3C-123 SDV-R	25	25	3	20	25	150	0,713		TC134 M6x20	5 Allen
D908	●	2020 4C-123 SDV-R	20	20	4	18	20	125	0,415	4C 123 SDV	TC132 M5x20	4 Allen
D910	●	2525 4C-123 SDV-R	25	25	4	18	25	150	0,724		TC134 M6x20	5 Allen
D912	●	2525 5C-123 SDV-R	25	25	5	18	25	150	0,725	5C 123 SDV		

SNDVK ucuna uygundur. / Compatible with SNDVK insert. / Kompatible für SNDVK WP

SDV 123-L

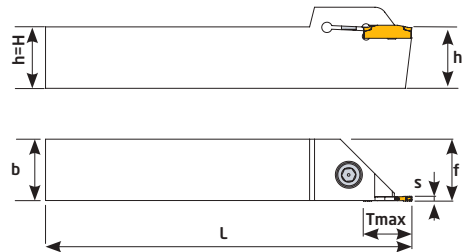

Sipariş Kodu Order Code Best.-Nr.	Stok/Stok/Lager	Ürün Kodu Product Code Produkt-Code	Ölçüler (mm) Dimensions(mm) Abmessungen (mm)							Kullanılan Uç Insert WSP	Sıkma Civatası Clamp Screw Inbuss-Schraube	Anahtar Allen Key Inbuss-Schlüssel
			h=H	b	S	Tmax	f	L				
D873	○	2020 2C-123 SDV-L	20	20	2	18	20	125	0,400	2C 123 SDV	TC132 M5x20	4 Allen
D874	○	2525 2C-123 SDV-L	25	25	2	18	25	150	0,732		TC134 M6x20	5 Allen
D875	○	2020 3C-123 SDV-L	20	20	3	19	20	125	0,397	3C 123 SDV	TC132 M5x20	4 Allen
D876	○	2525 3C-123 SDV-L	25	25	3	20	25	150	0,713		TC134 M6x20	5 Allen
D877	○	2020 4C-123 SDV-L	20	20	4	18	20	125	0,415	4C 123 SDV	TC132 M5x20	4 Allen
D878	○	2525 4C-123 SDV-L	25	25	4	18	25	150	0,724		TC134 M6x20	5 Allen
D879	○	2525 5C-123 SDV-L	25	25	5	18	25	150	0,725	5C 123 SDV		

SNDVK ucuna uygundur. / Compatible with SNDVK insert. / Kompatible für SNDVK WP

DGM 2-3

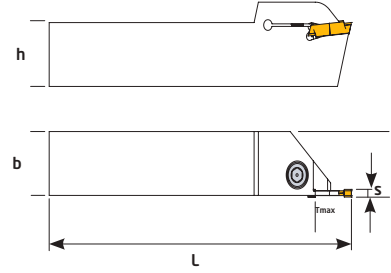

Sipariş Kodu Order Code Best.-Nr.	Stok/Stock/Lager	Ürün Kodu Product Code Produkt-Code	Ölçüler (mm) Dimensions(mm) Abmessungen (mm)							Kullanılan Uç Insert WSP	Sıkma Civatası Clamp Screw Inbuss-Schraube	Anahtar Allen Key Inbuss-Schlüssel
			h=H	b	S	Tmax	f	L				
D842	●	1212 2C-DGM 2	12	12	2	16	12	125	0,166	2C DGM 2 TNGLY	TC131 M5x16	4 Allen
D843	●	1616 2C-DGM 2	16	16	2	17	16	125	0,267			
D844	●	2020 2C-DGM 2	20	20	2	17	20	125	0,403			
D845	●	2525 2C-DGM 2	25	25	2	17	25	150	0,739	3C DGM 3 TNGLY	TC132 M5x20	5 Allen
D847	●	1212 3C-DGM 3	12	12	3	16	12	125	0,168			
D848	●	1616 3C-DGM 3	16	16	3	17	16	125	0,263			
D849	●	2020 3C-DGM 3	20	20	3	20	20	125	0,395	TC134 M6x20	5 Allen	
D850	●	2525 3C-DGM 3	25	25	3	20	25	150	0,740			

TNGLY ucuna uygundur. / Compatible with TNGLY insert. / Kompatibel für TNGLY WP

GX16-GX24

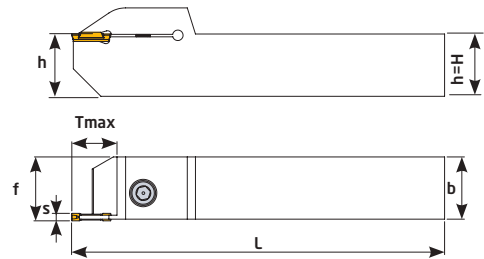

Sipariş Kodu Order Code Best.-Nr.	Stok/Stock/Lager	Ürün Kodu Product Code Produkt-Code	Ölçüler (mm) Dimensions(mm) Abmessungen (mm)							Kullanılan Uç Insert WSP	Sıkma Civatası Clamp Screw Inbuss-Schraube	Anahtar Allen Key Inbuss-Schlüssel
			h=H	b	S	Tmax	f	L				
D858	●	2020 2C GX16	20	20	2	18	20	125	0,267	GX16 WLTR	TC132 M5x20	4 Allen
D859	●	2525 2C GX16	25	25	2	18	25	150	0,403			
D860	●	2020 3C GX16	20	20	3	20	20	125	0,395			
D861	●	2525 3C GX16	25	25	3	22	25	150	0,740	GX24 WLTR	TC134 M6x20	5 Allen
D864	●	2020 2C GX24	20	20	2	18	20	125	0,403			
D865	●	2525 2C GX24	25	25	2	18	25	150	0,739			
D866	●	2020 3C GX24	20	20	3	20	20	125	0,395	TC132 M5x20	4 Allen	
D867	●	2525 3C GX24	25	25	3	22	25	150	0,740			

WLTR ucuna uygundur. / Compatible with WLTR insert. / Kompatibel für WLTR WP

● Stokta/In Stock/Lager ○ Sınırlı Stok/Limited Stock/Begrenzte Lagerhaltung

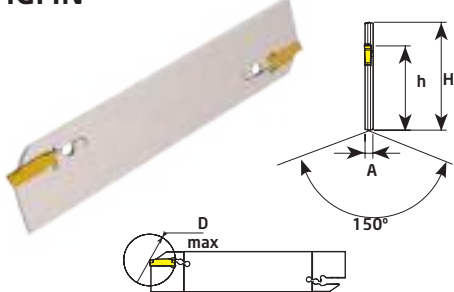
MGMN	Sipariş Kodu Order Code Best.-Nr.	Sipariş Kodu Order Code Best.-Nr.	Ölçüler (mm) Dimensions(mm) Abmessungen (mm)					Kullanılan Uç Insert WSP
			H	h	A	L	D max	
				KL30	32-3	32	25	
	KL32	32-4	32	25	3,45	150	36	MGMN 400

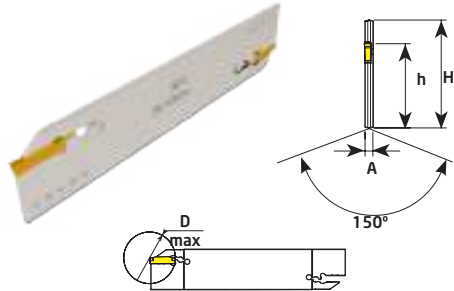
KGMN	Sipariş Kodu Order Code Best.-Nr.	Sipariş Kodu Order Code Best.-Nr.	Ölçüler (mm) Dimensions(mm) Abmessungen (mm)					Kullanılan Uç Insert WSP
			H	h	A	L	D max	
				KL37	26-2	26	21,4	
	KL38	26-3	26	21,4	2,45	110	36	KGMN 300
	KL39	26-4	26	21,4	3,45	110	36	KGMN 400
	KL34	32-2	32	25	1,65	150	36	KGMN 200
	KL35	32-3	32	25	2,45	150	36	KGMN 300
	KL36	32-4	32	25	3,45	150	36	KGMN 400

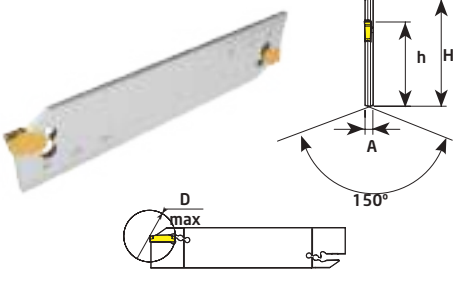
SP	Sipariş Kodu Order Code Best.-Nr.	Sipariş Kodu Order Code Best.-Nr.	Ölçüler (mm) Dimensions(mm) Abmessungen (mm)					Kullanılan Uç Insert WSP
			H	h	A	L	D max	
				KL40	26-3	26	21,4	
	KL42	26-4	26	21,4	3,45	110		SP 400
	KL44	32-3	32	25	2,45	150		SP 300
	KL45	32-4	32	25	3,45	150		SP 400

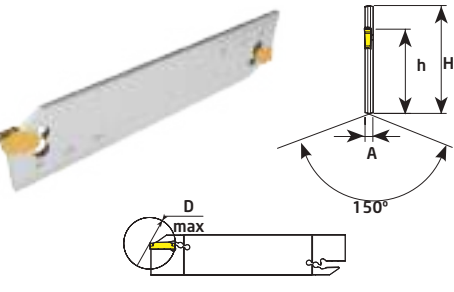
N151-3	Sipariş Kodu Order Code Best.-Nr.	Sipariş Kodu Order Code Best.-Nr.	Ölçüler (mm) Dimensions(mm) Abmessungen (mm)					Kullanılan Uç Insert WSP
			H	h	A	L	D max	
				KL52	26-3	26	21,4	
	KL54	26-4	26	21,4	3,45	110		N151-4
	KL56	32-3	32	25	2,45	150		N151-3
	KL58	32-4	32	25	3,45	150		N151-4

KESKİ KÜTÜĞÜ
Block for Blades

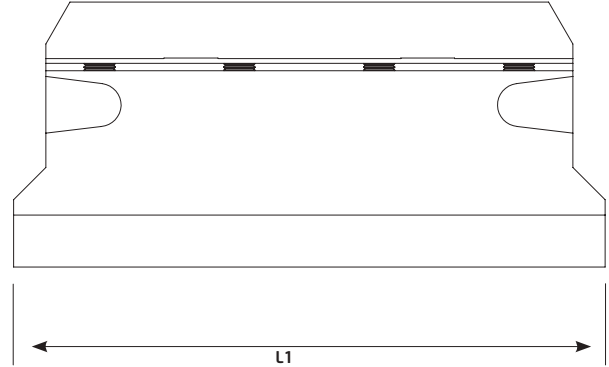
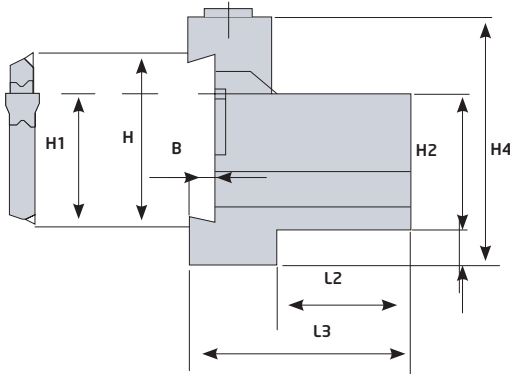

Sipariş Kodu Order Code Best.-Nr.	Stok/Stock/Lager	Ürün Kodu Product Code Produkt-Code	Ölçüler (mm) Dimensions(mm) Abmessungen (mm)						Papuç Clamp Spannpratze	Sıkma Civatası Clamp Screw Inbuss-Schraube	Anahtar Allen Key Inbuss-Schlüssel
			H	H1	H2	L1	L2	L3			
KLT 04	●	20-26	26	21,4	20	87	19	33			
KLT 05	●	25-26	26	24,4	25	110	20	34			
KLT 06	●	20-32	32	25	20	110	19	35			
KLT 08	●	25-32	32	25	25	110	20	36			
KLT 10	●	32-32	32	25	32	110	28	44			

İç Çap Kanal Kater
Grooving Holders
Stech-Klemmhalter

TEKNİK
Cutting Tools



www.teknikcuttingtools.com



Kalite için TEKNİK çözüm
Technical solution for quality



KRLY/R

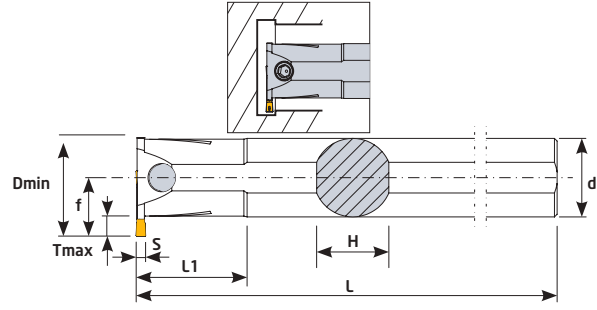

Sipariş Kodu Order Code Best.-Nr.	Stok/Stock/Lager	Ürün Kodu Product Code Produkt-Code	Ölçüler (mm) Dimensions(mm) Abmessungen (mm)									Kullanılan Uç Insert WSP	Sıkma Civatası Clamp Screw Inbuss-Schraube	Anahtar Allen Key Inbuss-Schlüssel
			Dmin	Tmax	L	L1	d	h	f	s	Ⓢ			
K600	●	S16Q 2C-R MGM	21	5	180	35	16	15	12,5	2	0,288	2C MGM KRLY	TC130 M5x12	4 Allen
K602	●	S20Q 2C-R MGM	26	5,7	180	35	20	18	15,5	2	0,440			
K603	●	S25R 2C-R MGM	31	5,7	200	35	25	23	18	2	0,787		TC131 M5x16	5 Allen
K604	●	S20Q 3C-R MGM	26	6	180	35	20	18	15,5	3	0,450	3C MGM KRLY		
K606	●	S25R 3C-R MGM	32	6,7	200	40	25	23	19	3	0,784			
K608	●	S32S 3C-R MGM	38	6,1	250	60	32	30	21,5	3	1,555		TC134 M6x20	5 Allen
K609	●	S40T 3C-R MGM	48	7,2	300	60	40	38	27	3	2,940			
K610	●	S20Q 4C-R MGM	26	6	180	35	20	18	15,5	4	0,443	4C MGM KRLY	TC130 M5x12	4 Allen
K612	●	S25R 4C-R MGM	31	6	200	40	25	23	18,2	4	0,783			
K614	●	S32S 4C-R MGM	38	6	250	60	32	30	21,5	4	1,552			
K616	●	S40T 4C-R MGM	47	7,2	300	60	40	38	27	4	2,942			
K618	●	S25R 5C-R MGM	32	7	200	40	25	23	19,2	5	0,777	5C MGM KRLY	TC131 M5x16	5 Allen
K620	●	S32S 5C-R MGM	39	7	250	60	32	30	22,5	5	1,561			
K622	●	S40T 5C-R MGM	47	7,4	300	60	40	38	27	5	2,936			

KGEVR-KGMN

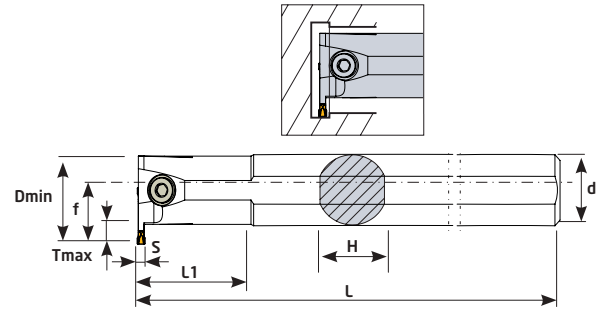

Sipariş Kodu Order Code Best.-Nr.	Stok/Stock/Lager	Ürün Kodu Product Code Produkt-Code	Ölçüler (mm) Dimensions(mm) Abmessungen (mm)									Kullanılan Uç Insert WSP	Sıkma Civatası Clamp Screw Inbuss-Schraube	Anahtar Allen Key Inbuss-Schlüssel
			Dmin	Tmax	L	L1	d	h	f	s	Ⓢ			
K660	●	S16K 2C KGMN	23	6,5	125	35	16	15	14	2	0,220	KGEVR-KGMN 200 KRLY	TC130 M5x12	4 Allen
K661	●	S20M 2C KGMN	25	6,5	150	45	20	18	15,5	2	0,374			
K662	●	S25R 2C KGMN	32	7	200	45	25	23	19	2	0,802		TC131 M5x16	
K663	●	S20M 3C KGMN	25	6,5	150	45	20	18	15,5	3	0,370	KGEVR-KGMN 300 KRLY		TC130 M5x12
K664	●	S25R 3C KGMN	32	7	200	45	25	23	19	3	0,800			
K665	●	S32S 3C KGMN	40	7,5	250	55	32	30	22,5	3	1,627		TC134 M6x20	
K666	●	S20M 4C KGMN	25	6,5	150	45	20	18	15,5	4	0,374	KGEVR-KGMN 400 KRLY		TC130 M5x12
K667	●	S25R 4C KGMN	32	7	200	45	25	23	19	4	0,796			
K668	●	S32S 4C KGMN	40	7,5	250	55	32	30	22,5	4	1,623		TC131 M5x16	
												TC134 M6x20		

KRLY ucuna uygundur. / Compatible with KRLY insert. / Kompatible für KRLY WP

● Stokta/ In Stock/ Lager ○ Sınırlı Stok/ Limited Stock/ Begrenzte Lagerhaltung

HRN/R S229

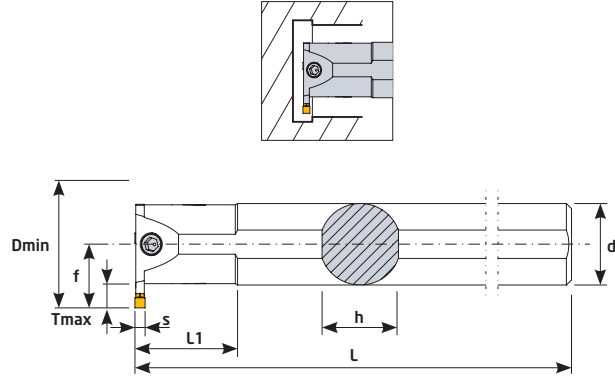

Sipariş Kodu Order Code Best.-Nr.	Stok/Stock/Lager	Ürün Kodu Product Code Produkt-Code	Ölçüler (mm) Dimensions(mm) Abmessungen (mm)									Kullanılan Uç Insert WSP	Sıkma Cıvatası Clamp Screw Inbuss-Schraube	Anahtar Allen Key Inbuss-Schlüssel
			Dmin	Tmax	L	L1	d	h	f	s	Ⓢ			
K624	●	S25R 3C-R S229	34	9,8	200	50	25	23	21,5	3	0,766	3C S229 B.HRN	TC131 M5x16	4 Allen
K626	●	S32S 3C-R S229	41	9	250	50	32	30	24,5	3	1,560		TC134 M6x20	5 Allen
K628	●	S40T 3C-R S229	49	9	300	50	40	38	28,5	3	2,594		TC131 M5x16	4 Allen
K630	●	S25R 4C-R S229	34	9,8	200	50	25	23	21,5	4	0,768	4C S229 B.HRN	TC131 M5x16	4 Allen
K632	●	S32S 4C-R S229	42	9	250	50	32	30	24,7	4	1,656		TC134 M6x20	5 Allen
K634	●	S40T 4C-R S229	49	9	300	50	40	38	28,5	4	3,113	5C S229 B.HRN	TC131 M5x16	4 Allen
K636	●	S25R 5C-R S229	33	9,5	200	50	25	23	21,1	5	0,770		TC131 M5x16	4 Allen
K638	●	S32S 5C-R S229	41	9	250	50	32	30	24,7	5	1,659		TC134 M6x20	5 Allen
K640	●	S40T 5C-R S229	49	9	300	50	40	38	28,5	5	3,109	TC134 M6x20	5 Allen	

HRN ucuna uygundur. / Compatible with HRN insert. / Kompatible für HRN WP

SDV/R 123

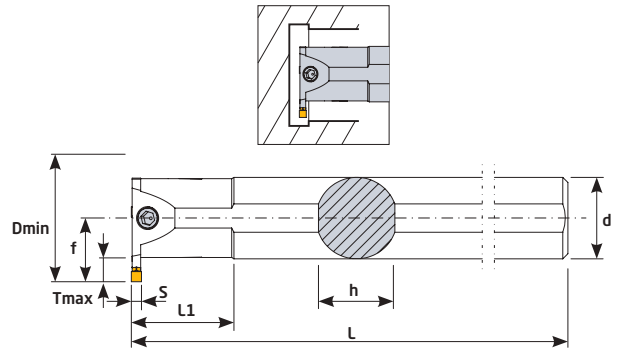

Sipariş Kodu Order Code Best.-Nr.	Stok/Stock/Lager	Ürün Kodu Product Code Produkt-Code	Ölçüler (mm) Dimensions(mm) Abmessungen (mm)									Kullanılan Uç Insert WSP	Sıkma Cıvatası Clamp Screw Inbuss-Schraube	Anahtar Allen Key Inbuss-Schlüssel
			Dmin	Tmax	L	L1	d	h	f	s	Ⓢ			
K720	●	S25R 3C-R-123 SDV	32	7	200	40	25	23	19,2	3	0,784	3C 123 SNDVK	TC131 M5x16	4 Allen
K722	●	S32S 3C-R-123 SDV	39	7	250	60	32	30	22,7	3	1,567		TC134 M6x20	5 Allen
K726	●	S25R 4C-R-123 SDV	32	7	200	40	25	23	19,5	4	0,772	4C 123 SNDVK	TC131 M5x16	4 Allen
K728	●	S32S 4C-R-123 SDV	39	7	250	60	32	30	22,5	4	2,854		TC134 M6x20	5 Allen
K730	●	S25S 5C-R-123 SDV	32	7	200	40	25	23	19,2	5	0,785	5C 123 SNDVK	TC131 M5x16	4 Allen
K732	●	S32S 5C-R-123 SDV	39	7	250	60	32	30	22,7	5	1,564		TC134 M6x20	5 Allen

SNDVK ucuna uygundur. / Compatible with SNDVK insert. / Kompatible für SNDVK WP

HRN/R S224

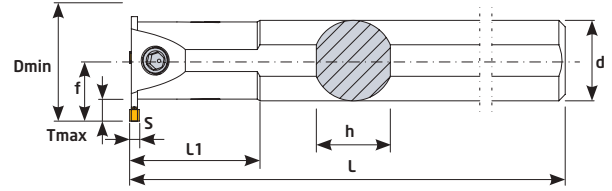
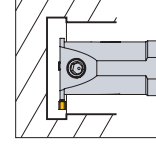

Sipariş Kodu Order Code Best.-Nr.	Stok/Stock/Lager	Ürün Kodu Product Code Produkt-Code	Ölçüler (mm) Dimensions(mm) Abmessungen (mm)									Kullanılan Uç Insert WSP	Sıkma Civatası Clamp Screw Inbuss-Schraube	Anahtar Allen Key Inbuss-Schlüssel
			Dmin	Tmax	L	L1	d	h	f	S	KG			
K642	●	S20Q 2C-R S224	26	6,5	180	40	20	18	16	2	0,444	2C S224 K.HRN	TC130 M5x12 TC131 M5x16	4 Allen
K644	●	S25R 2C-R S224	34	9	200	50	25	23	21,2	2	0,763			
K646	●	S20Q 3C-R S224	26	6,5	180	40	20	18	16	3	0,459	3C S224 K.HRN	TC130 M5x12 TC131 M5x16	5 Allen
K648	●	S25R 3C-R S224	33	9	200	50	25	23	20,6	3	0,782			
K650	●	S32S 3C-R S224	40	9	250	50	32	30	24,1	3	1,633	4C S224 K.HRN	TC130 M5x12 TC131 M5x16	4 Allen
K652	●	S20Q 4C-R S224	26	6,5	180	40	20	18	16	4	0,440			
K654	●	S25R 4C-R S224	33	9	200	50	25	23	20,6	4	0,764	TC134 M6x20	5 Allen	
K656	●	S32S 4C-R S224	42	9	250	50	32	30	23,5	4	1,672			

HRN ucuna uygundur. / Compatible with HRN insert. / Kompatibel für HRN WP

ZCC/R ZT.D

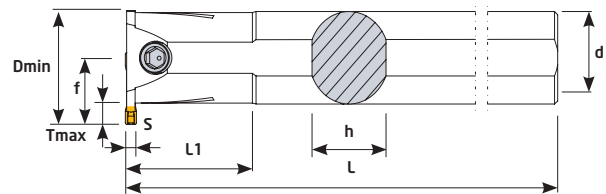
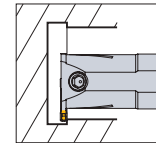

Sipariş Kodu Order Code Best.-Nr.	Stok/Stock/Lager	Ürün Kodu Product Code Produkt-Code	Ölçüler (mm) Dimensions(mm) Abmessungen (mm)									Kullanılan Uç Insert WSP	Sıkma Civatası Clamp Screw Inbuss-Schraube	Anahtar Allen Key Inbuss-Schlüssel
			Dmin	Tmax	L	L1	d	h	f	S	KG			
K679	●	S16Q 2C R ZT.D	20	4,9	180	35	16	15	12,5	2	0,446	2C ZT.D ZCC	TC130 M5x12	4 Allen
K680	●	S20Q 3C-R ZT.D	26	5,5	180	35	20	18	15,2	3	0,661	3C ZT.D ZCC		
K681	●	S25R 3C-R ZT.D	33	7,5	200	35	25	23	19,7	3	1,576		4C ZT.D ZCC	TC131 M5x16
K682	●	S32S 3C-R ZT.D	39	7	250	50	32	30	22,7	3	1,641	TC134 M6x20		4 Allen
K684	●	S25R 4C-R ZT.D	33	7,5	200	35	25	23	19,7	4	1,578		TC131 M5x16	
K685	●	S32S 4C-R ZT.D	39	7	250	50	32	30	22,7	4	1,645	TC134 M6x20		

ZCC ucuna uygundur. / Compatible with ZCC insert. / Kompatibel für ZCC ZCC WP

● Stokta/ In Stock/ Lager ○ Sınırlı Stok/ Limited Stock/ Begrenzte Lagerhaltung

GRP/R

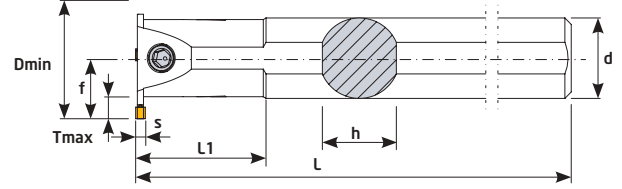
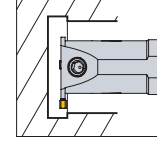

Sipariş Kodu Order Code Best.-Nr.	Stok/Stock/Lager	Ürün Kodu Product Code Produkt-Code	Ölçüler (mm) Dimensions(mm) Abmessungen (mm)										Kullanılan Uç Insert WSP	Sıkma Civatası Clamp Screw Inbuss-Schraube	Anahtar Allen Key Inbuss-Schlüssel
			Dmin	Tmax	L	L1	d	h	f	S	kg				
K700	●	S16Q 3C-R GRP	21	4,9	180	45	16	18	12,5	3	0,308	3C GRP ISCR	TC130 M5x12	4 Allen	
K702	●	S20Q 3C-R GRP	26	6	180	35	20	18	15,7	3	0,463				TC131 M5x16
K704	●	S25R 3C-R GRP	32	6,5	200	35	25	23	18,7	3	0,809		4C GRP ISCR	TC130 M5x12	4 Allen
K706	●	S20Q 4C-R GRP	26	5,5	180	35	20	18	15,2	4	0,463	TC131 M5x16			
K708	●	S25R 4C-R GRP	32	6,5	200	35	25	23	18,7	4	0,810	TC134 M6x20		5 Allen	
K710	●	S32S 4C-R GRP	38	6,5	250	60	32	30	22	4	1,655				

ISCR ucuna uygundur. / Compatible with ISCR insert. / Kompatible für ISCR WP

DGN/R

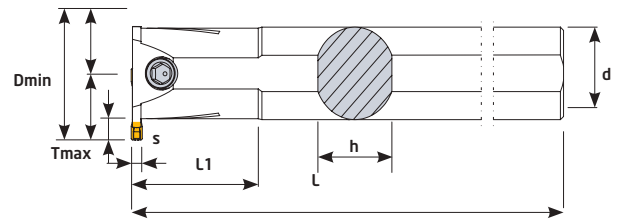
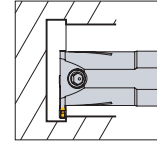

Sipariş Kodu Order Code Best.-Nr.	Stok/Stock/Lager	Ürün Kodu Product Code Produkt-Code	Ölçüler (mm) Dimensions(mm) Abmessungen (mm)										Kullanılan Uç Insert WSP	Sıkma Civatası Clamp Screw Inbuss-Schraube	Anahtar Allen Key Inbuss-Schlüssel
			Dmin	Tmax	L	L1	d	h	f	S	kg				
K672	●	S20Q 3C-R DGN	25	5,5	180	35	20	18	15	3	0,446	3C DGN ISCR	TC130 M5x12	4 Allen	
K673	●	S25R 3C-R DGN	31	6	200	40	25	23	18,2	3	0,798				TC131 M5x16
K674	●	S32S 3C-R DGN	37	6	250	55	32	30	30	3	1,620		TC134 M6x20	5 Allen	
K676	●	S20Q 4C-R DGN	25	5,5	180	35	20	18	18	4	0,461	4C DGN ISCR	TC130 M5x12	4 Allen	
K677	●	S25R 4C-R DGN	31	6	200	40	25	23	23	4	0,802				TC131 M5x16
K678	●	S32S 4C-R DGN	37	6	250	55	32	30	30	4	1,648		TC134 M6x20	5 Allen	

ISCR ucuna uygundur. / Compatible with ISCR insert. / Kompatible für ISCR WP

MINI KANAL KATERİ Mini Grooving Bars

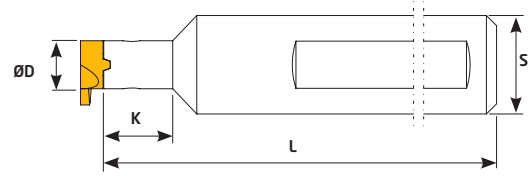

Sipariş Kodu Order Code Best.-Nr.	Stok/Stock/Lager	Ürün Kodu Product Code Produkt-Code	Ölçüler (mm) Dimensions(mm) Abmessungen (mm)					Kullanılan Uç Insert WSP	Sıkma Civatası Clamp Screw Torx-Schraube	Anahtar Torx Key Torx-Schlüssel
			S	D	K	L				
K801	●	S16 D5,9 K20 L120	16	5,9	20	120	0,143	NFTG 08 KRLY	TC069 M3,5x8,5	T10
K802	●	S16 D08 K25 L120	16	8	25	120	0,126	NFTG 11 KRLY	TC074 M4x10	T15
K803	●	S16 D09 K30 L120	16	9	30	120	0,120	NFTG 14 KRLY	TC060 M2,5x5,5	T8
K804	●	S16 D11 K30 L120	16	11	30	120	0,348	NFTG 16 KRLY	TC074 M4x10	T15

KRLY ucuna uygundur. / Compatible with KRLY insert. / Kompatibel für KRLY WP

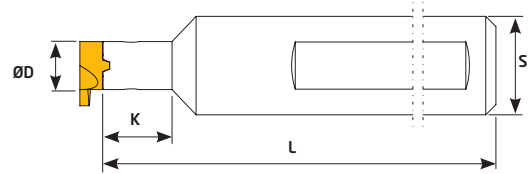

Sipariş Kodu Order Code Best.-Nr.	Stok/Stock/Lager	Ürün Kodu Product Code Produkt-Code	S	D	K	L		Kullanılan Uç Insert WSP	Sıkma Civatası Clamp Screw Torx-Schraube	Anahtar Torx Key Torx-Schlüssel
K812	●	S16 D09 K20 L93	16	9	20	93	0,102	D09	TC074 M4x10	T15
K814	●	S16 D06 K11 L78	16	6	11	78	0,082	D06	TC060 M2,5x5,5	T8
K816	●	S20 D14 K49 L160	20	14	49	160	0,367	D14	TC085 M5x12	T20

HRN ucuna uygundur. / Compatible with HRN insert. / Kompatibel für HRN WP

DIŞ AÇMA FREZELER Thread Cutting Cutter

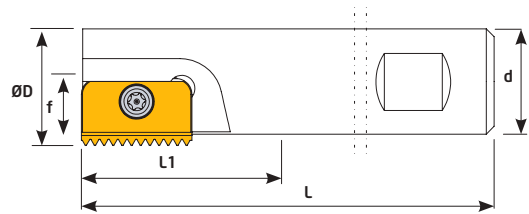

Sipariş Kodu Order Code Best.-Nr.	Stok/Stock/Lager	Ürün Kodu Product Code Produkt-Code	Ölçüler (mm) Dimensions(mm) Abmessungen (mm)						Kullanılan Uç Insert WSP	Sıkma Civatası Clamp Screw Torx-Schraube	Anahtar Torx Key Torx-Schlüssel	
			D	Z	L	L1	d	f				
DAF02	●	D12 Z01 L100 C14	12	1	100	40	12	6	0,085	C 14 CPT	TC065 M3x7	T8
DAF04	●	D12 Z01 L080 C14	12	1	80	30	20	6	0,143			
DAF06	●	D15 Z01 L100 C14	15	1	100	-	12	7,5	0,106			
DAF10	●	D21 Z01 L100 C21	21	1	100	50	20	10,5	0,210			
DAF12	●	D18 Z01 L120 C21	18	1	120	50	20	9	0,238	C 21 CPT	TC075 M4x11	T15
DAF14	●	D29 Z01 L120 C21	29	1	120	50	32	14,5	0,565			
DAF16	●	D36 Z02 L120 C21	36	2	120	50	32	18	0,697			
DAF18	●	D25 Z01 L150 C21	25	1	150	40	20	12,5	0,370			

CPT ucuna uygundur. / Compatible with CPT insert. / Kompatibel für CPT WP

● Stokta/In Stock/Lager ○ Sınırlı Stok/Limited Stock/Begrenzte Lagerhaltung