

93° PDJNR

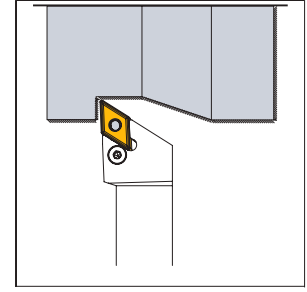

Sipariş Kodu Order Code Best.-Nr.	Stok/Stock/Lager	Ürün Kodu Product Code Produkt-Code	Ölçüler (mm) Dimensions(mm) Abmessungen (mm)						Kullanılan Uç Insert WSP	Sıkma Civatası Clamp Screw Klemm-Schraube	Altlık Shim U-Platte	Levye Sacı Lock Pin Rohrstift	Levye Lever Kniehebel	Anahtar Allen Key Inbuss-Schlüssel
			L	L1	h	f	b	Ⓜ						
P107	●	PDJNR 1616 H11	100	25	16	25	16	0,242	DNMG 1104	TH-613-4A M6	TA013	TS-3	TL3	2,5 Allen
P108	●	PDJNR 2020 K11	125	30	20	25	20	0,435		TH-617 M6				
P109	●	PDJNR 2525 M11	150	30	25	32	25	0,767						
P110	●	PDJNR 2020 K15	125	35	20	25	20	0,402	DNMG 1506	TH-822 M8	TA014-1	TS-4	TL4B	3 Allen
P112	●	PDJNR 2525 M15	150	38	25	32	25	0,730		TH-825 M8				
P114	●	PDJNR 3232 P15	170	38	32	40	32	1,384						

93° PDJNL

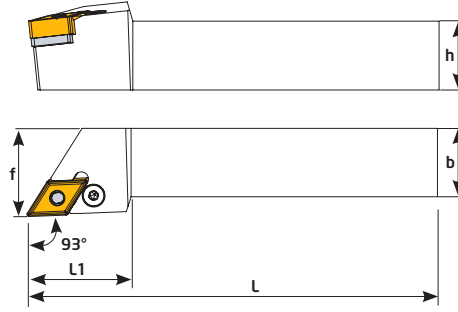
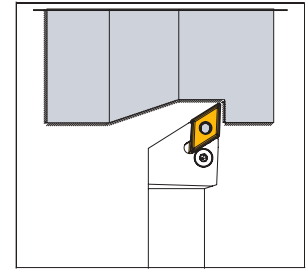
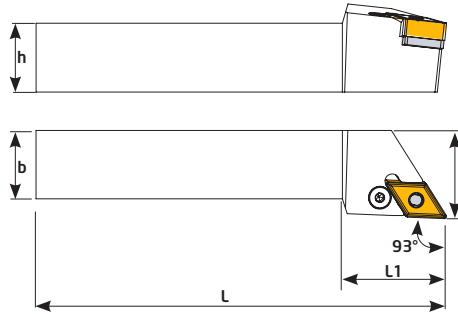

Sipariş Kodu Order Code Best.-Nr.	Stok/Stock/Lager	Ürün Kodu Product Code Produkt-Code	Ölçüler (mm) Dimensions(mm) Abmessungen (mm)						Kullanılan Uç Insert WSP	Sıkma Civatası Clamp Screw Klemm-Schraube	Altlık Shim U-Platte	Levye Sacı Lock Pin Rohrstift	Levye Lever Kniehebel	Anahtar Allen Key Inbuss-Schlüssel
			L	L1	h	f	b	Ⓜ						
P119	●	PDJNL 1616 H11	100	25	16	25	16	0,242	DNMG 1104	TH-613-4A M6	TA013	TS-3	TL3	2,5 Allen
P120	●	PDJNL 2020 K11	125	30	20	25	20	0,435		TH-617 M6				
P121	●	PDJNL 2525 M11	150	30	25	32	25	0,767						
P122	●	PDJNL 2020 K15	125	35	20	25	20	0,402	DNMG 1506	TH-822 M8	TA014-1	TS-4	TL4B	3 Allen
P124	●	PDJNL 2525 M15	150	38	25	32	25	0,730		TH-825 M8				
P126	●	PDJNL 3232 P15	170	38	32	40	32	1,384						

95° PCLNR

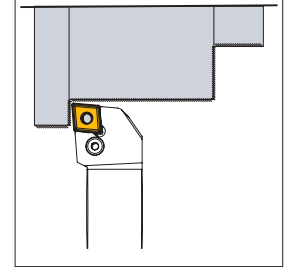
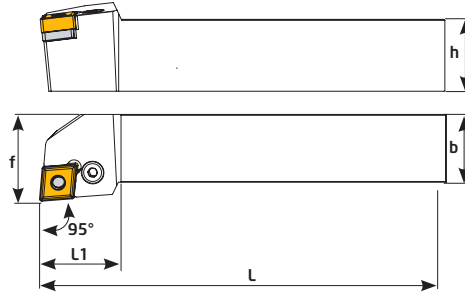

Sipariş Kodu Order Code Best.-Nr.	Stok/Stock/Lager	Ürün Kodu Product Code Produkt-Code	Ölçüler (mm) Dimensions(mm) Abmessungen (mm)							Kullanılan Uç Insert WSP	Sıkma Cıvatası Clamp Screw Klemm-Schraube	Altlık Shim U-Platte	Levye Sacı Lock Pin Rohrstift	Levye Lever Kniehebel	Anahtar Allen Key Inbuss-Schlüssel
			L	L1	h	f	b	kg							
P126-1	●	PCLNR 1616 H09	100	20	16	20	16	0,231	CNMG09T3	TH617 M6		TS3	TL3	2,5 Allen	
P127	●	PCLNR 2020 K09	125	22	20	25	20	0,428							
P128	●	PCLNR 2525 M09	150	22	25	32	25	0,785	CNMG1204	TH818 M8 TH821 M8	TA016-1	TS4	TL4	3 Allen	
P129	●	PCLNR 1616 H12	100	30	16	20	16	0,225							
P130	●	PCLNR 2020 K12	125	30	20	25	20	0,421							
P132	●	PCLNR 2525 M12	150	30	25	32	25	0,766							
P134	●	PCLNR 3232 P12	170	30	32	40	32	1,429							

95° PCLNL

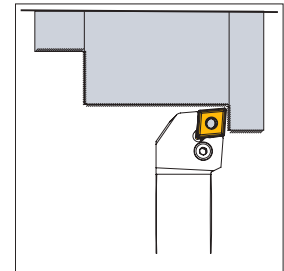
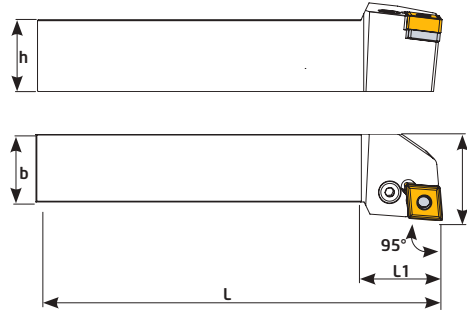

Sipariş Kodu Order Code Best.-Nr.	Stok/Stock/Lager	Ürün Kodu Product Code Produkt-Code	Ölçüler (mm) Dimensions(mm) Abmessungen (mm)							Kullanılan Uç Insert WSP	Sıkma Cıvatası Clamp Screw Klemm-Schraube	Altlık Shim U-Platte	Levye Sacı Lock Pin Rohrstift	Levye Lever Kniehebel	Anahtar Allen Key Inbuss-Schlüssel
			L	L1	h	f	b	kg							
P136	●	PCLNL 1616 H09	100	20	16	20	16	0,231	CNMG09T3	TH617 M6	TA015	TS3	TL3	2,5 Allen	
P137	●	PCLNL 2020 K09	125	22	20	25	20	0,428							
P138	●	PCLNL 2525 M09	150	22	25	32	25	0,785	CNMG1204	TH818 M8 TH821 M8	TA016-1	TS4	TL4	3 Allen	
P139	●	PCLNL 1616 H12	100	30	16	20	16	0,225							
P140	●	PCLNL 2020 K12	125	30	20	25	20	0,421							
P142	●	PCLNL 2525 M12	150	30	25	32	25	0,766							
P144	●	PCLNL 3232 P12	170	30	32	40	32	1,429							

95° PWLNR 08

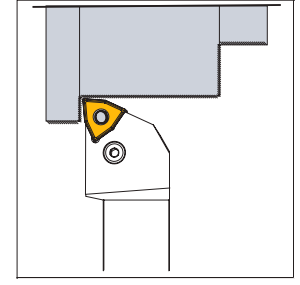
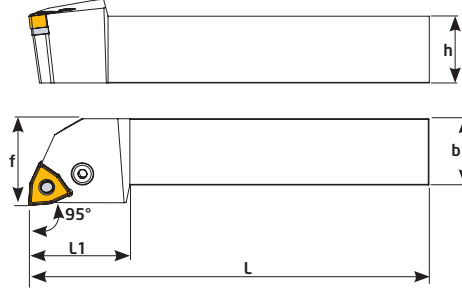

Sipariş Kodu Order Code Best.-Nr.	Stok/Stock/Lager	Ürün Kodu Product Code Produkt-Code	Ölçüler (mm) Dimensions(mm) Abmessungen (mm)						Kullanılan Uç Insert WSP	Sıkma Civatası Clamp Screw Klemm-Schraube	Altık Shim U-Platte	Levye Sacı Lock Pin Rohrstift	Levye Lever Kniehebel	Anahtar Allen Key Inbuss-Schlüssel
			L	L1	h	f	b	WSP						
P150	●	PWLNR 2020 K08	125	30	20	25	20	0,430	WNMG 0804	TH-821 M8	TA020-1	TS4	TL4	3 Allen
P151	●	PWLNR 2525 M08	150	38	25	32	25	0,773						
P152	●	PWLNR 3232 P08	170	38	32	40	32	1,421						

95° PWLNL 08

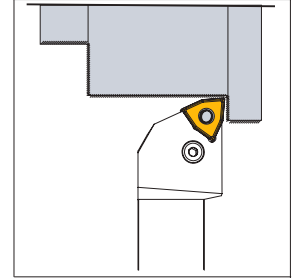
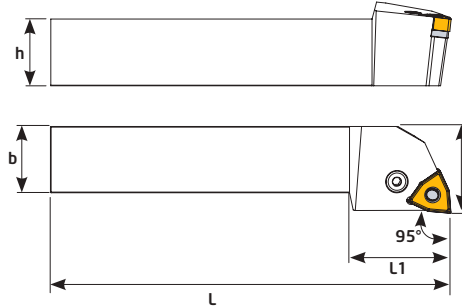

Sipariş Kodu Order Code Best.-Nr.	Stok/Stock/Lager	Ürün Kodu Product Code Produkt-Code	Ölçüler (mm) Dimensions(mm) Abmessungen (mm)						Kullanılan Uç Insert WSP	Sıkma Civatası Clamp Screw Klemm-Schraube	Altık Shim U-Platte	Levye Sacı Lock Pin Rohrstift	Levye Lever Kniehebel	Anahtar Allen Key Inbuss-Schlüssel
			L	L1	h	f	b	WSP						
P155	●	PWLNL 2020 K08	125	30	20	25	20	0,430	WNMG 0804	TH-821 M8	TA020-1	TS4	TL4	3 Allen
P156	●	PWLNL 2525 M08	150	38	25	32	25	0,773						
P157	●	PWLNL 3232 P08	170	38	32	40	32	1,421						

95° PWLNR 06

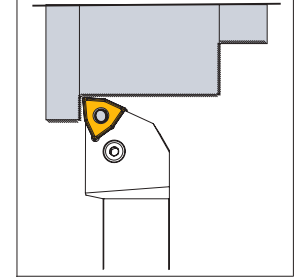
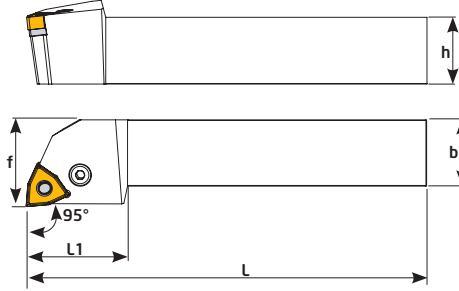

Sipariş Kodu Order Code Best.-Nr.	Stok/Stock/Lager	Ürün Kodu Product Code Produkt-Code	Ölçüler (mm) Dimensions(mm) Abmessungen (mm)						Kullanılan Uç Insert WSP	Sıkma Civatası Clamp Screw Klemm-Schraube	Altık Shim U-Platte	Levyé Sacı Lock Pin Rohrstift	Levyé Lever Kniehebel	Anahtar Allen Key Inbuss-Schlüssel
			L	L1	h	f	b	kg						
P158	●	PWLNR 1616 H06	100	30	16	20	16	0,223	WWMG 0604	TH-617 M6	TA021	TS3	TL3	2,5 Allen
P160	●	PWLNR 2020 K06	125	30	20	25	20	0,429						
P161	●	PWLNR 2525 M06	150	30	25	32	25	0,758						

95° PWLNL 06

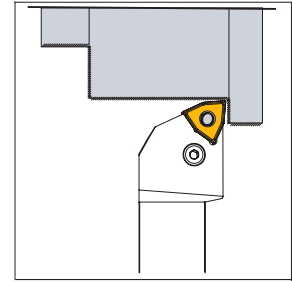
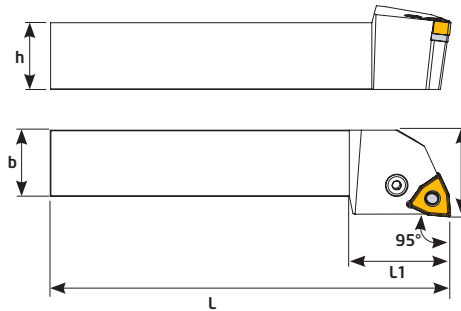

Sipariş Kodu Order Code Best.-Nr.	Stok/Stock/Lager	Ürün Kodu Product Code Produkt-Code	Ölçüler (mm) Dimensions(mm) Abmessungen (mm)						Kullanılan Uç Insert WSP	Sıkma Civatası Clamp Screw Klemm-Schraube	Altık Shim U-Platte	Altık Pimi Lock Pin Rohrstift	Levyé Lever Kniehebel	Anahtar Allen Key Inbuss-Schlüssel
			L	L1	h	f	b	kg						
P164	●	PWLNL 1616 H06	100	30	16	20	16	0,223	WWMG 0604	TH-617 M6	TA021	TS3	TL3	2,5 Allen
P165	●	PWLNL 2020 K06	125	30	20	25	20	0,429						
P166	●	PWLNL 2525 M06	150	30	25	32	25	0,758						

45° PSSNR

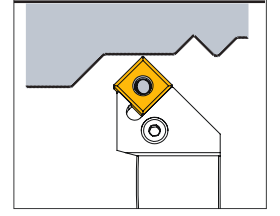
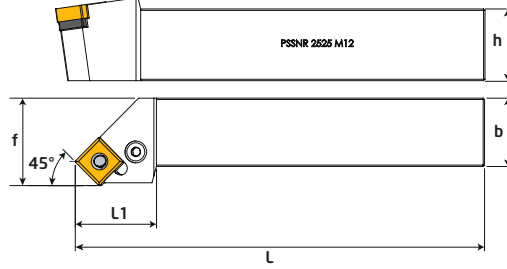

Sipariş Kodu Order Code Best.-Nr.	Stok/Lager	Ürün Kodu Product Code Produkt-Code	Ölçüler (mm) Dimensions(mm) Abmessungen (mm)						Kullanılan Uç Insert WSP	Sıkma Civatası Clamp Screw Klemm-Schraube	Altlık Shim U-Platte	Altlık Pimi Lock Pin Rohrstift	Levye Lever Kniehebel	Anahtar Allen Key Inbuss-Schlüssel
			L	L1	h	f	b	kg						
P170	●	PSSNR 1616 H12	100	30	16	20	16	0,218	SNMG1204	TH-818 M8	TA050	TS4	TL4	3 Allen
P171	●	PSSNR 2020 K12	125	30	20	25	20	0,416		TH-821 M8				
P172	●	PSSNR 2525 M12	150	30	25	32	25	0,742						

45° PSSNL

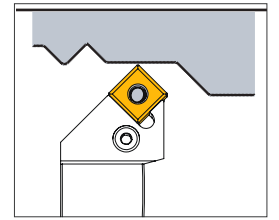
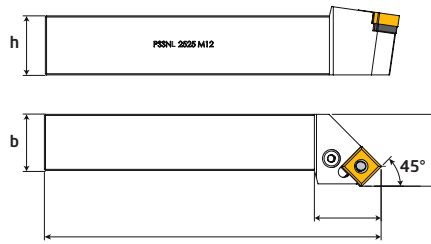

Sipariş Kodu Order Code Best.-Nr.	Stok/Lager	Ürün Kodu Product Code Produkt-Code	Ölçüler (mm) Dimensions(mm) Abmessungen (mm)						Kullanılan Uç Insert WSP	Sıkma Civatası Clamp Screw Klemm-Schraube	Altlık Shim U-Platte	Altlık Pimi Lock Pin Rohrstift	Levye Lever Kniehebel	Anahtar Allen Key Inbuss-Schlüssel
			L	L1	h	f	b	kg						
P180	●	PSSNL 1616 H12	100	30	16	20	16	0,218	SNMG1204	TH-818 M8	TA050	TS4	TL4	3 Allen
P181	●	PSSNL 2020 K12	125	30	20	25	20	0,416		TH-821 M8				
P182	●	PSSNL 2525 M12	150	30	25	32	25	0,742						

93° DDJNR

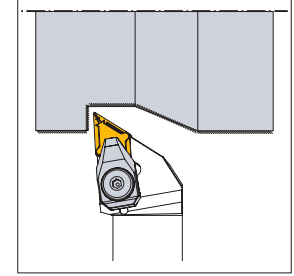
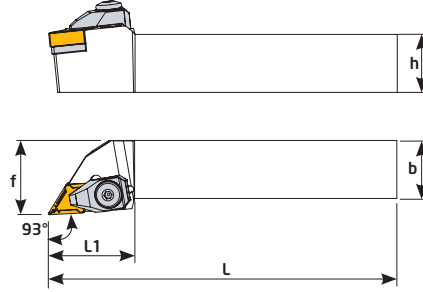

Sipariş Kodu Order Code Best.-Nr.	Stok/Stock/Lager	Ürün Kodu Product Code Produkt-Code	Ölçüler (mm) Dimensions(mm) Abmessungen (mm)						Kullanılan Uç Insert WSP	Baskı Cıvatası Locking Screw Verriegelungs Schraube	Altlık Shim U-Platte	Altlık Cıvatası Shim Screw U-Platte Schraube	Baskı Kepi Clamp Spann pratze	Yay Spring Feder	Pul Washer U-Scheibe	Anahtar Allen Key Inbuss-Schlüs- sel
			L	L1	h	f	b	kg								
D167	●	DDJNR 2020 K11	125	30	20	25	20	0,421	DN-- 1104	TC046 M5	TA030	TC075 M4x11	BK024	BY041	BSP031	3 Allen
D168	●	DDJNR 2525 M11	150	30	25	32	25	0,751								
D170	●	DDJNR 2020 K15	125	35	20	25	20	0,425								
D172	●	DDJNR 2525 M15	150	35	25	32	25	0,756	DN-- 1506	TC044 M6	TA014-1	TC038 M4x10	BK020	BY040	BSP030	4 Allen
D174	●	DDJNR 3232 P15	170	35	32	40	32	1,345								

93° DDJNL

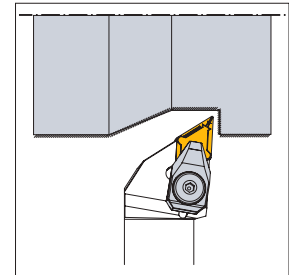
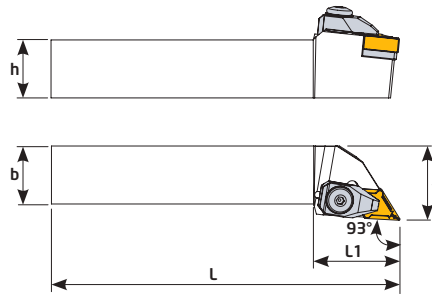

Sipariş Kodu Order Code Best.-Nr.	Stok/Stock/Lager	Ürün Kodu Product Code Produkt-Code	Ölçüler (mm) Dimensions(mm) Abmessungen (mm)						Kullanılan Uç Insert WSP	Baskı Cıvatası Locking Screw Verriegelungs Schraube	Altlık Shim U-Platte	Altlık Cıvatası Shim Screw U-Platte Schraube	Baskı Kepi Clamp Spann pratze	Yay Spring Feder	Pul Washer U-Scheibe	Anahtar Allen Key Inbuss-Schlüs- sel
			L	L1	h	f	b	kg								
D307-1	●	DDJNL 2020 K11	125	30	20	25	20	0,421	DN-- 1104	TC046 M5	TA030	TC075 M4x11	BK024	BY041	BSP031	3 Allen
D308	●	DDJNL 2525 M11	150	30	25	32	25	0,751								
D310	●	DDJNL 2020 K15	125	35	20	25	20	0,425								
D312	●	DDJNL 2525 M15	150	35	25	32	25	0,756	DN-- 1506	TC044 M6	TA014-1	TC038 M4x10	BK020	BY040	BSP030	4 Allen
D314	●	DDJNL 3232 P15	170	35	32	40	32	1,345								

62,5° DDNNN

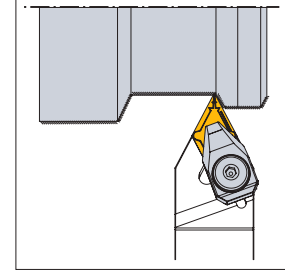
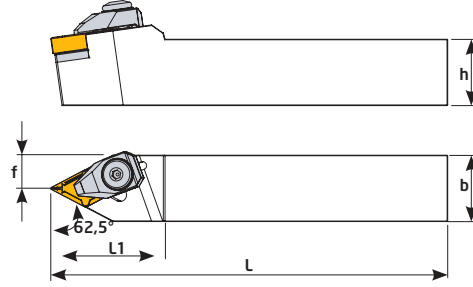

Sipariş Kodu Order Code Best.-Nr.	Stok/Stock/Lager	Ürün Kodu Product Code Produkt-Code	Ölçüler (mm) Dimensions(mm) Abmessungen (mm)						Kullanılan Uç Insert WSP	Baskı Civatası Locking Screw Verriegelungs Schraube	Altlık Shim U-Platte	Altlık Civatası Shim Screw U-Platte Schraube	Baskı Kepsini Clamp Spannpratze	Yay Spring Feder	Pul Washer U-Scheibe	Anahtar Allen Key Inbuss-Schlüssel
			L	L1	h	f	b	kg								
D104	●	DDNNN 2020 K15	125	40	20	10	20	0,404								
D106	●	DDNNN 2525 M15	150	40	25	12,5	25	0,724	DN-- 1506	TC044 M6	TA014-1	TC038 M4x10	BK020	BY040	BSP030	4 Allen
D109	●	DDNNN 3232 P15	170	40	32	16	32	1,290								



107,5° DDHNR

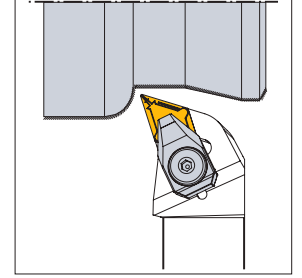
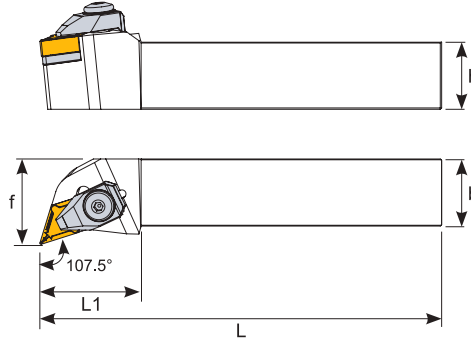

Sipariş Kodu Order Code Best.-Nr.	Stok/Stock/Lager	Ürün Kodu Product Code Produkt-Code	Ölçüler (mm) Dimensions(mm) Abmessungen (mm)							Kullanılan Uç Insert WSP	Baskı Civatası Locking Screw Verriegelungs Schraube	Altlık Shim U-Platte	Altlık Civatası Shim Screw U-Platte Schraube	Baskı Kepi Clamp Spann pratze	Yay Spring Feder	Pul Washer U-Scheibe	Anahtar Allen Key Inbuss-Schlüssel
			L	L1	h	f	b										
D096	●	DDHNR 2020 K15	125	33	20	25	20	0,428									
D097	●	DDHNR 2525 M15	150	33	25	32	25	0,753									
D098	●	DDHNR 3232 P15	170	33	32	40	32	1,290									

107,5° DDHNL

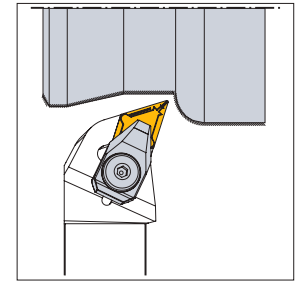
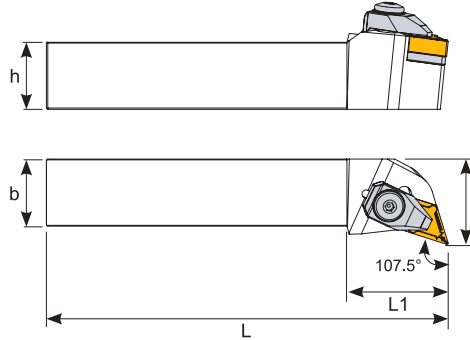

Sipariş Kodu Order Code Best.-Nr.	Stok/Stock/Lager	Ürün Kodu Product Code Produkt-Code	Ölçüler (mm) Dimensions(mm) Abmessungen (mm)							Kullanılan Uç Insert WSP	Baskı Civatası Locking Screw Verriegelungs Schraube	Altlık Shim U-Platte	Altlık Civatası Shim Screw U-Platte Schraube	Baskı Kepi Clamp Spann pratze	Yay Spring Feder	Pul Washer U-Scheibe	Anahtar Allen Key Inbuss-Schlüssel
			L	L1	h	f	b										
D295	●	DDHNL 2020 K15	125	33	20	25	20	0,428									
D296	●	DDHNL 2525 M15	150	33	25	32	25	0,753									
D297	●	DDHNL 3232 P15	170	33	32	40	32	1,290									

93° DDJNR

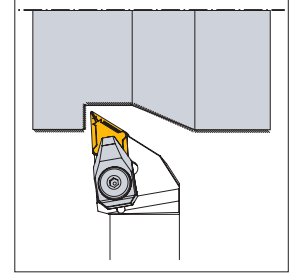
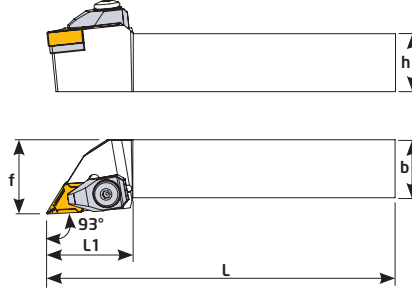

Sipariş Kodu Order Code Best.-Nr.	Stok/Stock/Lager	Ürün Kodu Product Code Produkt-Code	Ölçüler (mm) Dimensions(mm) Abmessungen (mm)							Kullanılan Uç Insert WSP	Baskı Civatası Locking Screw Verriegelungs Schraube	Altlık Shim U-Platte	Altlık Civatası Shim Screw U-Platte Schraube	Baskı Kepi Clamp Spannpratze	Yay Spring Feder	Pul Washer U-Scheibe	Anahtar Allen Key Inbuss-Schlüssel
			L	L1	h	f	b	kg									
D171	●	DDJNR 2020 K15	125	38	20	25	20	0,426	DN-- 1504	TC044 M6	TA014-1	TC038 M4x10	BK020	BY040	BSP030	4 Allen	
D169	●	DDJNR 2525 M15	150	38	25	32	25	0,763									

93° DDJNL

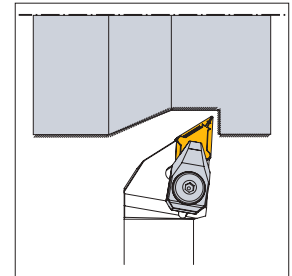
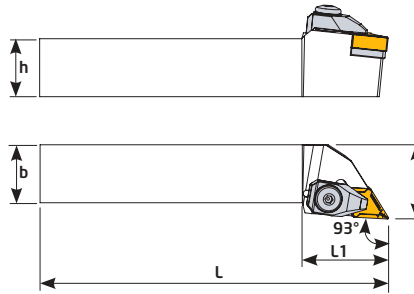

Sipariş Kodu Order Code Best.-Nr.	Stok/Stock/Lager	Ürün Kodu Product Code Produkt-Code	Ölçüler (mm) Dimensions(mm) Abmessungen (mm)							Kullanılan Uç Insert WSP	Baskı Civatası Locking Screw Verriegelungs Schraube	Altlık Shim U-Platte	Altlık Civatası Shim Screw U-Platte Schraube	Baskı Kepi Clamp Spannpratze	Yay Spring Feder	Pul Washer U-Scheibe	Anahtar Allen Key Inbuss-Schlüssel
			L	L1	h	f	b	kg									
D313	●	DDJNL 2020 K15	125	38	20	25	20	0,426	DN-- 1504	TC044 M6	TA014-1	TC038 M4x10	BK020	BY040	BSP030	4 Allen	
D309	●	DDJNL 2525 M15	150	38	25	32	25	0,763									

95° DWLNR

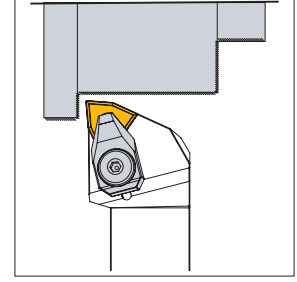
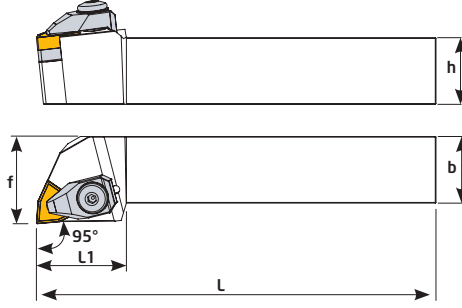

Sipariş Kodu Order Code Best.-Nr.	Stok/Stok/Lager	Ürün Kodu Product Code Produkt-Code	Ölçüler (mm) Dimensions(mm) Abmessungen (mm)						Kullanılan Uç Insert WSP	Baskı Cıvatası Locking Screw Verriegelungs Schraube	Altlık Shim U-Platte	Altlık Cıvatası Shim Screw U-Platte Schraube	Baskı Kepi Clamp Spannpratze	Yay Spring Feder	Pul Washer U-Scheibe	Anahtar Allen Key Inbuss-Schlüssel
			L	L1	h	f	b	kg								
D181	●	DWLNR 1616 H06	100	26	16	20	16	0,229	WN-- 0604	TC046 M5	TA021	TC034 M3x7	BK024	BY041	BSP031	3 Allen
D177	●	DWLNR 2020 K06	125	26	20	25	20	0,436								
D179	●	DWLNR 2525 M06	150	26	25	32	25	0,772								
D176	●	DWLNR 2020 K08	125	32	20	25	20	0,442	WN-- 0804	TC044 M6	TA020-1	TC083 M5x12	BK020	BY040	BSP030	4 Allen
D178	●	DWLNR 2525 M08	150	32	25	32	25	0,793								
D180	●	DWLNR 3232 P08	170	32	32	40	32	1,377								

95° DWLNL

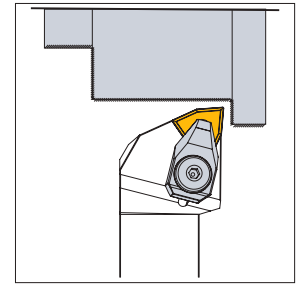
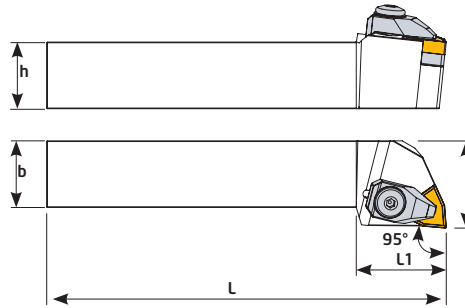

Sipariş Kodu Order Code Best.-Nr.	Stok/Stok/Lager	Ürün Kodu Product Code Produkt-Code	Ölçüler (mm) Dimensions(mm) Abmessungen (mm)						Kullanılan Uç Insert WSP	Baskı Cıvatası Locking Screw Verriegelungs Schraube	Altlık Shim U-Platte	Altlık Cıvatası Shim Screw U-Platte Schraube	Baskı Kepi Clamp Spannpratze	Yay Spring Feder	Pul Washer U-Scheibe	Anahtar Allen Key Inbuss-Schlüssel
			L	L1	h	f	b	kg								
D328	●	DWLNL 1616 H06	100	26	16	20	16	0,229	WN-- 0604	TC046 M5	TA021	TC034 M3x7	BK024	BY041	BSP031	3 Allen
D329	●	DWLNL 2020 K06	125	26	20	25	20	0,436								
D319	●	DWLNL 2525 M06	150	26	25	32	25	0,772								
D316	●	DWLNL 2020 K08	125	32	20	25	20	0,442	WN-- 0804	TC044 M6	TA020-1	TC083 M5x12	BK020	BY040	BSP030	4 Allen
D318	●	DWLNL 2525 M08	150	32	25	32	25	0,793								
D320	●	DWLNL 3232 P08	170	32	32	40	32	1,377								

95° MWLNR

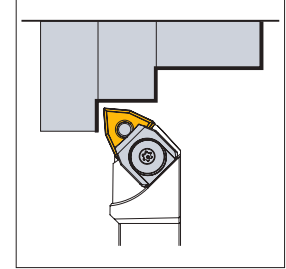
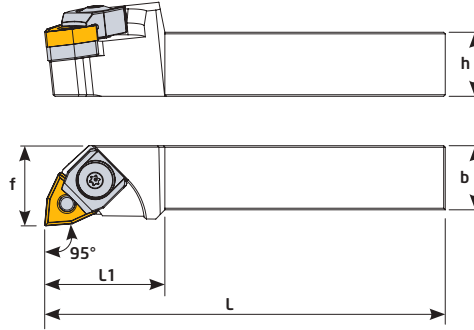

Sipariş Kodu Order Code Best.-Nr.	Stok/Stock/Lager	Ürün Kodu Product Code Produkt-Code	Ölçüler (mm) Dimensions(mm) Abmessungen (mm)							Kullanılan Uç Insert WSP	Baskı Civatası Locking Screw Verriegelungs Schraube	Altlık Shim U-Platte	Altlık Pimi Lock Pin Rohrstift	Baskı Kepi Clamp Spann- pratze	Yay Spring Feder	Pul Washer U-Scheibe	Anahtar Allen Key Inbuss-Schlüssel
			L	L1	h	f	b	kg									
D182	●	MWLNR 2020 K08	125	35	20	25	20	0,435	WN-- 0804	TC044 M6	TA020	BSP021	BK026	BY040	BSP030	4 Allen	
D184	●	MWLNR 2525 M08	150	35	25	32	25	0,761									
D185	●	MWLNR 3232 P08	170	35	32	40	32	1,349									

95° MWLNL

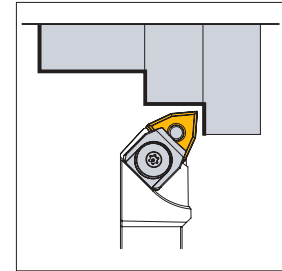
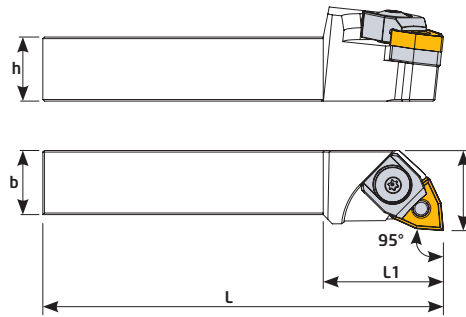

Sipariş Kodu Order Code Best.-Nr.	Stok/Stock/Lager	Ürün Kodu Product Code Produkt-Code	Ölçüler (mm) Dimensions(mm) Abmessungen (mm)							Kullanılan Uç Insert WSP	Baskı Civatası Locking Screw Verriegelungs Schraube	Altlık Shim U-Platte	Altlık Pimi Lock Pin Rohrstift	Baskı Kepi Clamp Spann- pratze	Yay Spring Feder	Pul Washer U-Scheibe	Anahtar Allen Key Inbuss-Schlüssel
			L	L1	h	f	b	kg									
D322	●	MWLNL 2020 K08	125	35	20	25	20	0,435	WN-- 0804	TC044 M6	TA020	BSP021	BK026	BY040	BSP030	4 Allen	
D324	●	MWLNL 2525 M08	150	35	25	32	25	0,761									
D326	●	MWLNL 3232 P08	170	35	32	40	32	1,349									

95° MWMNN

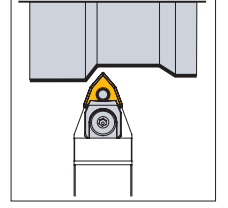
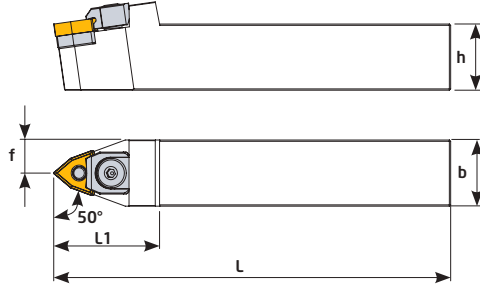

Sipariş Kodu Order Code Best.-Nr.	Stok/Stok/Lager	Ürün Kodu Product Code Produkt-Code	Ölçüler (mm) Dimensions (mm) Abmessungen (mm)					Kullanılan Uç Insert WSP	Baskı Civatası Locking Screw Verriegelungs Schraube	Altlık Shim U-Platte	Altlık Pimi Lock Pin Rohrstift	Baskı Kepi Clamp Spannpratze	Yay Spring Feder	Pul Washer U-Scheibe	Anahtar Allen Key Inbuss-Schlüssel	
			L	L1	h	f	b									kg
D114	●	MWMNN 2020 K08	125	40	20	10	20	0,432	WN-- 0804	TC044 M6	TA020	BSP021	BK026	BY040	BSP030	4 Allen
D116	●	MWMNN 2525 M08	150	40	25	12,5	25	0,724								

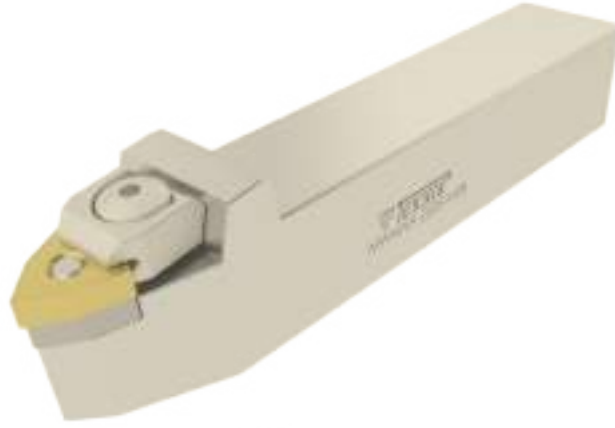

93° MTJNR

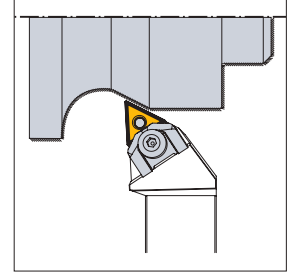
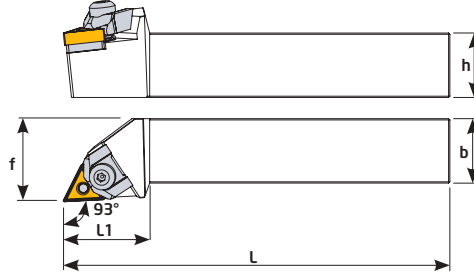

Sipariş Kodu Order Code Best.-Nr.	Stok/Stock/Lager	Ürün Kodu Product Code Produkt-Code	Ölçüler (mm) Dimensions(mm) Abmessungen (mm)							Kullanılan Uç Insert WSP	Baskı Civatası Locking Screw Verriegelungs Schraube	Altlık Shim U-Platte	Altlık Pimi Lock Pin Rohrstift	Baskı Kepi Clamp Spannpratze	Yay Spring Feder	Pul Washer U-Scheibe	Anahtar Allen Key Inbuss-Schlüssel
			L	L1	h	f	b	kg									
D194	●	MTJNR 2020 K16	125	35	20	25	20	0,429	TN-- 1604	TC046 M5	TA019	BSP020	BK022	BY043	BSP031	3 Allen	
D196	●	MTJNR 2525 M16	150	35	25	32	25	0,760									
D198	●	MTJNR 3232 P16	170	35	32	40	32	1,360									
D200	●	MTJNR 2020 K22	125	40	20	25	20	0,429	TN-- 2204	TC044 M6	TA045	BSP021	BK023	BY040	BSP030	4 Allen	
D202	●	MTJNR 2525 M22	150	40	25	32	25	0,775									
D204	●	MTJNR 3232 P22	170	40	32	40	32	1,348									

93° MTJNL

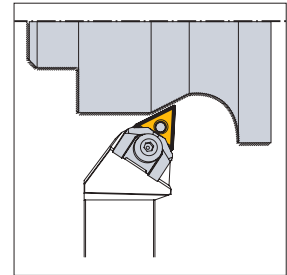
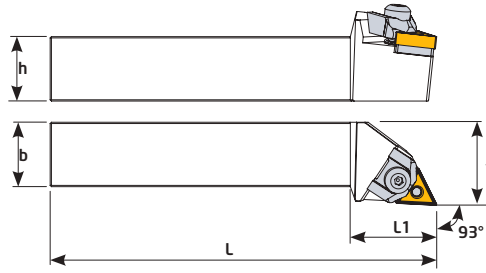

Sipariş Kodu Order Code Best.-Nr.	Stok/Stock/Lager	Ürün Kodu Product Code Produkt-Code	Ölçüler (mm) Dimensions(mm) Abmessungen (mm)							Kullanılan Uç Insert WSP	Baskı Civatası Locking Screw Verriegelungs Schraube	Altlık Shim U-Platte	Altlık Pimi Lock Pin Rohrstift	Baskı Kepi Clamp Spannpratze	Yay Spring Feder	Pul Washer U-Scheibe	Anahtar Allen Key Inbuss-Schlüssel
			L	L1	h	f	b	kg									
D332	●	MTJNL 2020 K16	125	35	20	25	20	0,429	TN-- 1604	TC046 M5	TA019	BSP020	BK022	BY043	BSP031	3 Allen	
D334	●	MTJNL 2525 M16	150	35	25	32	25	0,760									
D336	●	MTJNL 3232 P16	170	35	32	40	32	1,360									
D338	●	MTJNL 2020 K22	125	40	20	25	20	0,429	TN-- 2204	TC044 M6	TA045	BSP021	BK023	BY040	BSP030	4 Allen	
D340	●	MTJNL 2525 M22	150	40	25	32	25	0,775									
D342	●	MTJNL 3232 P22	170	40	32	40	32	1,348									

60° MTENN

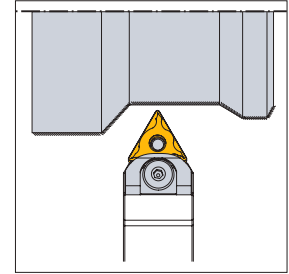
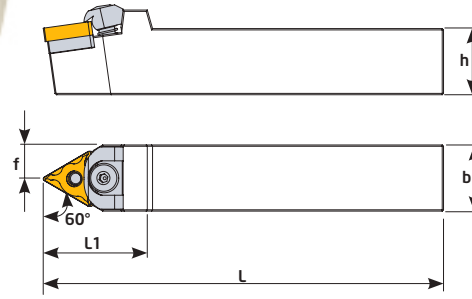

Sipariş Kodu Order Code Best.-Nr.	Stok/Stock/Lager	Ürün Kodu Product Code Produkt-Code	Ölçüler (mm) Dimensions(mm) Abmessungen (mm)					Kullanılan Uç Insert WSP	Baskı Civatası Locking Screw Verriegelungs Schraube	Altlık Shim U-Platte	Altlık Pimi Lock Pin Rohrstift	Baskı Kepi Clamp Spannpratze	Yay Spring Feder	Pul Washer U-Scheibe	Anahtar Allen Key Inbuss-Schlüssel	
			L	L1	h	f	b									KG
D108	●	MTENN 2020 K16	125	35	20	10	20	0,408	TN-- 1604	TC046 M5	TA019	BSP020	BK022	BY043	BSP031	3 Allen
D110	●	MTENN 2525 M16	150	35	25	12.5	25	0,724	TN-- 1604	TC046 M5	TA019	BSP020	BK022	BY043	BSP031	3 Allen
D112	●	MTENN 2525 M22	150	40	25	12.5	25	0,734	TN-- 2204	TC044 M6	TA045	BSP021	BK023	BY040	BSP030	4 Allen
D113	●	MTENN 3232 P22	170	40	32	16	32	1,311	TN-- 2204	TC044 M6	TA045	BSP021	BK023	BY040	BSP030	4 Allen



93° DVJNR

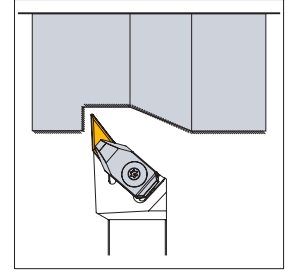
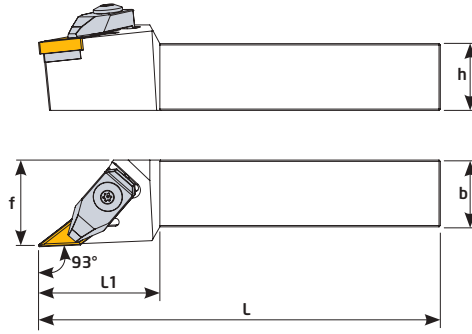

Sipariş Kodu Order Code Best.-Nr.	Stok/Stock/Lager	Ürün Kodu Product Code Produkt-Code	Ölçüler (mm) Dimensions(mm) Abmessungen (mm)							Kullanılan Uç Insert WSP	Baskı Civatası Locking Screw Verriegelungs-Schraube	Altlık Shim U-Platte	Altlık Civatası Shim Screw U-Platte Schraube	Baskı Kepi Clamp Spannpratze	Yay Spring Feder	Pul Washer U-Scheibe	Anahtar Allen Key Inbuss-Schlüssel
			L	L1	h	f	b	Ⓢ									
D105-1	●	DVJNR 2020 K16	125	40	20	27	20	0,428	VN-- 1604	TC046 M5	TA033	TC075 M4x11-50	BK021	BY043	BSP031	3 Allen	
D105	●	DVJNR 2525 M16	150	40	25	32	25	0,427									

93° DVJNL

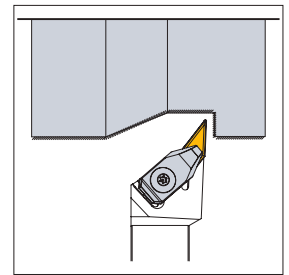
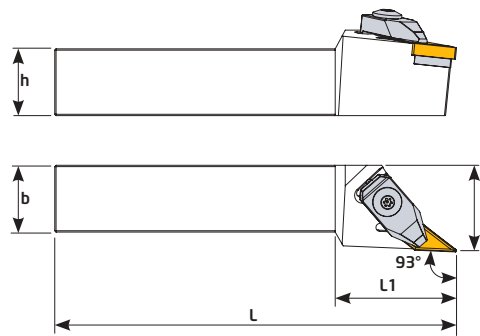

Sipariş Kodu Order Code Best.-Nr.	Stok/Stock/Lager	Ürün Kodu Product Code Produkt-Code	Ölçüler (mm) Dimensions(mm) Abmessungen (mm)							Kullanılan Uç Insert WSP	Baskı Civatası Locking Screw Verriegelungs-Schraube	Altlık Shim U-Platte	Altlık Civatası Shim Screw U-Platte Schraube	Baskı Kepi Clamp Spannpratze	Yay Spring Feder	Pul Washer U-Scheibe	Anahtar Allen Key Inbuss-Schlüssel
			L	L1	h	f	b	Ⓢ									
D343	●	DVJNL 2020 K16	125	40	20	27	20	0,428	VN-- 1604	TC046 M5	TA033	TC075 M4x11-50	BK021	BY043	BSP031	3 Allen	
D344	●	DVJNL 2525 M16	150	40	25	32	25	0,427									

72,5° DVVNN

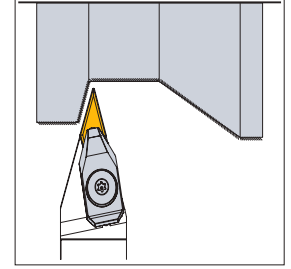
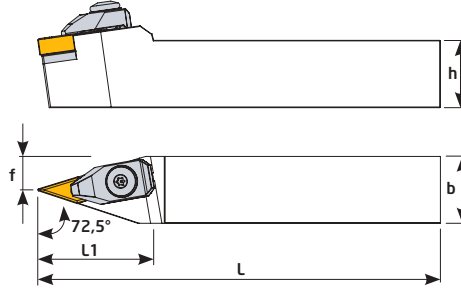

Sipariş Kodu Order Code Best.-Nr.	Stok/Stock/Lager	Ürün Kodu Product Code Produkt-Code	Ölçüler (mm) Dimensions(mm) Abmessungen (mm)						Kullanılan Uç Insert WSP	Baskı Civatası Locking Screw Verriegelungs Schraube	Altlık Shim U-Platte	Altlık Civatası Shim Screw U-Platte Schraube	Baskı Kepi Clamp Spannpratze	Yay Spring Feder	Pul Washer U-Scheibe	Anahtar Allen Key Inbuss-Schlüssel
			L	L1	h	f	b	kg								
D105-2	●	DVVNN 2525 M16	150	45	25	12,5	25	0,690	VN-- 1604	TC046 M5	TA033	TC075 M4x11-50	BK021	BY043	BSP031	3 Allen

93° CKJNR

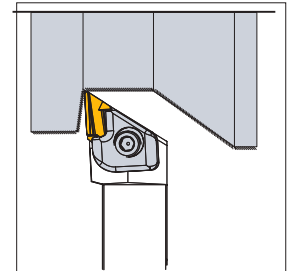
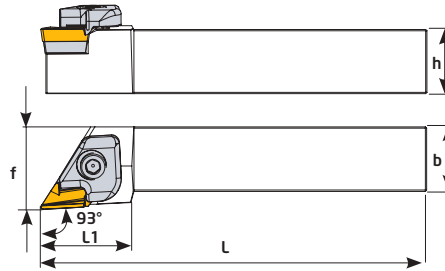

Sipariş Kodu Order Code Best.-Nr.	Stok/Stock/Lager	Ürün Kodu Product Code Produkt-Code	Ölçüler (mm) Dimensions(mm) Abmessungen (mm)						Kullanılan Uç Insert WSP	Baskı Civatası Locking Screw Verriegelungs Schraube	Altlık Shim U-Platte	Altlık Civatası Shim Screw U-Platte Schraube	Baskı Kepi Clamp Spannpratze	Yay Spring Feder	Pul Washer U-Scheibe	Anahtar Allen Key Inbuss-Schlüssel
			L	L1	h	f	b	kg								
RD018	●	CKJNR 2020 K16	125	32	20	27	20	0,434	KNUX 1604	TC044 M6	TA046	TC036 M3x10	BK028	BY042	BSP030	4 Allen
RD014	●	CKJNR 2525 M16	150	35	25	30	25	0,753								
RD013	●	CKJNR 3232 P16	170	35	32	40	32	1,311								

95° DCLNR

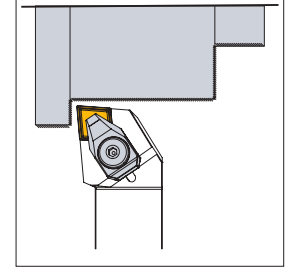
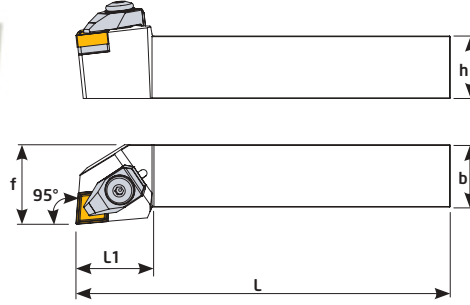

Sipariş Kodu Order Code Best.-Nr.	Stok/Stock/Lager	Ürün Kodu Product Code Produkt-Code	Ölçüler (mm) Dimensions(mm) Abmessungen (mm)							Kullanılan Uç Insert WSP	Aitlik Shim U-Platte	Aitlik Civatası Shim Screw U-Platte Schraube	Baskı Kepi Clamp Spannpratze	Baskı Civatası Locking Screw Verriegelungs Schraube	Yay Spring Feder	Pul Washer U-Scheibe	Anahtar Allen Key Inbuss-Schlüssel
			L	L1	h	f	b	Ⓢ									
D160	●	DCLNR 2020 K12	125	30	20	25	20	0,441	CN-- 1204	TA016-1	TC038 M4x10	BK020	TC044 M6	BY040	BSP030	4 Allen	
D162	●	DCLNR 2525 M12	150	30	25	32	25	0,785									
D164	●	DCLNR 3232 P12	170	30	32	40	32	1,379	CN-- 1606	TA022	TC095 M5x11,8	BK018	TC044 M6	BY040	BSP030		
D162-1	●	DCLNR 2525 M16	150	36	25	32	25	0,432									
D165	●	DCLNR 3232 P16	170	36	32	40	32	1,407	CN-- 1906	TA017	TC039 M6x12	BK025	TC047 M8	BY044	BSP032		
D163	●	DCLNR 2525 M19	150	40	25	32	25	0,820									
D166	●	DCLNR 3232 P19	170	40	32	40	32	1,430	CN-- 1906	TA017	TC039 M6x12	BK025	TC047 M8	BY044	BSP032		
D166-1	●	DCLNR 4040 S19	250	40	40	40	40	3,195									

95° DCLNL

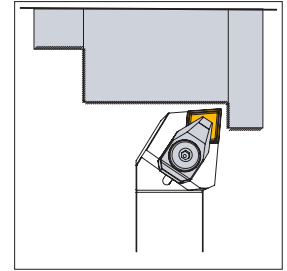
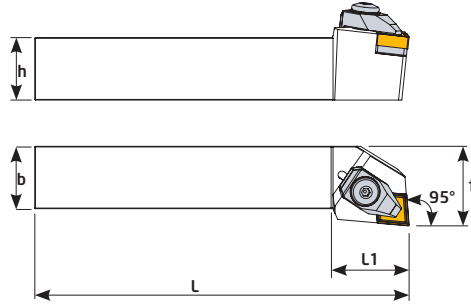

Sipariş Kodu Order Code Best.-Nr.	Stok/Stock/Lager	Ürün Kodu Product Code Produkt-Code	Ölçüler (mm) Dimensions(mm) Abmessungen (mm)							Kullanılan Uç Insert WSP	Aitlik Shim U-Platte	Aitlik Civatası Shim Screw U-Platte Schraube	Baskı Kepi Clamp Spannpratze	Baskı Civatası Locking Screw Verriegelungs Schraube	Yay Spring Feder	Pul Washer U-Scheibe	Anahtar Allen Key Inbuss-Schlüssel
			L	L1	h	f	b	Ⓢ									
D301	●	DCLNL 2020 K12	125	30	20	25	20	0,441	CN-- 1204	TA016-1	TC038 M4x10	BK020	TC044 M6	BY040	BSP030	4 Allen	
D302	●	DCLNL 2525 M12	150	30	25	32	25	0,785									
D305	●	DCLNL 3232 P12	170	30	32	40	32	1,379	CN-- 1606	TA022	TC095 M5x11,8	BK018	TC044 M6	BY040	BSP030		
D303	●	DCLNL 2525 M16	150	36	25	32	25	0,432									
D306	●	DCLNL 3232 P16	170	36	32	40	32	1,407	CN-- 1906	TA017	TC039 M6x12	BK025	TC047 M8	BY044	BSP032		
D304	●	DCLNL 2525 M19	150	40	25	32	25	0,820									
D307	●	DCLNL 3232 P19	170	40	32	40	32	1,430	CN-- 1906	TA017	TC039 M6x12	BK025	TC047 M8	BY044	BSP032		
D307-2	●	DCLNL 4040 S19	250	40	40	40	40	3,195									

50° DCMNN

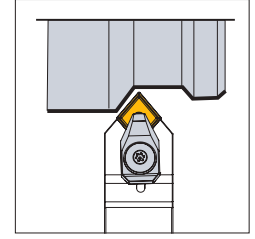
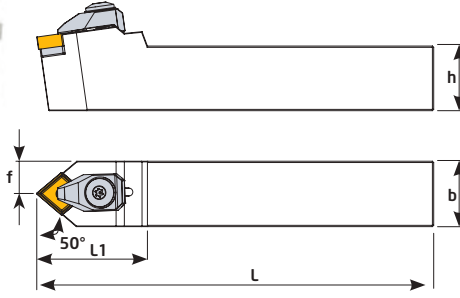

Sipariş Kodu Order Code Best.-Nr.	Stok/Stock/Lager	Ürün Kodu Product Code Produkt-Code	Ölçüler (mm) Dimensions (mm) Abmessungen (mm)						Kullanılan Uç Insert WSP	Baskı Civatası Locking Screw Verriegelungs Schraube	Altlık Shim U-Platte	Altlık Civatası Shim Screw U-Platte Schraube	Baskı Kepi Clamp Spannpratze	Yay Spring Feder	Pul Washer U-Scheibe	Anahtar Allen Key Inbuss-Schlüssel
			L	L1	h	f	b									
D214-1	●	DCMNN 2020 K12	125	35	20	10	20	0,445	CN-- 1204	TC044 M6	TA016	TC038 M4x10	BK020	BY040	BSP030	4 Allen
D215	●	DCMNN 2525 M12	150	42	25	12,5	25	0,778								

45° DCSNR

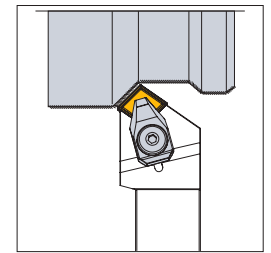
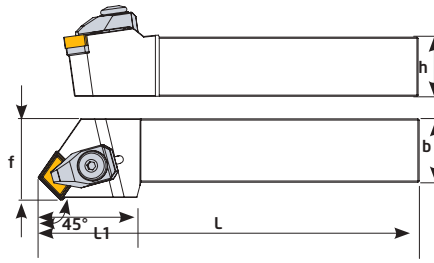

D218	●	DCSNR 2525 M12	150	35	25	32	25	0,774	CN-- 1204	TC044 M6	TA016	TC038 M4x10	BK020	BY040	BSP030	4 Allen
------	---	----------------	-----	----	----	----	----	-------	-----------	----------	-------	-------------	-------	-------	--------	---------

40° DCXNN

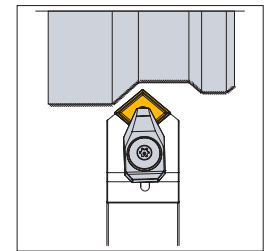
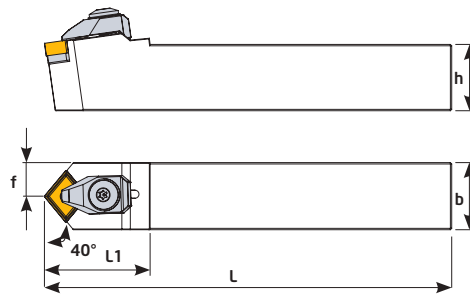

Sipariş Kodu Order Code Best.-Nr.	Stok/Stock/Lager	Ürün Kodu Product Code Produkt-Code	Ölçüler (mm) Dimensions (mm) Abmessungen (mm)						Kullanılan Uç Insert WSP	Baskı Civatası Locking Screw Verriegelungs Schraube	Altlık Shim U-Platte	Altlık Civatası Shim Screw U-Platte Schraube	Baskı Kepi Clamp Spannpratze	Yay Spring Feder	Pul Washer U-Scheibe	Anahtar Allen Key Inbuss-Schlüssel
			L	L1	h	f	b									
D216	●	DCXNN 2525 M12	150	35	25	12,5	25	0,756	CN-- 1204	TC044 M6	TA016	TC038 M4x10	BK020	BY040	BSP030	4 Allen

75° DCKNR

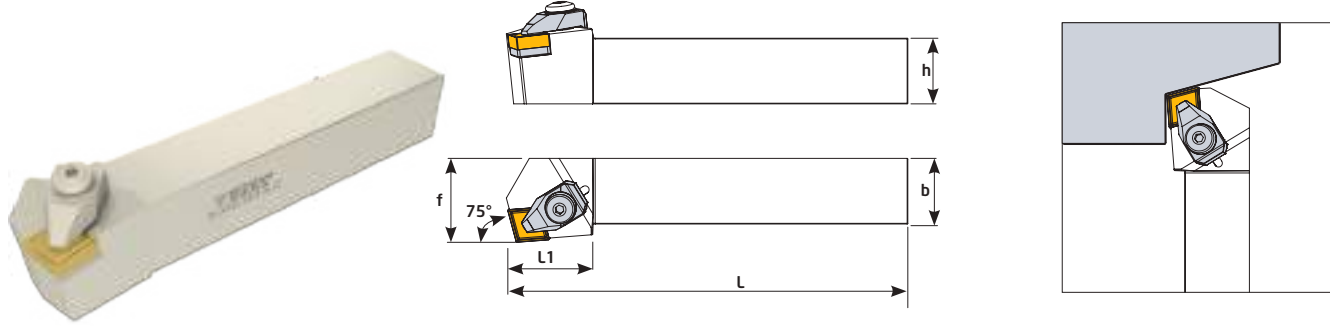

Sipariş Kodu Order Code Best.-Nr.	Stok/Stock/Lager	Ürün Kodu Product Code Produkt-Code	Ölçüler (mm) Dimensions(mm) Abmessungen (mm)							Kullanılan Uç Insert WSP	Altlık Shim U-Platte	Altlık Cıvatası Shim Screw U-Platte Schraube	Baskı Kepi Clamp Spann pratze	Baskı Cıvatası Locking Screw Verriegelungs Schraube	Yay Spring Feder	Pul Washer U-Schei- be	Anahtar Allen Key Inbuss-Schlüs- sel
			L	L1	h	f	b										
D116-1	●	DCKNR 2525 M12	150	30	25	32	25	0,440									
D162-3	●	DCKNR 2525 M16	150	40	25	32	25	0,576									

45° DSSNR

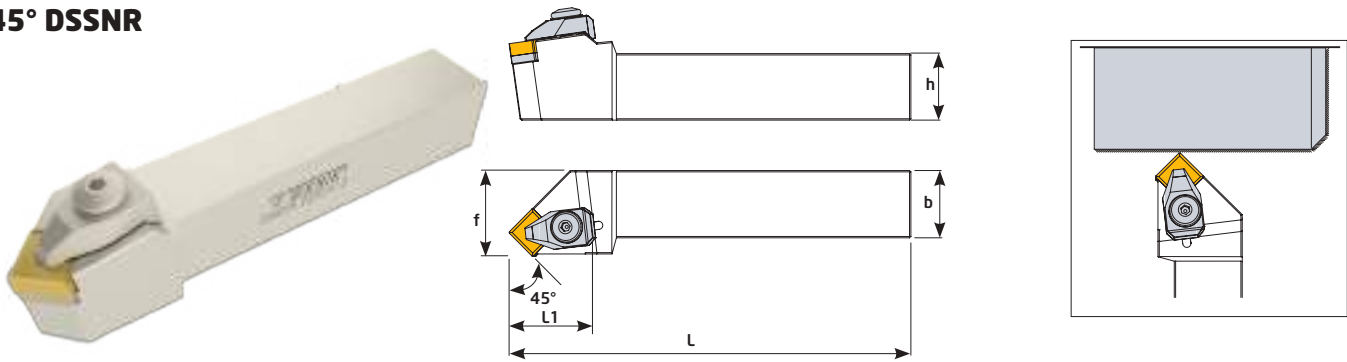

Sipariş Kodu Order Code Best.-Nr.	Stok/Stock/Lager	Ürün Kodu Product Code Produkt-Code	Ölçüler (mm) Dimensions(mm) Abmessungen (mm)							Kullanılan Uç Insert WSP	Altlık Shim U-Platte	Altlık Cıvatası Shim Screw U-Platte Schraube	Baskı Kepi Clamp Spann pratze	Baskı Cıvatası Locking Screw Verriegelungs Schraube	Yay Spring Feder	Pul Washer U-Schei- be	Anahtar Allen Key Inbuss-Schlüssel
			L	L1	h	f	b										
D210	●	DSSNR 2020 K12	125	35	20	25	20	0,440									
D212	●	DSSNR 2525 M12	150	35	25	32	25	0,576									
D205	●	DSSNR 3232 P12	170	36	32	32	40	1,280									
D206	●	DSSNR 3232 P19	170	46	32	32	40	1,383									
D207	●	DSSNR 4040 S19	250	46	40	40	50	3,123									
D208	●	DSSNR 4040 S25	250	60	40	40	50	3,012									

Dış Çap Dış Kateri/R

External Threading Toolholders/R

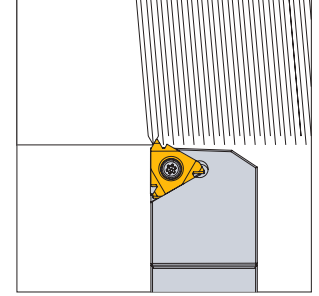
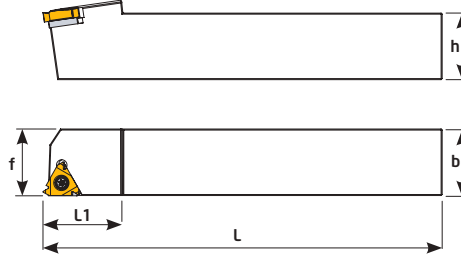

Sipariş Kodu Order Code Best.-Nr.	Stok/Stock/Lager	Ürün Kodu Product Code Produkt-Code	Ölçüler (mm) Dimensions(mm) Abmessungen (mm)						Kullanılan Uç Insert WSP	Sıkma Civatası Clamp Screw Torx-Schraube	Altık Shim U-Platte	Altık Civatası Shim Screw U-Platte Schraube	Anahtar Torx Key Torx-Schlüssel
			L	L1	h	f	b						
D261	●	AL 1212 J16- ER16	110	20	12	16	12	0,144					
D259	●	AL 1616 H16- ER16	100	22	16	16	0,250						
D258	●	AL 2020 K16- ER16	125	25	20	20	0,416						
D260	●	AL 2525 M16- ER16	150	30	25	25	0,754						
D262	●	AL 3232 P16- ER16	170	30	32	32	1,436						
D266	●	AL 2525 M22- ER22	150	30	25	25	0,748	22 ER	TC075 M4x11	---	---	T15	

Dış Çap Dış Kateri/L

External Threading Toolholders/L

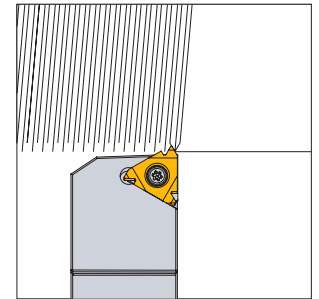
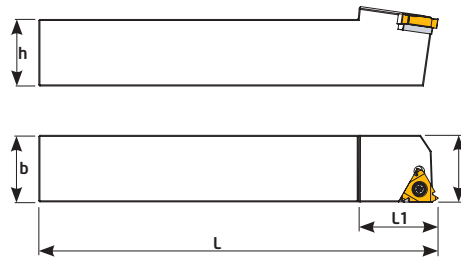

Sipariş Kodu Order Code Best.-Nr.	Stok/Stock/Lager	Ürün Kodu Product Code Produkt-Code	Ölçüler (mm) Dimensions(mm) Abmessungen (mm)						Kullanılan Uç Insert WSP	Sıkma Civatası Clamp Screw Torx-Schraube	Altık Shim U-Platte	Altık Civatası Shim Screw U-Platte Schraube	Anahtar Torx Key Torx-Schlüssel
			L	L1	h	f	b						
D268	●	AL 2020 K16- IR16	125	25	20	20	0,416						
D269	●	AL 2525 M16- IR16	150	30	25	25	0,754						
D266-1	●	AL 2525 M22- IR22	150	30	25	25	0,748						22 IR

İç Çap Dış Kateri/R

Internal Threading Toolholders/R

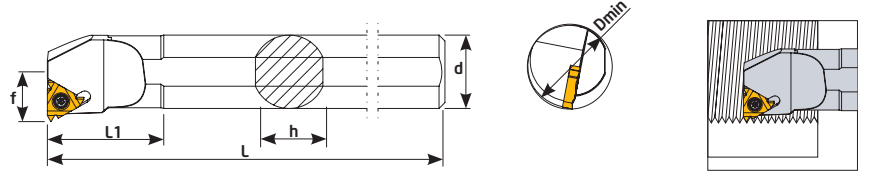

Sipariş Kodu Order Code Best.-Nr.	Stok/Stock/Lager	Ürün Kodu Product Code Produkt-Code	Ölçüler (mm) Dimensions(mm) Abmessungen (mm)							Kullanılan Uç Insert WSP	Sıkma Civatası Clamp Screw Torx-Schraube	Anahtar Torx Key Torx-Schlüssel
			Dmin	d	L	L1	f	h	☺			
K348	●	S10J STIR- IR11	12	10	110	20	6	9	0,079	11 IR	TC060 M2,5x5,5	T8
K350	●	S12K STIR- IR11	14	12	125	25	7,2	11	0,117			
K352	●	S16Q STIR- IR16	20	16	180	40	11	15	0,286	16 IR	TC069 M3,5x8,5	T10
K354	●	S20Q STIR- IR16	25	20	180	40	13	18	0,436			
K356	●	S25R STIR- IR16	29	25	200	40	16	23	0,762			
K358	●	S32T STIR- IR16	36	32	300	60	19,5	30	1,829	22 IR	TC075 M4x11	T15
K358-1	●	S20Q STIR- IR22	24	20	180	40	14	18	0,431			
K359	●	S25R STIR- IR22	32	25	200	40	17	23	0,757			
K360	●	S32T STIR- IR22	36	32	300	60	19,5	30	1,818			
K360-1	●	S40T STIR- IR22	45	40	300	60	24,5	38	2,831			

İç Çap Dış Kateri/L

Internal Threading Toolholders/L

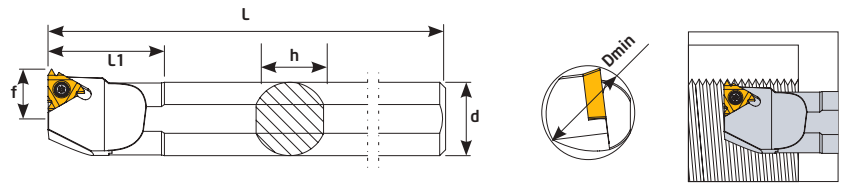

Sipariş Kodu Order Code Best.-Nr.	Stok/Stock/Lager	Ürün Kodu Product Code Produkt-Code	Ölçüler (mm) Dimensions(mm) Abmessungen (mm)							Kullanılan Uç Insert WSP	Sıkma Civatası Clamp Screw Torx-Schraube	Anahtar Torx Key Torx-Schlüssel
			Dmin	d	L	L1	f	h	☺			
K360-2	●	S10J STIL-ER11	12	10	110	20	6	9	0,079	11 IR	TC060 M2,5x5,5	T8
K361	●	S16Q STIL-ER16	20	16	180	40	11	15	0,286			
K362	●	S20Q STIL-ER16	25	20	180	40	13	18	0,436	16 ER	TC069 M3,5x8,5	T10
K363	●	S25R STIL-ER16	29	25	200	40	16	23	0,762			

● Stokta/ In Stock/ Lager ○ Sınırlı Stok/ Limited Stock/ Begrenzte Lagerhaltung

Dış Çap Dış Kateri/R

External Threading Toolholders/R

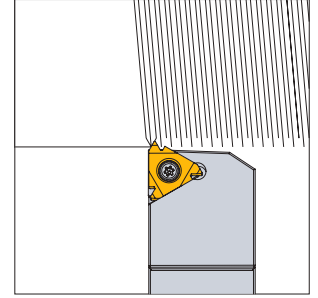
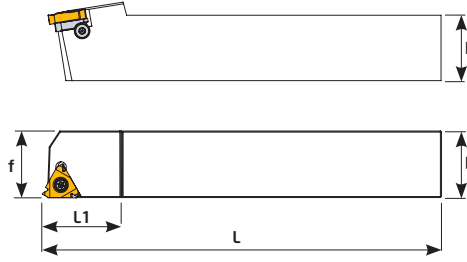

Sipariş Kodu Order Code Best.-Nr.	Stok/Stock/Lager	Ürün Kodu Product Code Produkt-Code	Ölçüler (mm) Dimensions(mm) Abmessungen (mm)						Kullanılan Uç Insert WSP	Sıkma Cıvatası Clamp Screw Torx-Schraube	Altlık Shim U-Platte	Pul Washer U-Scheibe	Altlık Cıvatası Shim Screw U-Platte Schraube	Anahtar Torx Key Torx-Schlüssel
			L	L1	h	f	b	kg						
D500	●	TAL 1212 J16- ER16	110	22	12	16	12	0,119	16 ER	TC070 M3,5x11	TA061	BSP010	TC062 M3	T10
D501	●	TAL 1616 H16- ER16	100	25	16	16	0,223							
D502	●	TAL 2020 K16- ER16	125	30	20	20	0,414							
D503	●	TAL 2525 M16- ER16	150	30	25	25	0,753							
D504	●	TAL 3232 P16- ER16	170	30	32	32	1,417							
D505	●	TAL 2525 M22- ER22	150	30	25	25	0,749	22 ER	TC076 M4x12,5	TA062	TC062 M3	T15		
D506	●	TAL 3232 P22- ER22	170	36	32	32	1,434							

Dış Çap Dış Kateri/L

External Threading Toolholders/L

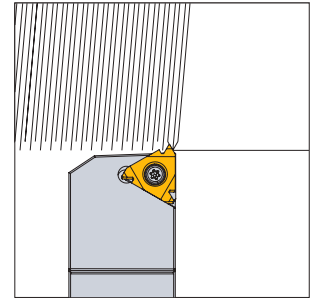
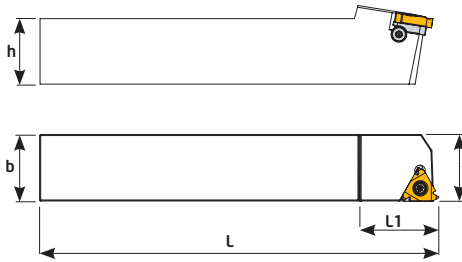

Sipariş Kodu Order Code Best.-Nr.	Stok/Stock/Lager	Ürün Kodu Product Code Produkt-Code	Ölçüler (mm) Dimensions(mm) Abmessungen (mm)						Kullanılan Uç Insert WSP	Sıkma Cıvatası Clamp Screw Torx-Schraube	Altlık Shim U-Platte	Pul Washer U-Scheibe	Altlık Cıvatası Shim Screw U-Platte Schraube	Anahtar Torx Key Torx-Schlüssel
			L	L1	h	f	b	kg						
D508	●	TAL 1212-L J16- IR16	110	22	12	16	12	0,119	16 IR	TC070 M3,5x11	TA060	BSP010	TC062 M3	T10
D509	●	TAL 1616-L H16- IR16	100	25	16	16	0,223							
D510	●	TAL 2020-L K16- IR16	125	30	20	20	0,414							
D511	●	TAL 2525-L M16- IR16	150	30	25	25	0,753							
D512	●	TAL 3232-L P16- IR16	150	30	32	32	1,417							
D513	●	TAL 2525-L M22- IR22	150	30	25	25	0,749	22 IR	TC076 M4x12,5	TA063	TC062 M3	T15		
D515	●	TAL 3232-L P22- IR22	170	36	32	32	1,434							

95° SCLCR

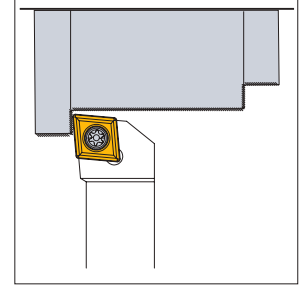
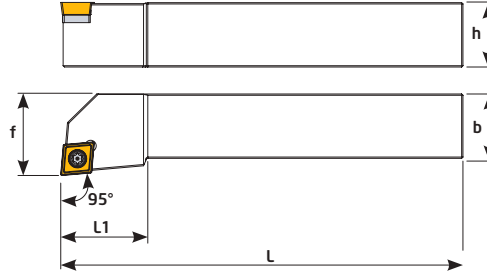

Sipariş Kodu Order Code Best.-Nr.	Stok/Stock/Lager	Ürün Kodu Product Code Produkt-Code	Ölçüler (mm) Dimensions(mm) Abmessungen (mm)							Kullanılan Uç Insert WSP	Sıkma Cıvatası Clamp Screw Torx-Schraube	Altlık Shim U-Platte	Altlık Cıvatası Shim Screw U-Platte Schraube	Anahtar Torx Key Torx-Schlüssel
			L	L1	h	f	b	kg						
D398	●	SCLCR 1010 J06	110	10	10	12	10	0,105	CC-- 0602	TC060 M2,5x5,5	---	---	T8	
D400	●	SCLCR 1212 J09	110	16	12	16	12	0,140	CC-- 09T3	TC068 M3,5x11	TA015	TC048 M5		
D401	●	SCLCR 1616 H09	100	20	16	20	16	0,215						
D402	●	SCLCR 2020 K09	125	25	20	25	20	0,425						
D403	●	SCLCR 2525 M09	150	25	25	32	25	0,772	CC-- 1204	ST411-60F M4x11	TA015-1	SHS610F M6	T15	
D418	●	SCLCR 2020 K12	125	25	20	25	20	0,421						
D403-1	●	SCLCR 2525 M12	150	25	25	32	25	0,768						

95° SCLCL

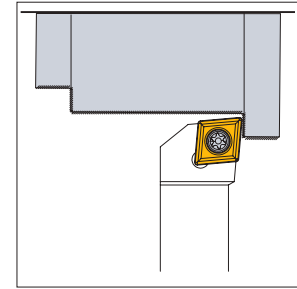
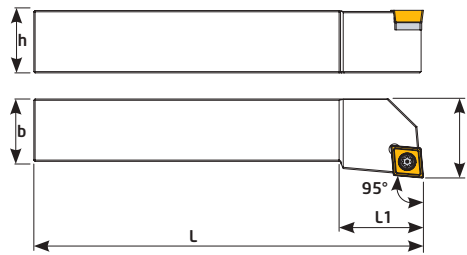

Sipariş Kodu Order Code Best.-Nr.	Stok/Stock/Lager	Ürün Kodu Product Code Produkt-Code	Ölçüler (mm) Dimensions(mm) Abmessungen (mm)							Kullanılan Uç Insert WSP	Sıkma Cıvatası Clamp Screw Torx-Schraube	Altlık Shim U-Platte	Altlık Cıvatası Shim Screw U-Platte Schraube	Anahtar Torx Key Torx-Schlüssel
			L	L1	h	f	b	kg						
D404	●	SCLCL 1010 J06	110	10	10	12	10	0,105	CC-- 0602	TC060 M2,5x5,5	---	---	T8	
D405	●	SCLCL 1212 J09	110	16	12	16	12	0,140	CC-- 09T3	TC068 M3,5x11	TA015	TC048 M5		
D406	●	SCLCL 1616 H09	100	20	16	20	16	0,215						
D407	●	SCLCL 2020 K09	125	25	20	25	20	0,425						
D408	●	SCLCL 2525 M09	150	25	25	32	25	0,772	CC-- 1204	ST411-60F M4x11	TA015-1	SHS610F M6	T15	
D420	●	SCLCL 2020 K12	125	25	20	25	20	0,421						
D421	●	SCLCL 2525 M12	150	25	25	32	25	0,768						

90° SCACR-F

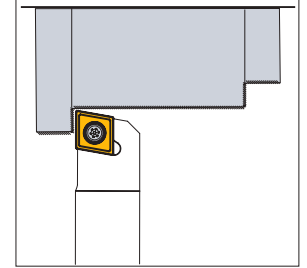
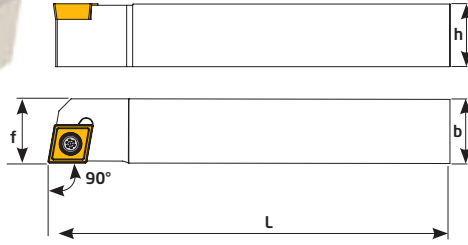

Sipariş Kodu Order Code Best.-Nr.	Stok/Stock/Lager	Ürün Kodu Product Code Produkt-Code	Ölçüler (mm) Dimensions(mm) Abmessungen (mm)					Kullanılan Uç Insert WSP	Altlık Shim U-Platte	Altlık Cıvatası Shim Screw U-Platte Schraube	Sıkma Cıvatası Clamp Screw Torx-Schraube	Anahtar Torx Key Torx-Schlüssel
			L	h	f	b	kg					
D411	●	SCACR 1010 J06-F	110	10	10	10	0,104	CCMT 0602	---	---	TC060 M2,5x5,5	T8
D412	●	SCACR 1212 J09-F	110	12	12	12	0,143	CCMT 09T3	TA015	TC048 M5	TC067 M3,5x8,5	T15
D414	●	SCACR 1616 H09-F	100	16	16	16	0,221				TC068 M3,5x11	
D416	●	SCACR 2020 K09-F	125	20	20	20	0,420					

95° SCLCR -F

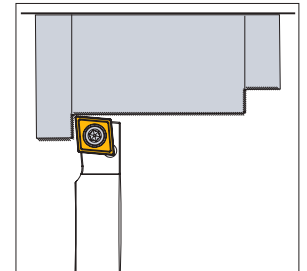
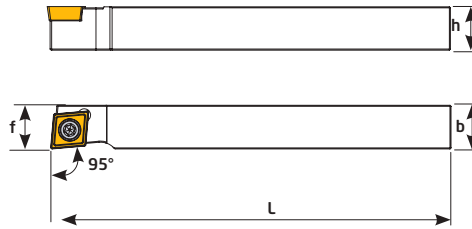

Sipariş Kodu Order Code Best.-Nr.	Stok/Stock/Lager	Ürün Kodu Product Code Produkt-Code	Ölçüler (mm) Dimensions(mm) Abmessungen (mm)					Kullanılan Uç Insert WSP	Altlık Shim U-Platte	Altlık Cıvatası Shim Screw U-Platte Schraube	Sıkma Cıvatası Clamp Screw Torx-Schraube	Anahtar Torx Key Torx-Schlüssel
			L	h	f	b	kg					
D422	●	SCLCR 1010 J06-F	110	10	10	10	0,106	CCMT 0602	---	---	TC060 M2,5x5,5	T8
D424	●	SCLCR 1212 J06-F	110	12	12	12	0,147	CCMT 09T3	TA015	TC048 M5	TC068 M3,5x11	T15
D426	●	SCLCR 1212 J09-F	110	12	12	12	0,144					
D428	●	SCLCR 1616 H09-F	100	16	16	16	0,224					
D430	●	SCLCR 2020 K09-F	125	20	20	20	0,426					

93° SDJCR

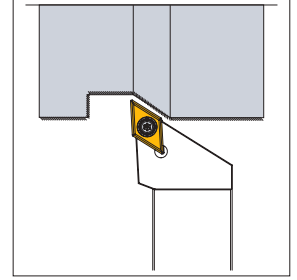
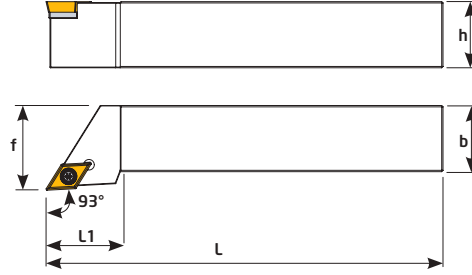

Sipariş Kodu Order Code Best.-Nr.	Stok/Stock/Lager	Ürün Kodu Product Code Produkt-Code	Ölçüler (mm) Dimensions(mm) Abmessungen (mm)							Kullanılan Uç Insert WSP	Sıkma Cıvatası Clamp Screw Torx-Schraube	Altlık Shim U-Platte	Altlık Cıvatası Shim Screw U-Platte Schraube	Anahtar Torx Key Torx-Schlüssel
			L	L1	h	f	b	kg						
D220	●	SDJCR 1010 J07	110	15	10	12	10	0,097	DCMT 0702	TC060 M2,5x5,5	---	---	T8	
D222	●	SDJCR 1212 J11	110	20	12	16	12	0,132	DCMT 11T3	TC067 M3,5x8,5	---	---	T15	
D224	●	SDJCR 1616 H11	100	25	16	20	16	0,204		TC068 M3,5x11	TA030	TC048 M5		
D226	●	SDJCR 2020 K11	125	25	20	25	20	0,404						
D228	●	SDJCR 2525 M11	150	30	25	32	25	0,735						

93° SDJCL

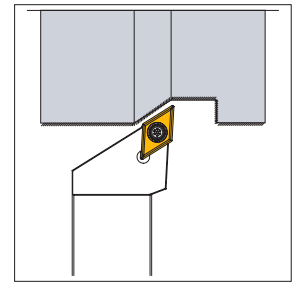
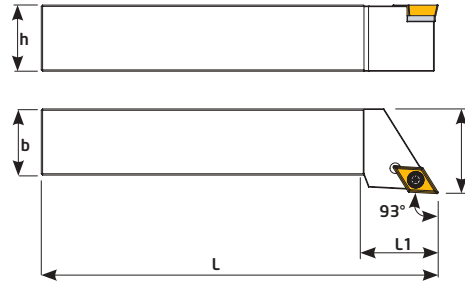

Sipariş Kodu Order Code Best.-Nr.	Stok/Stock/Lager	Ürün Kodu Product Code Produkt-Code	Ölçüler (mm) Dimensions(mm) Abmessungen (mm)							Kullanılan Uç Insert WSP	Sıkma Cıvatası Clamp Screw Torx-Schraube	Altlık Shim U-Platte	Altlık Cıvatası Shim Screw U-Platte Schraube	Anahtar Torx Key Torx-Schlüssel
			L	L1	h	f	b	kg						
D360	●	SDJCL 1010 J07	110	15	10	12	10	0,097	DCMT 0702	TC060 M2,5x5,5	---	---	T8	
D362	●	SDJCL 1212 J11	110	20	12	16	12	0,132	DCMT 11T3	TC067 M3,5x8,5	---	---	T15	
D364	●	SDJCL 1616 H11	100	25	16	20	16	0,204		TC068 M3,5x11	TA030	TC048 M5		
D366	●	SDJCL 2020 K11	125	25	20	25	20	0,404						
D368	●	SDJCL 2525 M11	150	30	25	32	25	0,735						

62,5° SDNCN

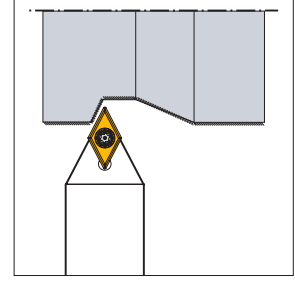
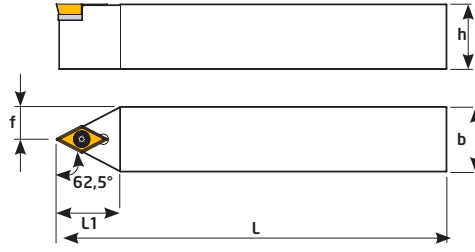

Sipariş Kodu Order Code Best.-Nr.	Stok/Stock/Lager	Ürün Kodu Product Code Produkt-Code	Ölçüler (mm) Dimensions(mm) Abmessungen (mm)					Kullanılan Uç Insert WSP	Sıkma Cıvatası Clamp Screw Torx-Schraube	Altlık Shim U-Platte	Altlık Cıvatası Shim Screw U-Platte Schraube	Anahtar Torx Key Torx-Schlüssel	
			L	L1	h	f	b						kg
D117	●	SDNCN 1010 J07	110	15	10	5	10	0,096	DC-- 0702	TC060 M2,5x5,5	---	---	T8
D118	●	SDNCN 1212 J11	110	25	12	6	12	0,131	DC-- 11T3	TC067 M3,5x8,5	---	---	T15
D120	●	SDNCN 1616 H11	100	25	16	8	16	0,196	DC-- 11T3	TC068 M3,5x11	TA030	TC048 M5	
D122	●	SDNCN 2020 K11	125	25	20	10	20	0,390					
D124	●	SDNCN 2525 M11	150	25	25	12,5	25	0,705					



90° SDACR-F

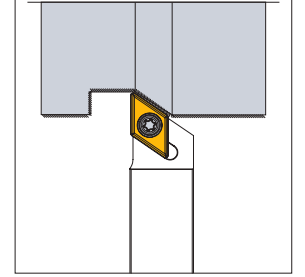
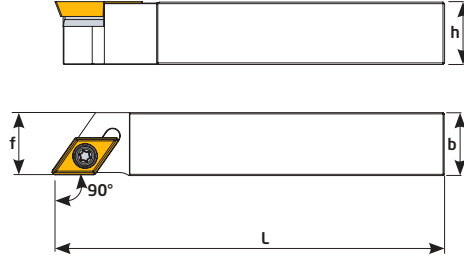

Sipariş Kodu Order Code Best.-Nr.	Stok/Stock/Lager	Ürün Kodu Product Code Produkt-Code	Ölçüler (mm) Dimensions(mm) Abmessungen (mm)					Kullanılan Uç Insert WSP	Sıkma Cıvatası Clamp Screw Torx-Schraube	Altlık Shim U-Platte	Altlık Cıvatası Shim Screw U-Platte Schraube	Anahtar Torx Key Torx-Schlüssel
			L	h	f	b	⊕					
D434	●	SDACR 1010 J07-F	110	10	10	10	0,970	DCMT 0702	TC060 M2,5x5,5	---	---	T8
D436	●	SDACR 1212 J07-F	110	12	12	12	0,135					
D438	●	SDACR 1616 H07-F	100	16	16	16	0,207					
D440	●	SDACR 1212 J11-F	110	12	12	12	0,135	DCMT 11T3	TC067 M3,5x8,5	TA030	TC048 M5	T15
D442	●	SDACR 1616 H11-F	100	16	16	16	0,200					
D444	●	SDACR 2020 K11-F	125	20	20	20	0,397					

93° SDJCR-F

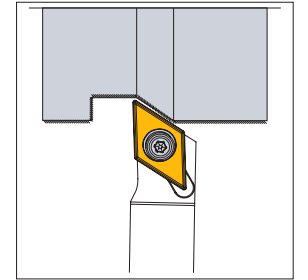
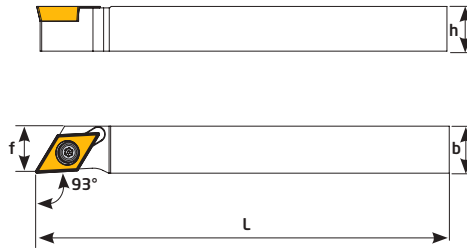

Sipariş Kodu Order Code Best.-Nr.	Stok/Stock/Lager	Ürün Kodu Product Code Produkt-Code	Ölçüler (mm) Dimensions(mm) Abmessungen (mm)					Kullanılan Uç Insert WSP	Sıkma Cıvatası Clamp Screw Torx-Schraube	Anahtar Torx Key Torx-Schlüssel
			L	h	f	b	⊕			
D452	●	SDJCR 1010 J07-F	110	10	10	10	0,103	DCMT 0702	TC060 M2,5x5,5	T8
D454	●	SDJCR 1212 J07-F	110	12	12	12	0,131			
D456	●	SDJCR 1616 H07-F	100	16	16	16	0,192			
D457	●	SDJCR 1212 J11-F	110	12	12	12	0,134	DCMT 11T3	TC067 M3,5x8,5	

107,5° SDHCR

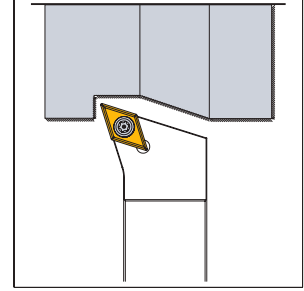
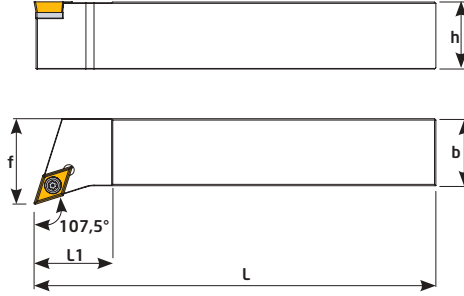

Sipariş Kodu Order Code Best.-Nr.	Stok/Stock/Lager	Ürün Kodu Product Code Produkt-Code	Ölçüler (mm) Dimensions(mm) Abmessungen (mm)						Kullanılan Uç Insert WSP	Sıkma Civatası Clamp Screw Torx-Schraube	Altık Shim U-Platte	Altık Civatası Shim Screw U-Platte Schraube	Anahtar Torx Key Torx-Schlüssel
			L	L1	h	f	b	kg					
D250	●	SDHCR 2020 K11	125	25	20	25	20	0,411	DCMT 11T3	TC068 M3,5x11	TA030	TC048 M5	T15
D252	●	SDHCR 2525 M11	150	25	25	32	25	0,738					

107,5° SDHCL

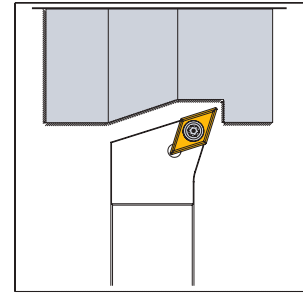
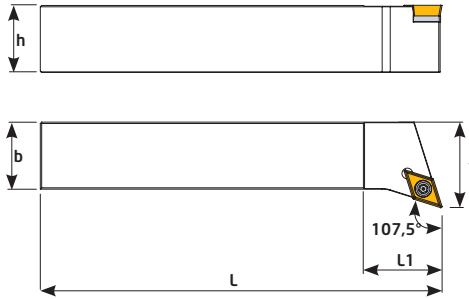

Sipariş Kodu Order Code Best.-Nr.	Stok/Stock/Lager	Ürün Kodu Product Code Produkt-Code	Ölçüler (mm) Dimensions(mm) Abmessungen (mm)						Kullanılan Uç Insert WSP	Sıkma Civatası Clamp Screw Torx-Schraube	Altık Shim U-Platte	Altık Civatası Shim Screw U-Platte Schraube	Anahtar Torx Key Torx-Schlüssel
			L	L1	h	f	b	kg					
D350	●	SDHCL 2020 K11	125	25	20	25	20	0,411	DCMT 11T3	TC068 M3,5x11	TA030	TC048 M5	T15
D352	●	SDHCL 2525 M11	150	25	25	32	25	0,738					

107,5° SVHCR

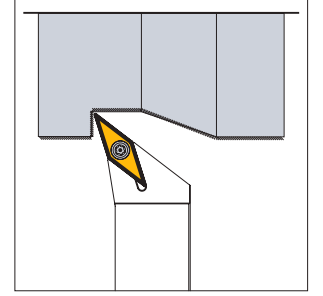
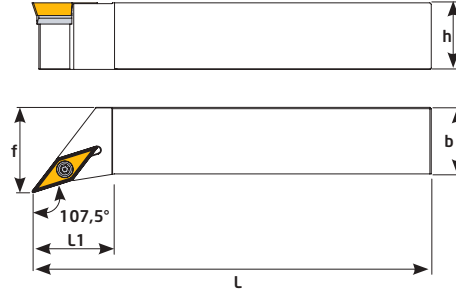

Sipariş Kodu Order Code Best.-Nr.	Stok/Stock/Lager	Ürün Kodu Product Code Produkt-Code	Ölçüler (mm) Dimensions(mm) Abmessungen (mm)						Kullanılan Uç Insert WSP	Sıkma Civatası Clamp Screw Torx-Schraube	Altlık Shim U-Platte	Altlık Civatası Shim Screw U-Platte Schraube	Anahtar Torx Key Torx-Schlüssel
			L	L1	h	f	b						
D254	●	SVHCR 2020 K16	125	30	20	25	20	0,384	VCMT 1604	TC068 M3,5x11	TA034	TC048 M5	T15
D256	●	SVHCR 2525 M16	150	30	25	32	25	0,707					

107,5° SVHCL

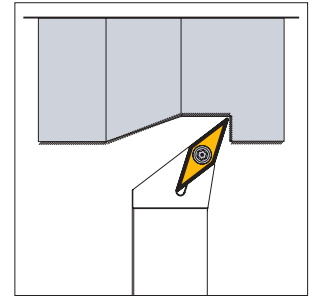
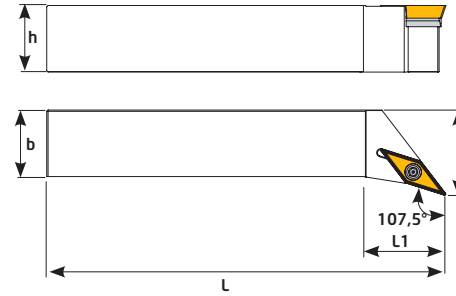

Sipariş Kodu Order Code Best.-Nr.	Stok/Stock/Lager	Ürün Kodu Product Code Produkt-Code	Ölçüler (mm) Dimensions(mm) Abmessungen (mm)						Kullanılan Uç Insert WSP	Sıkma Civatası Clamp Screw Torx-Schraube	Altlık Shim U-Platte	Altlık Civatası Shim Screw U-Platte Schraube	Anahtar Torx Key Torx-Schlüssel
			L	L1	h	f	b						
D354	●	SVHCL 2020 K16	125	30	20	25	20	0,384	VCMT 1604	TC068 M3,5x11	TA034	TC048 M5	T15
D356	●	SVHCL 2525 M16	150	30	25	32	25	0,707					

107,5 SVHBR

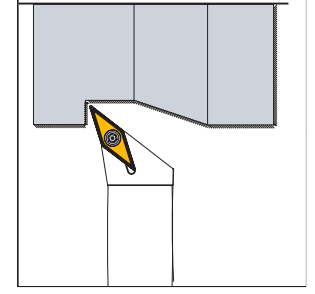
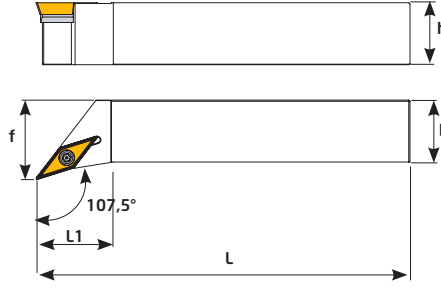

Sipariş Kodu Order Code Best.-Nr.	Stok/Stock/Lager	Ürün Kodu Product Code Produkt-Code	Ölçüler (mm) Dimensions(mm) Abmessungen (mm)						Kullanılan Uç Insert WSP	Sıkma Cıvatası Clamp Screw Torx-Schraube	Altlık Shim U-Platte	Altlık Cıvatası Shim Screw U-Platte Schraube	Anahtar Torx Key Torx-Schlüssel
			L	L1	h	f	b	kg					
D354-1	●	SVHBR 2020 K16	125	30	20	25	20	0,387	VBMT 1604	TC068 M3,5x11	TA034	TC048 M5	T15
D356-1	●	SVHBR 2525 M16	150	30	25	32	25	0,712					

107,5 SVHBL

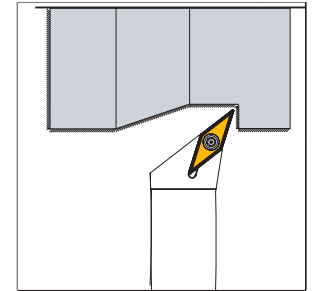
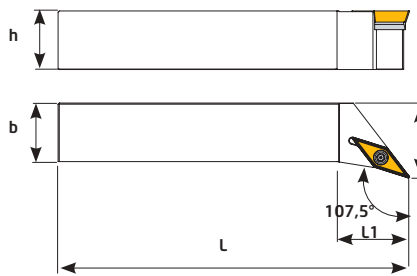

Sipariş Kodu Order Code Best.-Nr.	Stok/Stock/Lager	Ürün Kodu Product Code Produkt-Code	Ölçüler (mm) Dimensions(mm) Abmessungen (mm)						Kullanılan Uç Insert WSP	Sıkma Cıvatası Clamp Screw Torx-Schraube	Altlık Shim U-Platte	Altlık Cıvatası Shim Screw U-Platte Schraube	Anahtar Torx Key Torx-Schlüssel
			L	L1	h	f	b	kg					
D355	●	SVHBL 2020 K16	125	30	20	25	20	0,387	VBMT 1604	TC068 M3,5x11	TA034	TC048 M5	T15
D356-2	●	SVHBL 2525 M16	150	30	25	32	25	0,712					

93° SVJBR

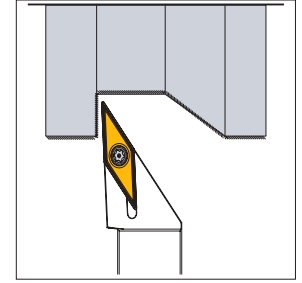
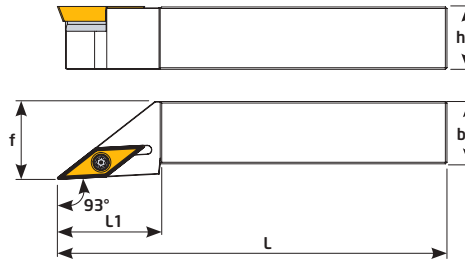

Sipariş Kodu Order Code Best.-Nr.	Stok/Stok/Lager	Ürün Kodu Product Code Produkt-Code	Ölçüler (mm) Dimensions(mm) Abmessungen (mm)							Kullanılan Uç Insert WSP	Sıkma Cıvatası Clamp Screw Torx-Schraube	Altlık Shim U-Platte	Altlık Cıvatası Shim Screw U-Platte Schraube	Anahtar Torx Key Torx-Schlüssel
			L	L1	h	f	b	KG						
D230	●	SVJBR 1010 J11	110	21	10	12	10	0,097	VBMT 1103	TC061 M2,5x6,5	---	---	T8	
D232	●	SVJBR 1212 J11	110	21	12	16	12	0,141						
D234	●	SVJBR 1616 H11	100	25	16	20	16	0,192						
D235	●	SVJBR 1616 H16	100	33	16	20	16	0,192	VBMT 1604	TC068 M3,5x11	TA034	TC048 M5	T15	
D236	●	SVJBR 2020 K16	125	33	20	25	20	0,382						
D238	●	SVJBR 2525 M16	150	40	25	32	25	0,688						
D238-1	●	SVJBR 3232 P16	170	40	32	40	32	1,370						

93° SVJBL

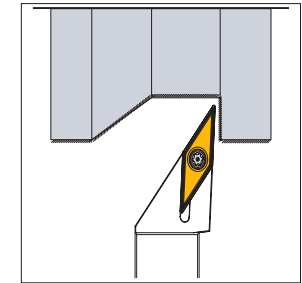
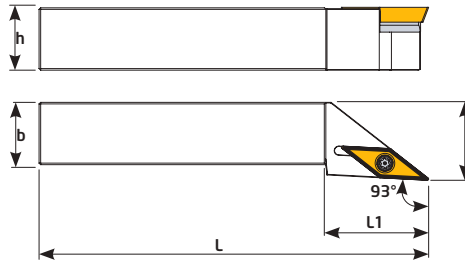

Sipariş Kodu Order Code Best.-Nr.	Stok/Stok/Lager	Ürün Kodu Product Code Produkt-Code	Ölçüler (mm) Dimensions(mm) Abmessungen (mm)							Kullanılan Uç Insert WSP	Sıkma Cıvatası Clamp Screw Torx-Schraube	Altlık Shim U-Platte	Altlık Cıvatası Shim Screw U-Platte Schraube	Anahtar Torx Key Torx-Schlüssel
			L	L1	h	f	b	KG						
D370	●	SVJBL 1010 J11	110	21	10	12	10	0,097	VBMT 1103	TC061 M2,5x6,5	---	---	T8	
D372	●	SVJBL 1212 J11	110	21	12	16	12	0,141						
D373	●	SVJBL 1616 H11	100	25	16	20	16	0,192						
D374	●	SVJBL 1616 H16	100	33	16	20	16	0,192	VBMT 1604	TC068 M3,5x11	TA034	TC048 M5	T15	
D380	●	SVJBL 2020 K16	125	33	20	25	20	0,382						
D382	●	SVJBL 2525 M16	150	40	25	32	25	0,688						
D382-1	●	SVJBL 3232 P16	170	40	32	40	32	1,370						

72,5° SVVBN

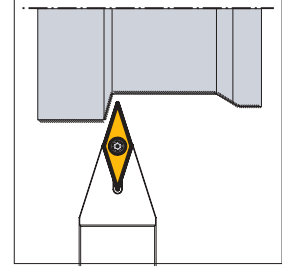
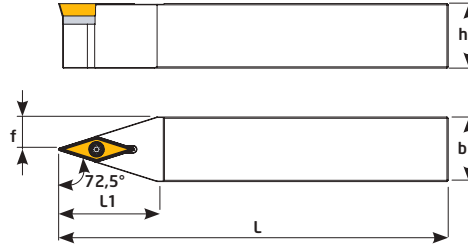

Sipariş Kodu Order Code Best.-Nr.	Stok/Stock/Lager	Ürün Kodu Product Code Produkt-Code	Ölçüler (mm) Dimensions(mm) Abmessungen (mm)							Kullanılan Uç Insert WSP	Sıkma Cıvatası Clamp Screw Torx-Schraube	Altlık Shim U-Platte	Altlık Cıvatası Shim Screw U-Platte Schraube	Anahtar Torx Key Torx-Schlüssel
			L	L1	h	f	b							
D131	●	SVVBN 1212 J11	110	25	12	6	12	0,129	VBMT 1103	TC061 M2,5x6,5	---	---	T8	
D132	●	SVVBN 1616 H16	100	33	16	8	16	0,184	VBMT 1604	TC068 M3,5x11	TA034	TC048 M5	T15	
D138	●	SVVBN 2020 K16	125	35	20	10	20	0,370						
D140	●	SVVBN 2525 M16	150	40	25	12,5	25	0,668						
D141	●	SVVBN 3232 P16	170	40	32	40	32	1,386						



93° SVJBR

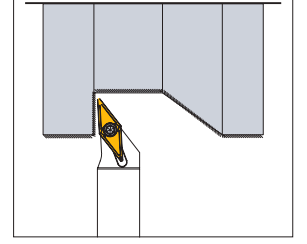
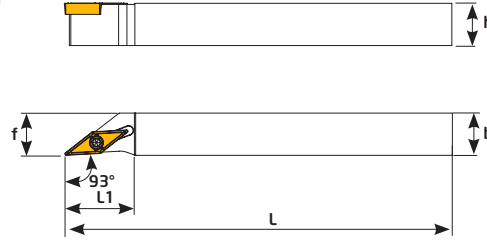

Sipariş Kodu Order Code Best.-Nr.	Stok/Stok/Lager	Ürün Kodu Product Code Produkt-Code	Ölçüler (mm) Dimensions(mm) Abmessungen (mm)						Kullanılan Uç Insert WSP	Sıkma Civatası Clamp Screw Torx-Schraube	Anahtar Torx Key Torx-Schlüssel
			L	L1	h	f	b				
D128	●	SVJBR 1010 J11-F	110	22	10	10	10	0,098	VBMT 1103	TC061 M2,5x6,5	T8
D129	●	SVJBR 1212 J11-F	110	22	12	12	12	0,132			
D130	●	SVJBR 1616 H11-F	100	25	16	16	16	0,204			

93° SVJBL

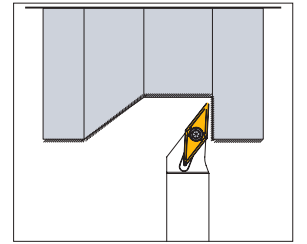
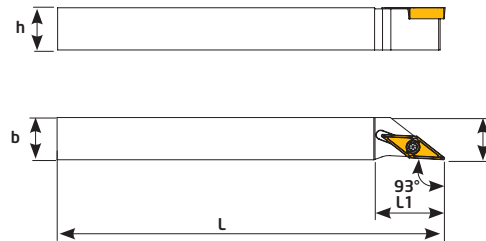

Sipariş Kodu Order Code Best.-Nr.	Stok/Stok/Lager	Ürün Kodu Product Code Produkt-Code	Ölçüler (mm) Dimensions(mm) Abmessungen (mm)						Kullanılan Uç Insert WSP	Sıkma Civatası Clamp Screw Torx-Schraube	Anahtar Torx Key Torx-Schlüssel
			L	L1	h	f	b				
D395	●	SVJBL 1010 J11-F	110	22	10	10	10	0,098	VBMT 1103	TC061 M2,5x6,5	T8
D396	●	SVJBL 1212 J11-F	110	22	12	12	12	0,132			
D397	●	SVJBL 1616 H11-F	100	25	16	16	16	0,204			

93° SVJCR

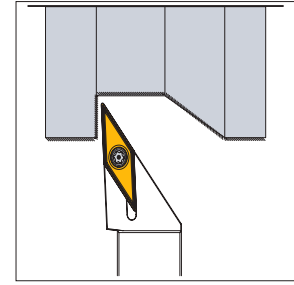
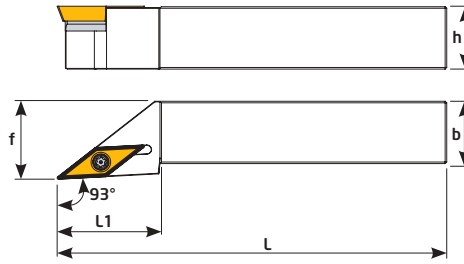

Sipariş Kodu Order Code Best.-Nr.	Stok/Stock/Lager	Ürün Kodu Product Code Produkt-Code	Ölçüler (mm) Dimensions(mm) Abmessungen (mm)							Kullanılan Uç Insert WSP	Sıkma Cıvatası Clamp Screw Torx-Schraube	Altlık im U-Platte	Altlık Cıvatası Shim Screw U-Platte Schraube	Anahtar Torx Key Torx-Schlüssel
			L	L1	h	f	b	kg						
D239	●	SVJCR 1010 J11	110	21	10	12	10	0,086	VCMT 1103	TC060 M2,5x5,5	---	---	T8	
D240	●	SVJCR 1212 J11	110	21	12	16	12	0,135						
D241	●	SVJCR 1616 H11	100	25	16	20	16	0,204						
D242	●	SVJCR 2020 K11	125	33	20	25	20	0,378						
D243	●	SVJCR 2525 M11	150	40	25	32	25	0,738	TC063 M2,5x7	TA034	TC048 M5	T15		
D244	●	SVJCR 1616 H16	100	33	16	20	16	0,195	VCMT 1604				TC068 M3,5x11	
D246	●	SVJCR 2020 K16	125	33	20	25	20	0,385						
D248	●	SVJCR 2525 M16	150	40	25	32	25	0,683						
D249	●	SVJCR 3232 P16	170	50	32	40	32	1,284						

93° SVJCL

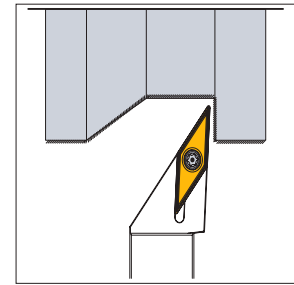
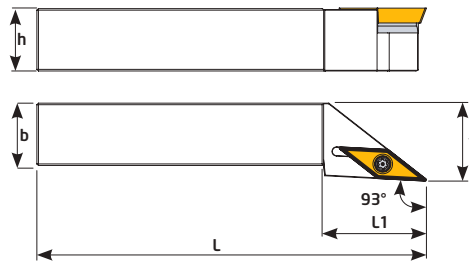

Sipariş Kodu Order Code Best.-Nr.	Stok/Stock/Lager	Ürün Kodu Product Code Produkt-Code	Ölçüler (mm) Dimensions(mm) Abmessungen (mm)							Kullanılan Uç Insert WSP	Sıkma Cıvatası Clamp Screw Torx-Schraube	Altlık Shim U-Platte	Altlık Cıvatası Shim Screw U-Platte Schraube	Anahtar Torx Key Torx-Schlüssel
			L	L1	h	f	b	kg						
D383	●	SVJCL 1010 J11	110	21	10	12	10	0,086	VCMT 1103	TC060 M2,5x5,5	---	---	T8	
D384	●	SVJCL 1212 J11	110	21	12	16	12	0,135						
D385	●	SVJCL 1616 H11	100	25	16	20	16	0,204						
D386	●	SVJCL 2020 K11	125	33	20	25	20	0,378						
D387	●	SVJCL 2525 M11	150	40	25	32	25	0,738	TC063 M2,5x7	TA034	TC048 M5	T15		
D388	●	SVJCL 1616 H16	100	33	16	20	16	0,195	VCMT 1604				TC068 M3,5x11	
D390	●	SVJCL 2020 K16	125	33	20	25	20	0,385						
D392	●	SVJCL 2525 M16	150	40	25	32	25	0,683						
D393	●	SVJCL 3232 P16	170	50	32	40	32	1,284						

90° SVJCR

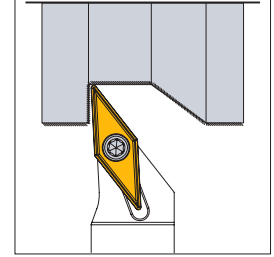
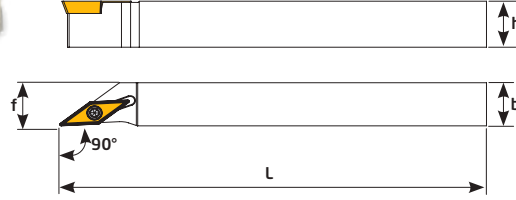

Sipariş Kodu Order Code Best.-Nr.	Stok/Stock/Lager	Ürün Kodu Product Code Produkt-Code	Ölçüler (mm) Dimensions(mm) Abmessungen (mm)					Kullanılan Uç Insert WSP	Sıkma Civatası Clamp Screw Torx-Schraube	Anahtar Torx Key Torx-Schlüssel
			L	h	f	b	kg			
D460	●	SVJCR 1212 J11-F	110	12	12	12	0,134	VCMT 1103	TC060 M2,5x5,5	T8
D462	●	SVJCR 1616 H11-F	100	16	16	16	0,202			

72,5° SVVCN

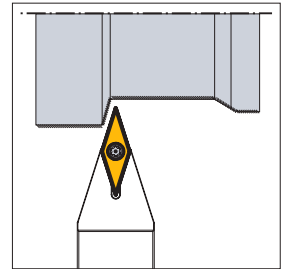
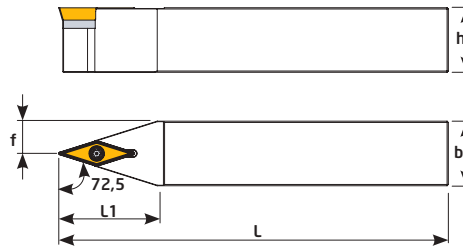

Sipariş Kodu Order Code Best.-Nr.	Stok/Stock/Lager	Ürün Kodu Product Code Produkt-Code	Ölçüler (mm) Dimensions(mm) Abmessungen (mm)					Kullanılan Uç Insert WSP	Sıkma Civatası Clamp Screw Torx-Schraube	Altlık Shim U-Platte	Altlık Ci- vatası Shim Screw U-Platte Schraube	Anahtar Torx Key Torx-Schlüssel	
			L	L1	h	f	b						kg
D142	●	SVVCN 1212 J11	110	22	12	6	12	0,127	VC--1103	TC060 M2,5x5,5	---	---	T8
D144	●	SVVCN 1616 H16	100	35	16	8	16	0,187	VCMT1604	TC068 M3,5x11	TA034	TC048 M5	T15
D150	●	SVVCN 2020 K16	125	35	20	10	20	0,373					
D152	●	SVVCN 2525 M16	150	40	25	12,5	25	0,675					

30° SRGCR

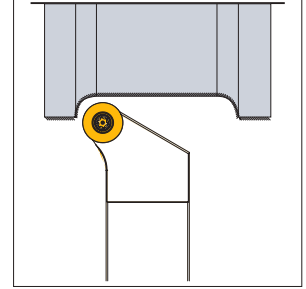
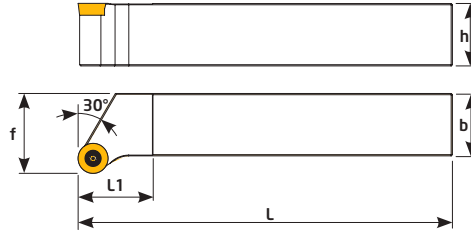

Sipariş Kodu Order Code Best.-Nr.	Stok/Stock/Lager	Ürün Kodu Product Code Produkt-Code	Ölçüler (mm) Dimensions(mm) Abmessungen (mm)						Kullanılan Uç Insert WSP	Sıkma Civatası Clamp Screw Torx-Schraube	Anahtar Torx Key Torx-Schlüssel
			L	L1	h	f	b	kg			
D280	●	SRGCR 2020 K08	125	25	20	25	20	0,411	RCMT 0803	TC065 M3x7	T8
D282	●	SRGCR 2525 M08	150	30	25	32	25	0,710			
D284	●	SRGCR 2020 K10	125	25	20	25	20	0,410	RCMT 10T3	TC067 M3,5x8,5	T15
D286	●	SRGCR 2525 M10	150	30	25	32	25	0,720			
D288	●	SRGCR 2020 K12	125	25	20	25	20	0,422	RCMT 1204	TC067 M3,5x8,5	T15
D290	●	SRGCR 2525 M12	150	30	25	32	25	0,744			

30° SRGCL

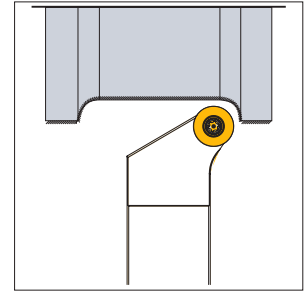
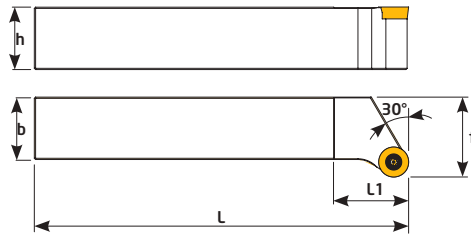

Sipariş Kodu Order Code Best.-Nr.	Stok/Stock/Lager	Ürün Kodu Product Code Produkt-Code	Ölçüler (mm) Dimensions(mm) Abmessungen (mm)						Kullanılan Uç Insert WSP	Sıkma Civatası Clamp Screw Torx-Schraube	Anahtar Torx Key Torx-Schlüssel
			L	L1	h	f	b	kg			
D293	●	SRGCL 2020 K08	125	25	20	25	20	0,411	RCMT 0803	TC065 M3x7	T8
D294	●	SRGCL 2525 M08	150	30	25	32	25	0,710			
D283	●	SRGCL 2020 K10	125	25	20	25	20	0,410	RCMT 10T3	TC067 M3,5x8,5	T15
D292	●	SRGCL 2525 M10	150	30	25	32	25	0,720			
D281	●	SRGCL 2020 K12	125	25	20	25	20	0,422	RCMT 1204	TC067 M3,5x8,5	T15
D291	●	SRGCL 2525 M12	150	30	25	32	25	0,744			