



YG *i-Xmill*

**COATED EXCHANGEABLE CARBIDE INSERTS
WITH CARBIDE & STEEL HOLDERS
FOR VARIOUS MATERIALS**

For General Purpose, Pre-Hardened Steels,
High-Hardened Steels, Stainless Steels and Graphite
High Precision Cutting and Wear Resistance

YG-1 CO., LTD.

HEAD OFFICE

211, Sewolcheon-ro, Bupyeong-gu, Incheon, South Korea

Phone: +82-32-526-0909

Http://www.yg1.kr

E-mail: yg1@yg1.kr

Note The new address above has currently been updated since Korean new postal standard was valid from 2014.
Be noticed that the physical Headquarter location is NOT changed.



Search 'YG-1' on social media outlets

YEEI181001006

FEATURES AND BENEFITS

i-Xmill BALL INSERT

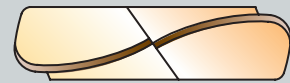

1. Helical end gash ("S" gash) geometry

- Low milling torque
- Prevents chattering
- Improves chip ejection
- Prolong tool life

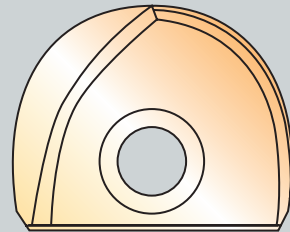

2. Polished cutting edges

- Better wear resistance and tool life
- Improves repeatability in performance
- Improves surface roughness on work-piece
- Improves coating

3. Special coating

- Combine high hardness with high thermal stability against oxidation
- Superior wear resistance
- Faster feeds and speeds

i-Xmill CORNER RADIUS INSERT



1. The optimized tool geometry achieves better reliability and reduces vibration and cutting load.

2. Corner radius insert can be used with the ball holder, but for a better precision in cutting. It is recommended to use the corner radius holder.

3. The various and wide cutting range allows machining in both roughing and finishing.

4. Special coating makes high hardness with high thermal stability against oxidation.

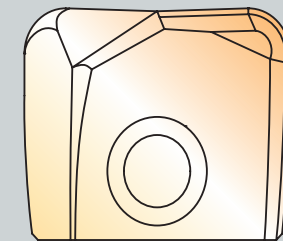

i-Xmill CARBIDE HOLDER

1. As rigid as a solid carbide end mill for stable machining with reduced vibration and enhanced finish
2. Allows a high quality of finishing even when machining the deeper part of a mold
3. Longer tool life than a steel holder
4. Shrink Fit Holding system can be applied
5. Upon request, the broken holder is able to be regenerated
6. Your carbide holder can be regenerated as YG-1 type upon request

i-Xmill STEEL HOLDER

1. Premium alloy steel with excellent strength
2. Precise shank tolerance (h6)
3. Nickel plated, to prevent corrosion and improve lubricity

CASE STUDY

▶ TEST- I for General Purpose (Corner Radius)

Tools	i-Xmill Corner Radius (XMR110A16020)
Size(mm)	Ø16 x R2.0
Work Material	- DIN: 40CrMnNiMo8-6-4 (1.2738) - AISI: P20+Ni - KS: KP4M (Mold steels HRC35)
Cutting Speed	280 m/min.
RPM	5,570 rev./min.
Feed	2,230 mm/min.
Feed per tooth	0.2 mm/tooth
Milling Method	Side Cutting
Milling Depth	Axial: 3.0 mm Radial: 0.2 mm
Coolant	Oil Mist
Overhang	70 mm
Machine	Machining Center

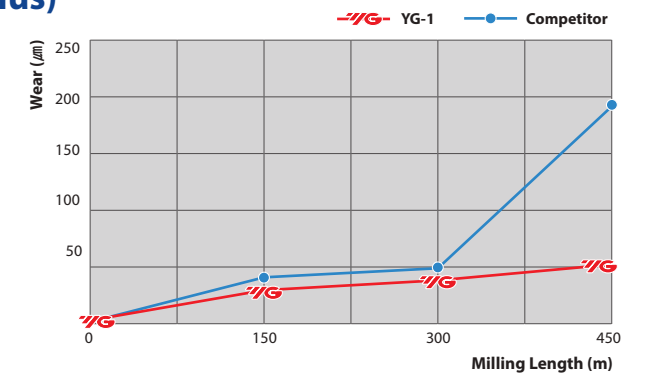

i-Xmill (Total milling length 450m)

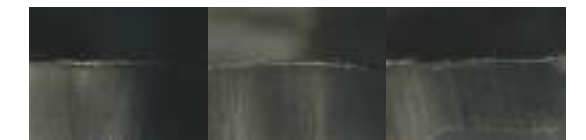

Competitor (Total milling length 450m)

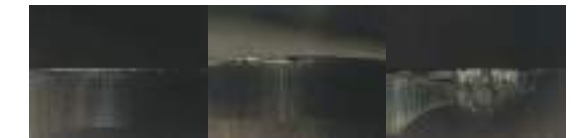

▶ TEST- II for Pre-Hardened Steels (Ball)

Tools	i-Xmill Ball (XMB120C160)
Size(mm)	Ø16 x R8.0
Work Material	- DIN : X40GrMoV51 (1.2344) - AISI : H13 - JIS: SKD61 (HRC50)
Cutting Speed	80.42 m/min.
RPM	1,600 rev./min.
Feed	390 mm/min.
Feed per tooth	0.12 mm/tooth
Milling Method	Side Cutting
Milling Depth	Axial: 0.8 mm Radial: 1.6 mm
Coolant	Oil Mist
Overhang	YG-1, Competitor B: 48 mm Competitor A: 56 mm
Machine	Machining Center

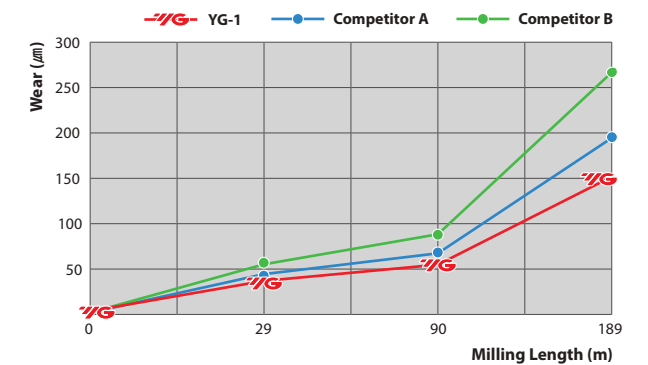

i-Xmill (Total milling length 189m)



Competitor A (Total milling length 189m)



Competitor B (Total milling length 189m)

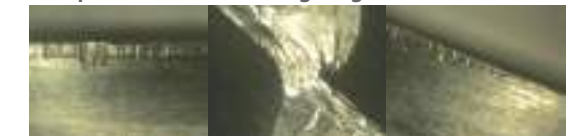

CASE STUDY

▶ TEST- III for High Hardened Steels (Ball)

Tools	i-Xmill Ball (XMB260T160)
Size(mm)	Ø16 x R8.0
Work Material	- DIN: X155CrVMo12-1 (1.2379) - AISI: D2 - JIS: SKD11 (HRC60)
Cutting Speed	70.02 m/min.
RPM	1,393 rev./min.
Feed	613 mm/min.
Feed per tooth	0.22 mm/tooth
Milling Method	Profile Cutting
Milling Depth	Axial: 0.1 mm Radial: 0.3 mm
Coolant	Oil Mist
Machine	Machining Center

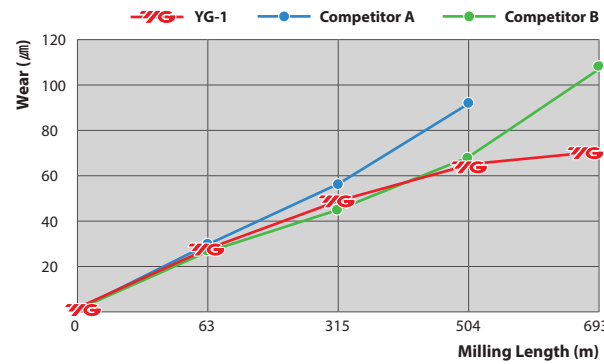

i-Xmill (Total milling length 693m)



Competitor A (Total milling length 504m)



Competitor B (Total milling length 693m)



▶ TEST-IV for High Hardened Steels (Corner Radius)

Tools	i-Xmill Corner Radius (XMR260T25010)
Size(mm)	Ø25 x R1.0
Work Material	- DIN: X155CrVMo12-1 (1.2379) - AISI: D2 - JIS: SKD11 (HRC60)
Cutting Speed	80.11 m/min.
RPM	1,020 rev./min.
Feed	310 mm/min.
Feed per tooth	0.15 mm/tooth
Milling Depth	Axial: 0.4 mm Radial: 0.2 mm
Milling Length	30 m
Milling Method	Down & Side Cutting
Coolant	Oil mist

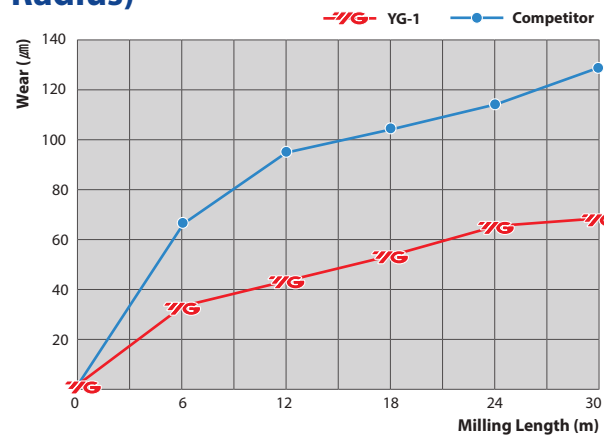

i-Xmill (Total milling length 30m)

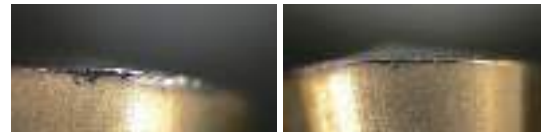

Competitor (Total milling length 30m)

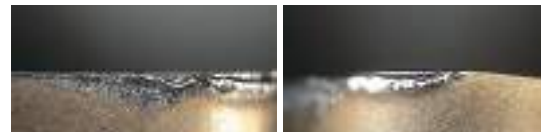

CASE STUDY

▶ TEST- V for Graphite (Corner Radius)

Tools	i-Xmill Corner Radius (XMR110D17010)
Size(mm)	Ø17 x R1.0
Work Material	Graphite
Cutting Speed	320 m/min.
RPM	6,000 rev./min.
Feed	2,800 mm/min.
Feed per tooth	0.23 mm/tooth
Milling Depth	Axial : 0.2 mm
Coolant	Air

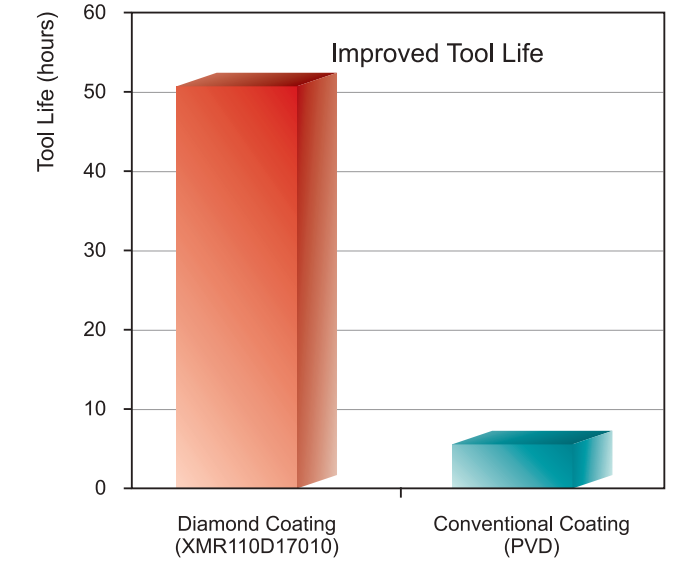

Coating properties

This coating generation features a good crystalline structure. It protects tools perfectly against abrasive wear and is unsurpassed in graphite cutting

Features

1. High Abrasive wear resistance
2. Good Coefficient of friction
3. High Precision

Benefits

i-Xmill with diamond coating shows excellent performance in graphite cutting at high speed allowing an improved surface finish

Applications

1. Precision-structured graphite electrodes
2. Ceramics (greens, sintered) Dental, Machinery

Diamond layer

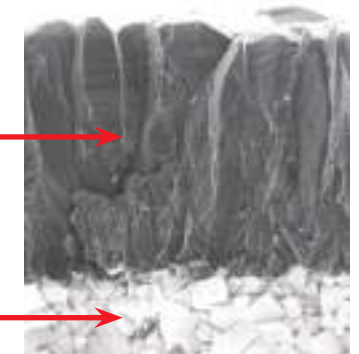

Base material

Crystalline structure

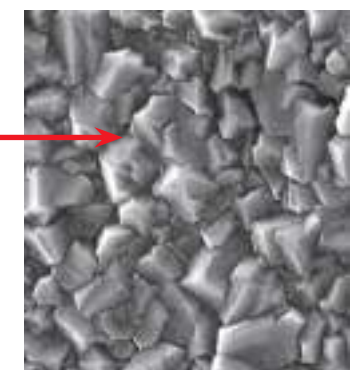

CASE STUDY

▶ TEST-VI for Stainless Steels (Ball)

Tools	i-Xmill Ball (XMB130A160)
Size(mm)	Ø16 x R8.0
Work Material	- DIN: X5CrNi1810 (X4CrNi18-10) - WR: 1.4301 - JIS: SUS304
Cutting Speed	119.9 m/min.
RPM	2,385 rev./min.
Feed	688 mm/min.
Cutting Depth	Axial: 0.3 mm Radial: 3.2 mm
Milling Length	393 m
Milling Method	Profiling Cutting
Coolant	Wet cut

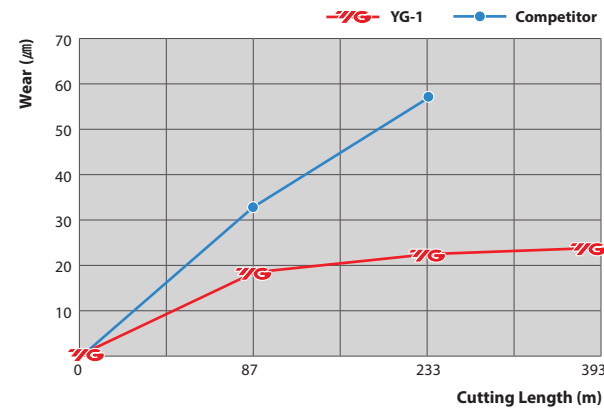

i-Xmill (Total milling length 393m)



Competitor (Total milling length 233m)



▶ TEST-VII for Stainless Steels (Corner Radius)

Tools	i-Xmill Corner Radius (XMR130A16020)
Size(mm)	Ø16 x R2.0
Work Material	- DIN: X5CrNi1810 (X4CrNi18-10) - WR: 1.4301 - JIS: SUS304
Cutting Speed	129.99 m/min.
RPM	2,586 rev./min.
Feed	647 mm/min.
Feed per tooth	0.13 mm/tooth
Milling Depth	Axial: 0.4 mm Radial: 0.4 mm
Milling Length	750 m
Milling Method	Down & Side Cutting
Coolant	Wet cut

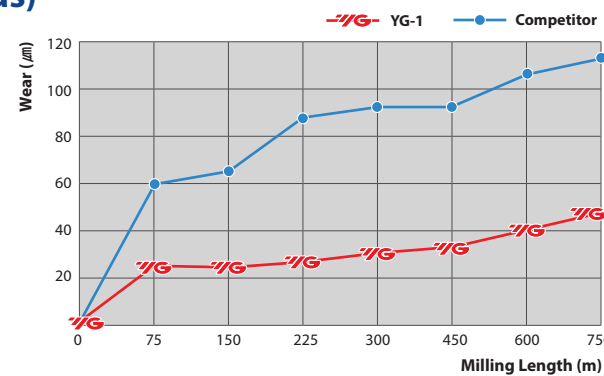

i-Xmill (Total milling length 750m)



Competitor (Total milling length 750m)



CASE STUDY

▶ TEST-VIII for General Purpose - High Feed (Corner Radius)

Tools	i-Xmill Corner Radius (XMF110V16015)
Size(mm)	Ø16 x R1.5
Work Material	- DIN: X40GrMoV51 (1.2344) - AISI: H13 - JIS: SKD61
Cutting Speed	174.97 m/min.
RPM	3,481 rev./min.
Feed	6,962 mm/min.
Feed per tooth	1.0 mm/tooth
Milling Depth	Axial: 0.6 mm Radial: 7.0 mm
Milling Length	210 m
Milling Method	Down & Side Cutting
Coolant	Oil Mist

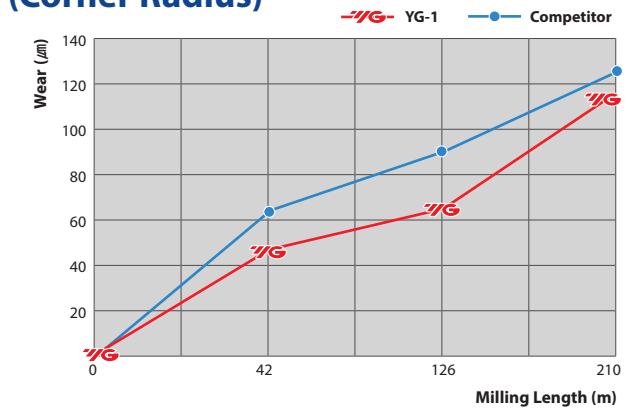

i-Xmill (Total milling length 210m)



Competitor (Total milling length 210m)



▶ TEST-IX for General Purpose - Full Radius (Ball)

Tools	i-Xmill Ball (XMM110V160)
Size(mm)	Ø16 x R8.0
Work Material	- DIN: C45 - WR: 1.0503 - JIS: S45C (HRC25)
Cutting Speed	200.0 m/min.
RPM	3,979 rev./min.
Feed	1,990 mm/min.
Feed per tooth	0.25 mm/tooth
Milling Depth	Axial: 0.5 mm Radial: 2.0 mm
Milling Length	120 m
Milling Method	Profiling Cutting
Coolant	Oil mist

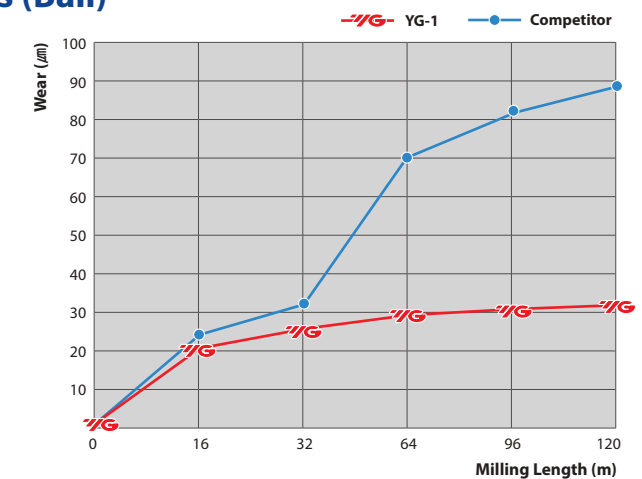

i-Xmill (Total milling length 120m)



Competitor (Total milling length 120m)



SELECTION GUIDE

i-Xmill
COATED EXCHANGEABLE CARBIDE INSERTS
WITH CARBIDE & STEEL HOLDERS

◎ : Excellent ○ : Good

ITEM	MODEL	DESCRIPTION	SIZE		PAGE
			Min.	Max.	
XMB110A		For General Purpose	Ø8.0	Ø33.0	10
XMB120C		For Pre-Hardened Steels	Ø8.0	Ø33.0	
XMB260T		For High Hardened Steels	Ø8.0	Ø33.0	
XMB130A		For Stainless Steels	Ø8.0	Ø33.0	
XMM110V		For General Purpose - Full Radius	Ø8.0	Ø33.0	
XMB110D		For Graphite	Ø8.0	Ø33.0	
XMR110A		For General Purpose & Stainless Steels	Ø8.0	Ø33.0	11 14
XMR120C		For Pre-Hardened Steels	Ø8.0	Ø33.0	
XMR260T		For High Hardened Steels	Ø8.0	Ø33.0	
XMF110V		For General Purpose - High Feed	Ø8.0	Ø33.0	
XMR110D		For Graphite	Ø8.0	Ø33.0	
ZBC		Carbide Holder - Straight Neck	Ø8.0	Ø33.0	
ZRC		Carbide Holder - Straight Neck	Ø8.0	Ø33.0	16
ZBT		Steel Holder - Taper Neck	Ø8.0	Ø33.0	17
ZBS		Steel Holder - Straight Neck	Ø12.0	Ø33.0	18
ZRT		Steel Holder - Taper Neck	Ø8.0	Ø13.0	19
ZRS		Steel Holder - Straight Neck	Ø12.0	Ø33.0	
RECOMMENDED CUTTING CONDITIONS					20

Insert

Holder

P									M	K	N	
Carbon Steels		Alloy Steels		Tool Steels		Hardened Steels		High Hardened Steels	Stainless Steels	Cast Iron	Aluminum	Graphite
~HRC35	HRC35~	~HRC35	HRC35~	~HRC35	HRC35~	HRC40~45	HRC45~55	HRC55~	~HRC28	~HRC35	~HRC8	
◎	○	◎	○	◎	○	○						
○	◎	○	◎	○	◎	◎	○	○		◎		
	○		○		○	○	◎	◎		○		
○		○		○					◎		○	
◎	○	◎	○	◎	○							
											○	◎
◎	○	◎	○	◎	○	○			◎			
○	◎	○	◎	○	◎	◎	○	○		◎		
	○		○		○	○	◎	◎		○		
◎	○	◎	○	◎	○							
											○	◎

BALL INSERTS

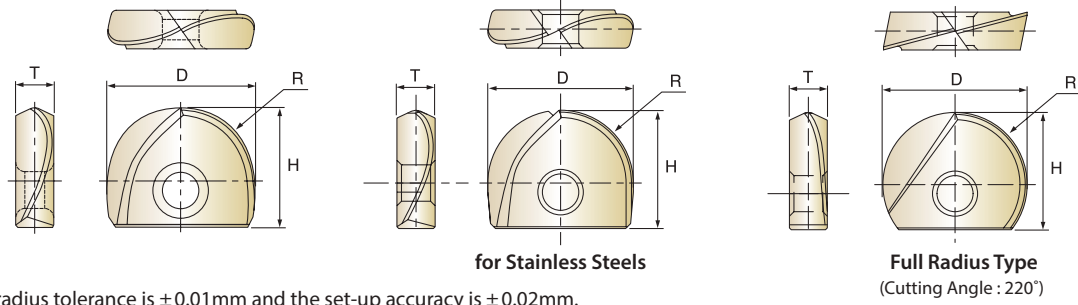

● The ball radius tolerance is $\pm 0.01\text{mm}$ and the set-up accuracy is $\pm 0.02\text{mm}$.

Ball Type	Continuous		Minor Intermittent		Heavy Intermittent	
	P	Steels	●	●	●	●
M	Stainless Steels				●	
K	Cast Iron		●			
N	Non Ferrous		●		●	●
S	Heat Resistant		●			

Unit : mm

SHAPE	SPECIFICATION	EDP NO.	GRADE						DIMENSIONS				
			PVD					Diamond	D	R	H	T	
			XMB110A	XMB120C	XMB260T	XMB130A	XMM110V	XMB110D					
	Diameter	Grade	Designation	for General Purpose	for Pre-Hardened Steels	for High Hardened Steels	for Stainless Steels	for General Purpose Full Radius Type	for Graphite				
	Ø8	XMB110A XMB120C XMB260T XMB130A XMM110V XMB110D	080	●	●	●	●	●	●	8	R4.0	8	2.4
	Ø10		100	●	●	●	●	●	●	10	R5.0	9.5	2.7
	Ø11		110	●	●	●	●	●	○	11	R5.5	10	2.7
	Ø12		120	●	●	●	●	●	●	12	R6.0	11	3.2
	Ø13		130	●	●	●	●	●	○	13	R6.5	11.5	3.2
	Ø16		160	●	●	●	●	●	●	16	R8	13	4.2
	Ø17		170	●	●	●	●	●	○	17	R8.5	13.5	4.2
	Ø20		200	●	●	●	●	●	●	20	R10	16	5.2
	Ø21		210	●	●	●	●	●	○	21	R10.5	16.5	5.2
	Ø25		250	●	●	●	●	●	●	25	R12.5	19.5	6.2
	Ø26		260	●	●	●	●	●	○	26	R13	20	6.2
	Ø30		300	●	●	●	●	●	●	30	R15	23.5	7.2
	Ø32		320	●	●	●	●	●	●	32	R16	24.5	7.2
	Ø33		330	●	●	●	●	●	○	33	R16.5	25	7.2

* EDP No. of each selected items is a combination of "Grade" and "Designation"

For example, EDP No. of Grade XMB110A, designation 080 therefore the insert EDP No. to order is: XMB110A 080

* Stock situation is subject to change without prior notice

* ●: Stock item ○: Order made item

CORNER RADIUS INSERTS

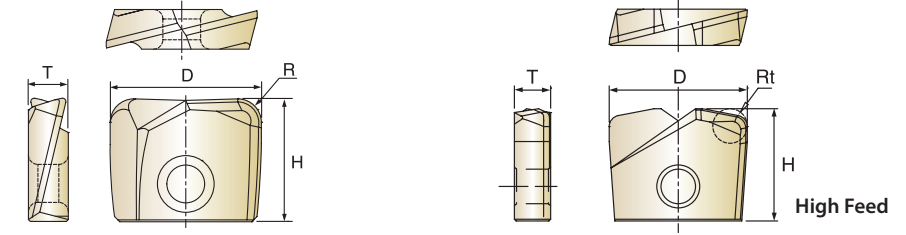

● The corner radius tolerance is $\pm 0.015\text{mm}$ and the set-up accuracy is $\pm 0.02\text{mm}$.

● Corner radius insert can be used with the ball holder, but for a better precision in cutting. It is recommended to use the corner radius holder.

Corner Radius Type	Continuous		Minor Intermittent		Heavy Intermittent	
	P	Steels	●	●	●	●
M	Stainless Steels				●	
K	Cast Iron		●			
N	Non Ferrous		●		●	●
S	Heat Resistant		●			

Unit : mm

SHAPE	SPECIFICATION	EDP NO.	GRADE					DIMENSIONS					
			PVD				Diamond	D	R (Rt)	H	T	ap Max.	
			XMR110A	XMR120C	XMR260T	XMF110V	XMR110D						
	Diameter with Corner-R	Grade	Designation	for General Purpose & Stainless Steels	for Pre-Hardened Steels	for High Hardened Steels	for General Purpose High Feed	for Graphite					
	Ø8 R0.3	XMR110A XMR120C XMR260T XMF110V XMR110D	080 03	●	●	●	-	○	8	R0.3	8	2.4	0.4
	Ø8 R0.5		080 05	●	●	●	-	○	R0.5				
	Ø8 R0.8		080 08	-	-	-	●	-	R0.8				
	Ø8 R1.0		080 10	●	●	●	-	○	R1.0				
	*Ø8 R2.0		080 20	●	●	●	-	○	R2.0				
	Ø10 R0.3		100 03	●	●	●	-	○	R0.3				
	Ø10 R0.5		100 05	●	●	●	-	○	R0.5				
	Ø10 R1.0		100 10	●	●	●	●	○	R1.0				
	Ø10 R1.5		100 15	●	●	●	-	○	R1.5				
	Ø10 R2.0		100 20	●	●	●	-	○	R2.0				
	*Ø10 R3.0		100 30	○	○	○	-	○	R3.0				
	Ø11 R0.3		110 03	●	●	●	-	○	R0.3				
	Ø11 R0.5		110 05	●	●	●	-	○	R0.5				
	Ø11 R1.0		110 10	●	●	●	●	○	R1.0				
	Ø11 R1.5		110 15	●	●	●	-	○	R1.5				
	Ø11 R2.0		110 20	●	●	●	-	○	R2.0				
	*Ø11 R3.0		110 30	○	○	○	-	○	R3.0				
	Ø12 R0.3		120 03	●	●	●	-	○	R0.3				
	Ø12 R0.5		120 05	●	●	●	-	○	R0.5				
	Ø12 R1.0		120 10	●	●	●	●	○	R1.0				
	Ø12 R1.5		120 15	●	●	●	-	○	R1.5				
	Ø12 R2.0		120 20	●	●	●	-	○	R2.0				
	Ø12 R3.0		120 30	●	●	●	-	○	R3.0				
	Ø13 R0.3		130 03	●	●	●	-	○	R0.3				
	Ø13 R0.5		130 05	●	●	●	-	○	R0.5				
	Ø13 R1.0		130 10	●	●	●	●	○	R1.0				
	Ø13 R1.5		130 15	●	●	●	-	○	R1.5				
	Ø13 R2.0		130 20	●	●	●	-	○	R2.0				
	Ø13 R3.0		130 30	○	○	○	-	○	R3.0				

* Recommend to use in Ball Type Holder due to large R value

CORNER RADIUS INSERTS

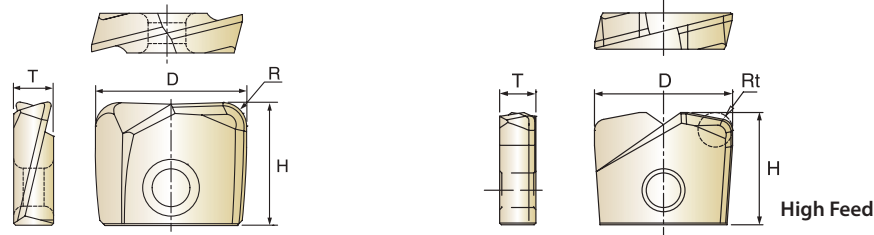

- The corner radius tolerance is $\pm 0.015\text{mm}$ and the set-up accuracy is $\pm 0.02\text{mm}$.
- Corner radius insert can be used with the ball holder, but for a better precision in cutting. It is recommended to use the corner radius holder.

Corner Radius Type	Continuous		Minor Intermittent		Heavy Intermittent	
	P	Steels	●	●	●	●
M	Stainless Steels	●				
K	Cast Iron		●			
N	Non Ferrous	●		●		●
S	Heat Resistant		●			

Unit : mm

SHAPE	SPECIFICATION	EDP NO.		GRADE					DIMENSIONS					
				PVD				Diamond	D	R (Rt)	H	T	ap Max.	High Feed
				XMR110A	XMR120C	XMR260T	XMF110V							
	Ø16 R0.3	XMR110A XMR120C XMR260T XMF110V XMR110D	160 03	●	●	●	-	○	16	R0.3	13	4.2	0.8	
	Ø16 R0.5		160 05	●	●	●	-	○		R0.5				
	Ø16 R1.0		160 10	●	●	●	-	○		R1.0				
	Ø16 R1.5		160 15	●	●	●	●	○		R1.5				
	Ø16 R2.0		160 20	●	●	●	-	○		R2.0				
	Ø16 R3.0		160 30	●	●	●	-	○		R3.0				
	Ø17 R0.3		170 03	●	●	●	-	○	17	R0.3	13	4.2	0.8	
	Ø17 R0.5		170 05	●	●	●	-	○		R0.5				
	Ø17 R1.0		170 10	●	●	●	-	○		R1.0				
	Ø17 R1.5		170 15	●	●	●	●	○	R1.5					
	Ø17 R2.0		170 20	●	●	●	-	○	R2.0					
	Ø17 R3.0		170 30	●	●	●	-	○	R3.0					
	Ø20 R0.3		200 03	●	●	●	-	○	20	R0.3	16	5.2	1.0	
	Ø20 R0.5		200 05	●	●	●	-	○		R0.5				
	Ø20 R1.0		200 10	●	●	●	-	○		R1.0				
	Ø20 R1.5		200 15	●	●	●	-	○		R1.5				
	Ø20 R2.0		200 20	●	●	●	●	○		R2.0				
	Ø20 R3.0		200 30	●	●	●	-	○		R3.0				
	Ø21 R0.3		210 03	●	●	●	-	○	21	R0.3	16	5.2	1.0	
	Ø21 R0.5		210 05	●	●	●	-	○		R0.5				
	Ø21 R1.0	210 10	●	●	●	-	○	R1.0						
	Ø21 R1.5	210 15	●	●	●	-	○	R1.5						
	Ø21 R2.0	210 20	●	●	●	●	○	R2.0						
	Ø21 R3.0	210 30	●	●	●	-	○	R3.0						

CORNER RADIUS INSERTS

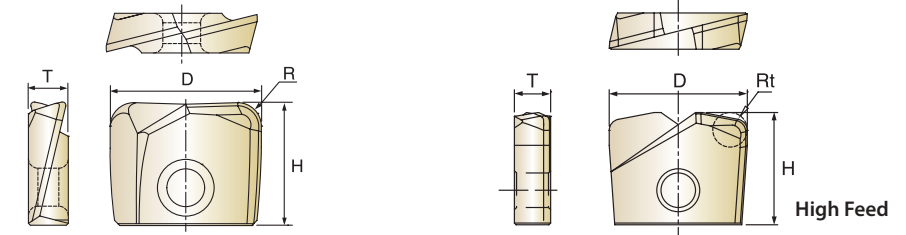

- The corner radius tolerance is $\pm 0.015\text{mm}$ and the set-up accuracy is $\pm 0.02\text{mm}$.
- Corner radius insert can be used with the ball holder, but for a better precision in cutting. It is recommended to use the corner radius holder.

Corner Radius Type	Continuous		Minor Intermittent		Heavy Intermittent	
	P	Steels	●	●	●	●
M	Stainless Steels	●				
K	Cast Iron		●			
N	Non Ferrous	●		●		●
S	Heat Resistant		●			

Unit : mm

SHAPE	SPECIFICATION	EDP NO.		GRADE					DIMENSIONS					
				PVD				Diamond	D	R (Rt)	H	T	ap Max.	High Feed
				XMR110A	XMR120C	XMR260T	XMF110V							
	Ø25 R0.3	XMR110A XMR120C XMR260T XMF110V XMR110D	250 03	●	●	●	-	○	25	R0.3	19.5	6.2	1.25	
	Ø25 R0.5		250 05	●	●	●	-	○		R0.5				
	Ø25 R1.0		250 10	●	●	●	-	○		R1.0				
	Ø25 R1.5		250 15	●	●	●	-	○		R1.5				
	Ø25 R2.0		250 20	●	●	●	-	○		R2.0				
	Ø25 R2.5		250 25	-	-	-	●	-		R2.5				
	Ø25 R3.0		250 30	●	●	●	-	○	R3.0					
	Ø26 R0.3		260 03	●	●	●	-	○	26	R0.3	19.5	6.2	1.25	
	Ø26 R0.5		260 05	●	●	●	-	○		R0.5				
	Ø26 R1.0		260 10	●	●	●	-	○		R1.0				
	Ø26 R1.5		260 15	●	●	●	-	○		R1.5				
	Ø26 R2.0		260 20	●	●	●	-	○		R2.0				
	Ø26 R2.5		260 25	-	-	-	●	-		R2.5				
	Ø26 R3.0		260 30	●	●	●	-	○	R3.0					
	Ø30 R0.3		300 03	●	●	●	-	○	30	R0.3	23.5	7.2	1.6	
	Ø30 R0.5		300 05	●	●	●	-	○		R0.5				
	Ø30 R1.0		300 10	●	●	●	-	○		R1.0				
	Ø30 R1.5		300 15	●	●	●	-	○		R1.5				
	Ø30 R2.0		300 20	●	●	●	-	○		R2.0				
	Ø30 R3.0		300 30	●	●	●	●	○		R3.0				

CORNER RADIUS INSERTS

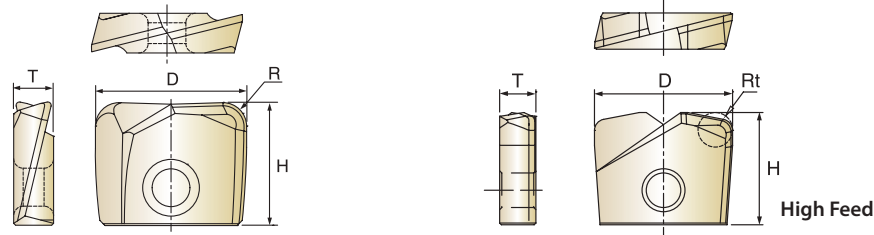

- The corner radius tolerance is $\pm 0.015\text{mm}$ and the set-up accuracy is $\pm 0.02\text{mm}$.
- Corner radius insert can be used with the ball holder, but for a better precision in cutting. It is recommended to use the corner radius holder.

Corner Radius Type	Continuous			Minor Intermittent			Heavy Intermittent		
	P	●	●	●	●	●	●	●	●
M	●	●	●	●	●	●	●	●	●
K	●	●	●	●	●	●	●	●	●
N	●	●	●	●	●	●	●	●	●
S	●	●	●	●	●	●	●	●	●

Unit : mm

SHAPE	SPECIFICATION	EDP NO.	GRADE					DIMENSIONS					
			PVD			Diamond		D	R (Rt)	H	T	ap Max.	High Feed
			XMR110A	XMR120C	XMR260T	XMF110V	XMR110D						
	Ø32 R0.3	XMR110A XMR120C XMR260T XMF110V XMR110D	320 03	●	●	●	-	○	32	R0.3	23.5	7.2	1.6
	Ø32 R0.5		320 05	●	●	●	-	○		R0.5			
	Ø32 R1.0		320 10	●	●	●	-	○		R1.0			
	Ø32 R1.5		320 15	●	●	●	-	○		R1.5			
	Ø32 R2.0		320 20	●	●	●	-	○		R2.0			
	Ø32 R3.0		320 30	●	●	●	-	○		R3.0			
	Ø32 R3.2		320 32	-	-	-	●	-	R3.2				
	Ø33 R0.3		330 03	●	●	●	-	○	33	R0.3	23.5	7.2	1.6
	Ø33 R0.5		330 05	●	●	●	-	○		R0.5			
	Ø33 R1.0		330 10	●	●	●	-	○		R1.0			
	Ø33 R1.5		330 15	●	●	●	-	○		R1.5			
	Ø33 R2.0		330 20	●	●	●	-	○		R2.0			
	Ø33 R3.0		330 30	●	●	●	-	○		R3.0			
	Ø33 R3.2		330 32	-	-	-	●	-	R3.2				

- * EDP No. of each selected items is a combination of "Grade" and "Designation"
- For example, EDP No. of Grade XMB110A, designation 080 therefore the insert EDP No. to order is: XMB110A 080
- * Stock situation is subject to change without prior notice
- * ●: Stock item ○: Order made item

CARBIDE BALL HOLDER

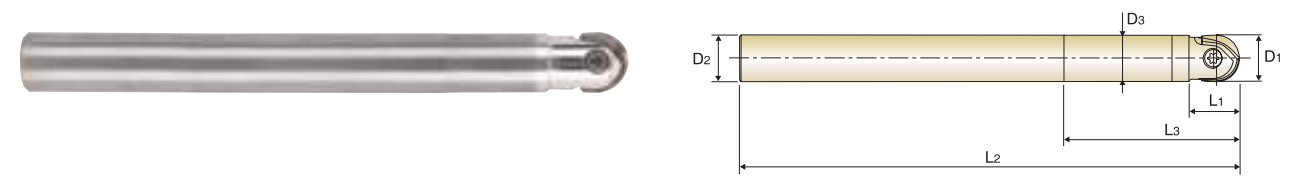

STRAIGHT NECK

Unit : mm

EDP No.	Stock	Mill Diameter	Shank Diameter	Neck Diameter	Length of Cut	Length Below Shank	Overall Length	Length Type	Wrench No.	Screw No.	
		D1	D2	D3	L1	L3	L2				
ZBC0801080	●	8	8	7.6	12	25	130	Regular	TWFT07	TX2508T07	
ZBC0802080	●					40					
ZBC0803080	●					65					
ZBC0804080	○					60	150				
ZBC0805080	○					60	200				
ZBC0806080	○					25	80	Short			
ZBC1001100	●	10, 11	10	9.5	15	30	140	Regular	TWFT08	TX3010T08	
ZBC1002100	●					50					
ZBC1003100	●					75					
ZBC1004100	○					60	180				
ZBC1005100	○					60	200				
ZBC1006100	○					30	80	Short			
ZBC120001P	○	12, 13	12	11.4	17	40	200	Long	TWFT10	TX3512T10	
ZBC1201120	●					35					
ZBC1202120	●					60					150
ZBC1203120	●					85					
ZBC1204120	○					60	250				
ZBC1205120	○					35	100	Short			
ZBC160001P	○	16, 17	16	15.0	20	50	150	Regular	TWFT15	TX4016T15	
ZBC1601160	●					50					
ZBC1602160	●					80					200
ZBC1603160	●					120					
ZBC1604160	●					80	250				
ZBC1605160	○					50	120	Short			
ZBC200002P	○	20, 21	20	19.0	25	60	150	Regular	TWBT20	TX5020T20	
ZBC2001200	●					60					
ZBC2002200	●					80					200
ZBC2003200	●					100	250				
ZBC2004200	●					150	300				
ZBC2005200	○					100	300				
ZBC250001P	○	25, 26	25	24.0	30	75	150	Regular	TWBT25	TX6025T25	
ZBC2501250	●					75					200
ZBC2502250	●					120					250
ZBC2503250	●					190	300				
ZBC2504250	○					120	350				
ZBC2505250	○					60	300				
ZBC3001320	●	30, 32, 33	32	29.0	40	90	250	Regular	TWBT30	TX8030T30	
ZBC3002320	●					150					
ZBC3003320	●					190					300
ZBC3004320	○					120	350				
ZBC3005320	○					150	400				

- * Stock situation is subject to change without prior notice
- * ●: Stock item ○: Order made item
- * ▲ Required to use T-HANDLE (TWH600)
- * Upon request, the broken holder is able to be regenerated
- * Your carbide holder can be regenerated as YG-1 type upon request

CARBIDE CORNER RADIUS HOLDER



STRAIGHT NECK

Unit : mm

EDP No.	Stock	Mill Diameter	Shank Diameter	Neck Diameter	Length of Cut	Length Below Shank	Overall Length	Length Type	Wrench No.	Screw No.
		D1	D2	D3	L1	L3	L2			
ZRC0801080	●	8	8	7.7	12	25	130	Regular	TWFT07	TX2507T07
ZRC0802080	●					40				
ZRC0803080	●					65				
ZRC1001100	●	10.0	10	9.7	15	30	140	Regular	TWFT08	TX3010T08
ZRC1002100	●					50				
ZRC1003100	●					75				
ZRC1201120	●	12, 13	12	11.7	17	35	150	Regular	TWFT10	TX3512T10
ZRC1202120	●					60				
ZRC1203120	●					85				
ZRC1601160	●	16, 17	16	15.7	20	50	200	Long	TWFT15	TX4016T15
ZRC1602160	●					80				
ZRC1603160	●					120				
ZRC1604160	●	20, 21	20	19.7	25	80	250	Regular	▲TWBT20	TX5020T20
ZRC2001200	●					60				
ZRC2002200	●					80				
ZRC2003200	●	25, 26	25	24.7	30	100	300	Long	▲TWBT25	TX6025T25
ZRC2004200	●					150				
ZRC2501250	●					75				
ZRC2502250	●	30, 32, 33	32	29.7	40	120	300	Regular	▲TWBT30	TX8030T30
ZRC2503250	●					190				
ZRC3001320	●					90				
ZRC3002320	●	30, 32, 33	32	29.7	40	150	300	Long	▲TWBT30	TX8030T30
ZRC3003320	●					190				

* Stock situation is subject to change without prior notice
 * Your carbide holder can be regenerated as YG-1 type upon request
 * ●: Stock item ○: Order made item
 * ▲ Required to use T-HANDLE (TWH600)

STEEL BALL HOLDER



TAPER NECK

Unit : mm

EDP No.	Stock	Mill Diameter	Shank Diameter	Neck Diameter	Length of Cut	Length Below Shank	Overall Length	Interference Angle	Length Type	Wrench No.	Screw No.
		D1	D2	D3	L1	L3	L2	θ°			
ZBT0801120	●	8	12	7.2	12	35	90	4° 43'	Short	TWFT07	TX2508T07
ZBT0802120	●				25	55	110	3° 37'	Regular		
ZBT1001120	●	10, 11	12	9	15	35	90	2° 51'	Short	TWFT08	TX3010T08
ZBT1002120	●				30	55	110	2° 17'	Regular		
ZBT1201160	●	12, 13	16	10.5	17	55	110	3° 23'	Short	TWFT10	TX3512T10
ZBT1601200	●	16, 17	20	14.5	20	65	125	2° 51'	Short	TWFT15	TX4016T15
ZBT1604200	○					115	200	1° 22'	Regular		
ZBT2001250	●	20, 21	25	18	25	75	145	3° 26'	Short	▲TWBT20	TX5020T20
ZBT2004250	○					115	200	1° 55'	Regular		
ZBT2005250	○					160	250	1° 17'	Long		
ZBT2501320	●	25, 26	32	22.5	30	90	170	4° 03'	Short	▲TWBT25	TX6025T25
ZBT2504320	○					160	250	1° 53'	Regular		
ZBT2505320	○					190	300	1° 32'	Long		
ZBT3001320	●	30, 32, 33	32	27	40	110	195	1° 38'	Short	▲TWBT30	TX8030T30
ZBT3004320	○					160	250	0° 58'	Regular		
ZBT3005320	○					190	300	0° 46'	Long		

* Stock situation is subject to change without prior notice
 * ●: Stock item ○: Order made item
 * ▲ Required to use T-HANDLE (TWH600)

STEEL BALL HOLDER

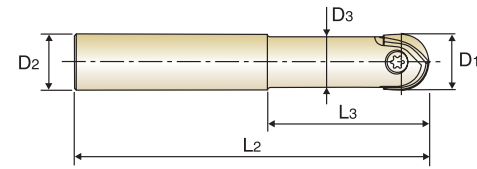

STRAIGHT NECK

Unit : mm

EDP No.	Stock	Mill Diameter	Shank Diameter	Neck Diameter	Length Below Shank	Overall Length	Length Type	Wrench No.	Screw No.
		D1	D2	D3	L3	L2			
ZBS1201120	●	12, 13	12	10.5	35	90	Short	TWFT10	TX3512T10
ZBS1202120	●				55	110	Regular		
ZBS120001P	○				40	150	Long		
ZBS1601160	●	16, 17	16	14.5	35	95	Short	TWFT15	TX4016T15
ZBS1602160	●				65	125	Regular		
ZBS160001P	○				60	200	Long		
ZBS2001200	●	20, 21	20	18	40	110	Short	▲TWBT20	TX5020T20
ZBS2002200	●				75	145	Regular		
ZBS200001P	○				80	200	Long		
ZBS200002P	○				60	200	Long		
ZBS2501250	●	25, 26	25	22.5	45	125	Short	▲TWBT25	TX6025T25
ZBS2502250	●				90	170	Regular		
ZBS2503250	○				100	250	Long		
ZBS250001P	○				90	200	Long		
ZBS250002P	○				60	200	Long		
ZBS3001320	●	30, 32, 33	32	27	55	140	Short	▲TWBT30	TX8030T30
ZBS3002320	●				110	195	Regular		
ZBS3004320	○				150	350	Long		
ZBS300001P	○				100	250	Long		

* Stock situation is subject to change without prior notice

* ●: Stock item ○: Order made item

* ▲ Required to use T-HANDLE (TWH600)

STEEL CORNER RADIUS HOLDER

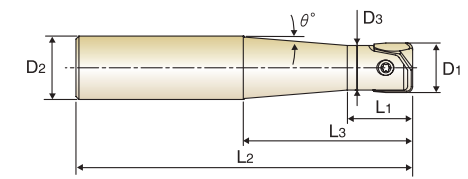

TAPER NECK

Unit : mm

EDP No.	Stock	Mill Diameter	Shank Diameter	Neck Diameter	Length of Cut	Length Below Shank	Overall Length	Interference Angle	Length Type	Wrench No.	Screw No.
		D1	D2	D3	L1	L3	L2	θ°			
ZRT0801120	●	8	12	6.7	10.0	22	100	9°	Regular	TWFT07	TX2508T07
ZRT0802120	●					50	130	2° 43'	Long		
ZRT1001120	●	10, 11	12	8.6	13.0	25	100	4° 45'	Regular	TWFT08	TX3010T08
ZRT1002120	●					50	150	1° 32'	Long		
ZRT1202160	●	12, 13	16	10.2	15.0	60	160	2° 32'	Long	TWFT10	TX3512T10

* Stock situation is subject to change without prior notice

* ●: Stock item ○: Order made item

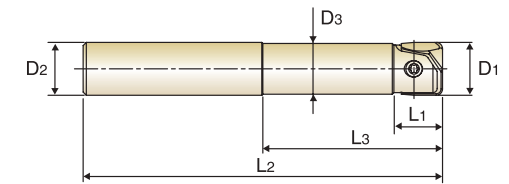

STRAIGHT NECK

Unit : mm

EDP No.	Stock	Mill Diameter	Shank Diameter	Neck Diameter	Length of Cut	Length Below Shank	Overall Length	Length Type	Wrench No.	Screw No.
		D1	D2	D3	L1	L3	L2			
ZRS1201120	●	12, 13	12	11	13	30	110	Regular	TWFT10	TX3512T10
ZRS1601160	●					50	130	Regular		
ZRS1602160	●	16, 17	16	15	15	65	165	Intermediate	TWFT15	TX4016T15
ZRS1603160	○					65	200	Long		
ZRS2001200	●	20, 21	20	19	18	60	140	Regular	▲TWBT20	TX5020T20
ZRS2002200	●					80	180	Intermediate		
ZRS2003200	○					80	250	Long		
ZRS2501250	●	25, 26	25	24	23	70	150	Regular	▲TWBT25	TX6025T25
ZRS2502250	●					90	200	Intermediate		
ZRS2503250	○					90	300	Long		
ZRS3001320	●	30, 32, 33	32	29	27	80	160	Regular	▲TWBT30	TX8030T30
ZRS3002320	●					100	220	Intermediate		
ZRS3003320	○					100	350	Long		

* Stock situation is subject to change without prior notice

* ●: Stock item ○: Order made item

* ▲ Required to use T-HANDLE (TWH600)

TECHNICAL GUIDE

ASSEMBLY OF *i-Xmill*



▲ Make sure to clean the insert and insert seat

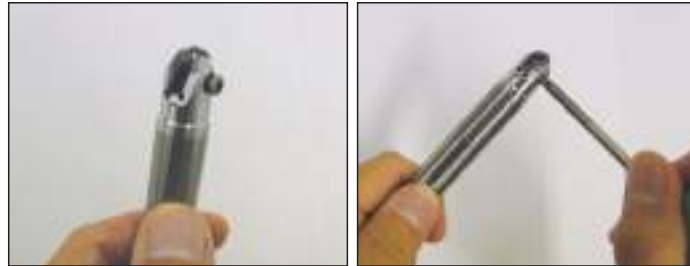

▲ Slide the insert into the slot of the holder
Tighten the screw using anti-seize compound

Size [ØD]	Clamping Torque [N·m]
Ø8	1.0
Ø10, Ø11	1.5
Ø12, Ø13	2.5
Ø16, Ø17	3.5
Ø20, Ø21	5.0
Ø25, Ø26	6.0
Ø30, Ø32, Ø33	6.5

- * When the screw is worn out, please replace it with a new one
- * Please tighten up the screw with recommended torque (Please refer to the table)
- * Don't press down the insert when the screw is tightened



CUTTING CONDITIONS

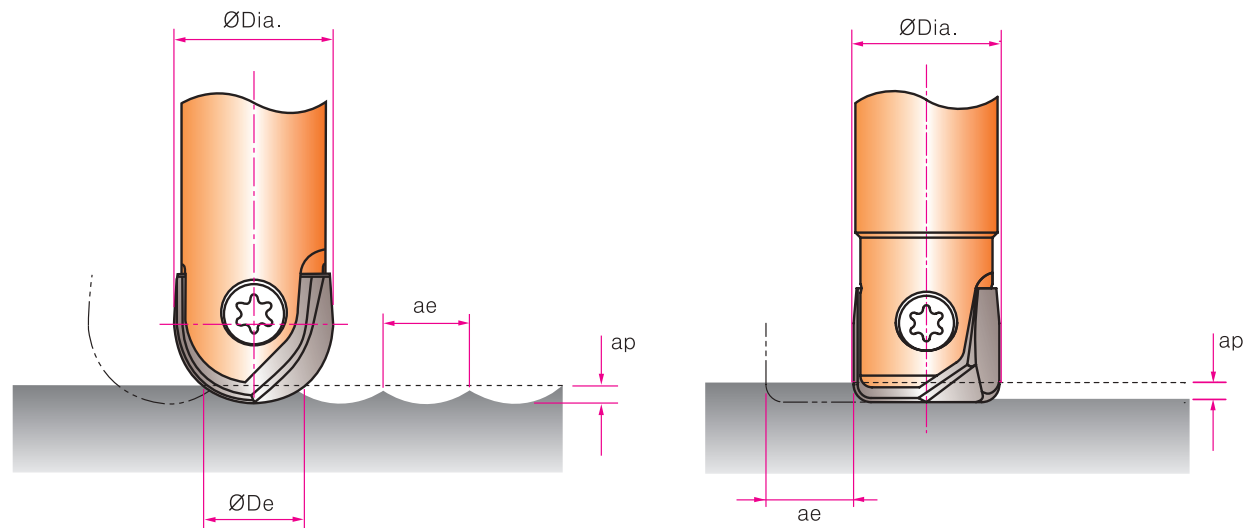

- RPM = revolution per minute (rev./min.)
- Vc = surface meter per minute (M/min.)
- Dia. = diameter of insert (mm)
- Vf = feed speed (mm/min.)
- f = feed per revolution (mm/rev.)
- De = effective tool diameter (mm)
- ap = axial depth of cut (mm)
- ae = radial depth of cut (mm)

$$Vc [M/min.] = \frac{(RPM) \cdot (\pi) \cdot (Dia.)}{1000}$$

$$Vf [mm/min.] = (RPM) \cdot (f)$$

$$RPM [rev./min.] = \frac{(Vc) \cdot (1000)}{(\pi) \cdot (Dia.)}$$

$$De [mm] = 2 \sqrt{(ap) \cdot (Dia. - ap)}$$

BALL CUTTING CONDITIONS

RPM = rev./min. Vc = m/min.
FEED = mm/min. Fz = mm/tooth

WORK MATERIALS	P								
	NON-ALLOYED STEELS ALLOY STEELS				FULL RADIUS	NON-ALLOYED STEELS ALLOY STEELS			
HARDNESS	HB	~280				~280			
	HRc	~30				~30			
STRENGTH	N/mm ²	~1000				~1000			
<i>i-Xmill</i> Type		XMB110A				XMM110V			
Cutting Conditions Roughing~Finishing		RPM	FEED	Vc	Fz	RPM	FEED	Vc	Fz
8		6370~12730	2550~5090	160~320	0.20~0.20	6370~12730	2550~5090	160~320	0.20~0.20
10, 11		5090~11460	2040~4580	160~360	0.20~0.20	5090~11460	2040~4580	160~360	0.20~0.20
12, 13		4240~10080	1700~4030	160~380	0.20~0.20	4240~10080	1700~4030	160~380	0.20~0.20
16, 17		3180~9550	1590~5730	160~480	0.25~0.30	3180~9550	1590~5730	160~480	0.25~0.30
20, 21		2550~9230	1270~7380	160~580	0.25~0.40	2550~9230	1270~7380	160~580	0.25~0.40
25, 26		2040~7640	1020~7640	160~600	0.25~0.50	2040~7640	1020~7640	160~600	0.25~0.50
30, 32, 33		1700~7430	850~8910	160~700	0.25~0.60	1700~7430	850~8910	160~700	0.25~0.60

WORK MATERIALS	P								
	ALLOY STEELS HEAT RESISTANT STEELS				DIE TOOL STEELS PRE-HARDENED				
HARDNESS	HB	280~380				380~480			
	HRc	30~40				40~50			
STRENGTH	N/mm ²	1000~1250				1250~1500			
<i>i-Xmill</i> Type		XMB110A				XMB110A, XMB120C			
Cutting Conditions Roughing~Finishing		RPM	FEED	Vc	Fz	RPM	FEED	Vc	Fz
8		4770~11140	1910~4460	120~280	0.20~0.20	3980~8750	1190~3500	100~220	0.15~0.20
10, 11		3820~9550	1530~3820	120~300	0.20~0.20	3180~8280	950~3310	100~260	0.15~0.20
12, 13		3180~9280	1270~3710	120~350	0.20~0.20	2650~7430	800~2970	100~280	0.15~0.20
16, 17		2390~7560	1190~4540	120~380	0.25~0.30	1990~6960	800~4180	100~350	0.20~0.30
20, 21		1910~6680	950~5350	120~420	0.25~0.40	1590~6370	640~5090	100~400	0.20~0.40
25, 26		1530~6110	760~6110	120~480	0.25~0.50	1270~5730	510~5730	100~450	0.20~0.50
30, 32, 33		1270~5840	640~7000	120~550	0.25~0.60	1060~5310	420~6370	100~500	0.20~0.60

WORK MATERIALS	P								
	HARDENED STEELS				HIGH HARDENED STEELS				
HARDNESS	HB	420~550				550~740			
	HRc	45~55				55~65			
STRENGTH	N/mm ²	1500~				1500~			
<i>i-Xmill</i> Type		XMB120C				XMB260T			
Cutting Conditions Roughing~Finishing		RPM	FEED	Vc	Fz	RPM	FEED	Vc	Fz
8		3180~7160	640~2860	80~180	0.10~0.20	3180~7160	640~2150	80~180	0.10~0.15
10, 11		2550~6370	510~2550	80~200	0.10~0.20	2550~6370	510~1910	80~200	0.10~0.15
12, 13		2120~5840	420~2330	80~220	0.10~0.20	2120~5840	420~1750	80~220	0.10~0.15
16, 17		1590~5170	480~3100	80~260	0.15~0.30	1590~5170	480~2590	80~260	0.15~0.25
20, 21		1270~5090	380~4070	80~320	0.15~0.40	1270~5090	380~2550	80~320	0.15~0.25
25, 26		1020~4580	310~4580	80~360	0.15~0.50	1020~4580	310~2290	80~360	0.15~0.25
30, 32, 33		850~4240	250~5090	80~400	0.15~0.60	850~4240	250~2550	80~400	0.15~0.30

BALL CUTTING CONDITIONS

RPM = rev./min. Vc = m/min.
FEED = mm/min. Fz = mm/tooth

WORK MATERIALS	M				N			
	STAINLESS STEELS				GRAPHITE			
<i>i-Xmill</i> Type	XMB130A				XMB110D			
Cutting Conditions Roughing~Finishing	RPM	FEED	Vc	Fz	RPM	FEED	Vc	Fz
8	3580~5170	720~1290	90~130	0.10~0.12	11940~15920	4770~6370	300~400	0.20~0.20
10, 11	2860~4140	720~1240	90~130	0.13~0.15	9550~12730	3820~5090	300~400	0.20~0.20
12, 13	2390~3450	720~1380	90~130	0.15~0.20	7960~10610	3180~4240	300~400	0.20~0.20
16, 17	1790~2590	540~1030	90~130	0.15~0.20	5970~7960	2980~4770	300~400	0.25~0.30
20, 21	1430~2070	430~830	90~130	0.15~0.20	4770~7640	2860~5350	300~480	0.30~0.35
25, 26	1150~1660	460~830	90~130	0.20~0.25	3820~7130	2670~5700	300~560	0.35~0.40
30, 32, 33	950~1380	380~690	90~130	0.20~0.25	3180~6900	2550~6900	300~650	0.40~0.50

WORK MATERIALS	K			
	CAST IRON			
<i>i-Xmill</i> Type	XMB120C			
Cutting Conditions Roughing~Finishing	RPM	FEED	Vc	Fz
8	6370~12730	3820~5090	160~320	0.30~0.20
10, 11	5090~11460	3060~6880	160~360	0.30~0.30
12, 13	4240~10610	2550~6370	160~400	0.30~0.30
16, 17	3180~9950	2230~5970	160~500	0.35~0.30
20, 21	2550~8750	1780~7000	160~550	0.35~0.40
25, 26	2040~7890	1430~7890	160~620	0.35~0.50
30, 32, 33	1700~7640	1190~9170	160~720	0.35~0.60

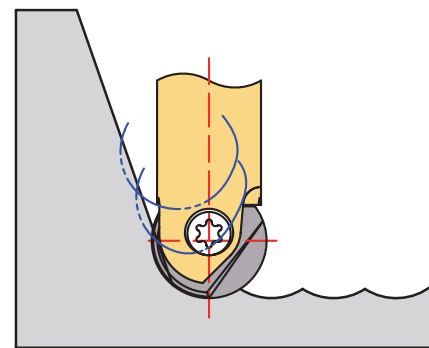

Full Radius Type

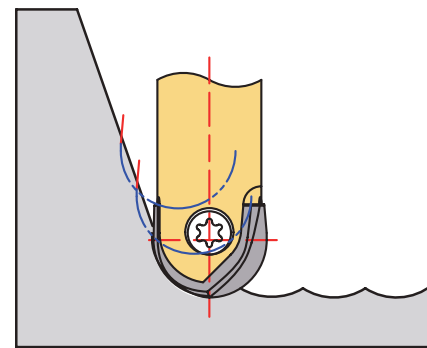

Ball Radius Type

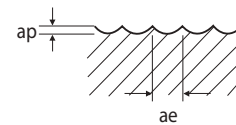

ae: Roughing - 0.1 x D
Finishing - Under Ø12 : 0.25mm
Under Ø20 : 0.30mm
From Ø20 : 0.40mm

ap: Roughing - Under Ø16 : 0.025 x D
From Ø16 : 0.05 x D
Finishing - Under Ø16 : 0.1mm

- ▶ When the length of overhang exceed 4xD, we recommend to use carbide shank holder. (Feed 20% down)
- ▶ Recommend to reduce the feed rate to 70~85% when you use long(long & intermediate Type Holder) tools.

CORNER RADIUS CUTTING CONDITIONS

RPM = rev./min. Vc = m/min.
FEED = mm/min. Fz = mm/tooth

WORK MATERIALS	P								
	NON-ALLOYED STEELS ALLOY STEELS					HIGH FEED NON-ALLOYED STEELS ALLOY STEELS			
HARDNESS	HB	~280				~280			
	HRc	~30				~30			
STRENGTH	N/mm ²	~1000				~1000			
<i>i-Xmill</i> Type	XMR110A					XMF110V			
Cutting Conditions Roughing~Finishing	RPM	FEED	Vc	Fz	RPM	FEED	Vc	Fz	ap
8	6370~11940	2550~3580	160~300	0.20~0.15	5970~7960	7160~6370	150~200	0.60~0.40	0.4
10, 11	5090~9550	2040~2860	160~300	0.20~0.15	4770~6370	7160~6370	150~200	0.75~0.50	0.5
12, 13	4240~7960	1700~2390	160~300	0.20~0.15	3980~5310	7160~6370	150~200	0.90~0.60	0.6
16, 17	3180~5970	1590~2390	160~300	0.25~0.20	2980~3980	7160~6370	150~200	1.20~0.80	0.8
20, 21	2550~4770	1270~1910	160~300	0.25~0.20	2390~3180	7160~6370	150~200	1.50~1.00	1.0
25, 26	2040~3820	1020~1530	160~300	0.25~0.20	1910~2550	7640~7640	150~200	2.00~1.50	1.3
30, 32, 33	1700~3180	850~1270	160~300	0.25~0.20	1590~2120	7320~7640	150~200	2.30~1.80	1.6

WORK MATERIALS	P								
	ALLOY STEELS HEAT RESISTANT STEELS					DIE TOOL STEELS PRE-HARDENED			
HARDNESS	HB	30~40				380~480			
	HRc	1000~1250				40~50			
STRENGTH	N/mm ²	1000~1250				1250~1500			
<i>i-Xmill</i> Type	XMR110A					XMR110A, XMR120C			
Cutting Conditions Roughing~Finishing	RPM	FEED	Vc	Fz	RPM	FEED	Vc	Fz	
8	4770~11140	1910~3340	120~280	0.20~0.15	3980~11140	990~1340	100~280	0.12~0.06	
10, 11	3820~8910	1530~2670	120~280	0.20~0.15	3180~8910	800~1070	100~280	0.13~0.06	
12, 13	3180~7430	1270~2230	120~280	0.20~0.15	2650~7430	660~890	100~280	0.12~0.06	
16, 17	2390~5570	1190~2230	120~280	0.25~0.20	1990~5570	600~840	100~280	0.15~0.08	
20, 21	1910~4460	950~1780	120~280	0.25~0.20	1590~4460	480~670	100~280	0.15~0.08	
25, 26	1530~3570	760~1430	120~280	0.25~0.20	1270~3570	380~530	100~280	0.15~0.07	
30, 32, 33	1270~2970	640~1190	120~280	0.25~0.20	1060~2970	320~450	100~280	0.15~0.08	

WORK MATERIALS	P								
	HARDENED STEELS					HIGH HARDENED STEELS			
HARDNESS	HB	420~550				550~740			
	HRc	45~55				55~65			
STRENGTH	N/mm ²	1500~				1500~			
<i>i-Xmill</i> Type	XMR120C					XMR260T			
Cutting Conditions Roughing~Finishing	RPM	FEED	Vc	Fz	RPM	FEED	Vc	Fz	
8	3180~8750	640~880	80~220	0.10~0.05	3180~8750	640~880	80~220	0.10~0.05	
10, 11	2550~7000	510~700	80~220	0.10~0.05	2550~7000	510~700	80~220	0.10~0.05	
12, 13	2120~5840	420~580	80~220	0.10~0.05	2120~5840	420~580	80~220	0.10~0.05	
16, 17	1590~4380	420~530	80~220	0.15~0.06	1590~4380	480~530	80~220	0.15~0.06	
20, 21	1270~3500	380~420	80~220	0.15~0.06	1270~3500	380~420	80~220	0.15~0.06	
25, 26	1020~2800	310~340	80~220	0.15~0.06	1020~2800	310~340	80~220	0.15~0.06	
30, 32, 33	850~2330	250~280	80~220	0.15~0.06	850~2330	250~280	80~220	0.15~0.06	

CORNER RADIUS CUTTING CONDITIONS

RPM = rev./min. Vc = m/min.
FEED = mm/min. Fz = mm/tooth

WORK MATERIALS	M				N			
	STAINLESS STEELS				GRAPHITE			
<i>i-Xmill</i> Type	XMR110A				XMR110D			
Cutting Conditions Roughing~Finishing	RPM	FEED	Vc	Fz	RPM	FEED	Vc	Fz
8	3580~5170	720~1030	90~130	0.10~0.10	11940~15920	4770~6370	300~400	0.20~0.20
10, 11	2860~4140	630~910	90~130	0.11~0.11	9550~12730	3820~5090	300~400	0.20~0.20
12, 13	2390~3450	550~790	90~130	0.12~0.11	7960~10610	3180~4240	300~400	0.20~0.20
16, 17	1790~2590	450~650	90~130	0.13~0.13	5970~7960	2390~3180	300~400	0.20~0.20
20, 21	1430~2070	360~520	90~130	0.13~0.13	4770~6370	2390~3180	300~400	0.25~0.25
25, 26	1150~1660	290~410	90~130	0.13~0.12	3820~5090	1910~2550	300~400	0.25~0.25
30, 32, 33	950~1380	240~340	90~130	0.13~0.12	3180~4240	1590~2120	300~400	0.25~0.25

WORK MATERIALS	K			
	CAST IRON			
<i>i-Xmill</i> Type	XMR120C			
Cutting Conditions Roughing~Finishing	RPM	FEED	Vc	Fz
8	6370~15120	3820~6050	160~380	0.30~0.20
10, 11	5090~12100	3060~4840	160~380	0.30~0.20
12, 13	4240~10080	2550~4030	160~380	0.30~0.20
16, 17	3180~7560	2230~4540	160~380	0.35~0.30
20, 21	2550~6050	1780~3630	160~380	0.35~0.30
25, 26	2040~4840	1430~2900	160~380	0.35~0.30
30, 32, 33	1700~4030	1190~2420	160~380	0.35~0.30

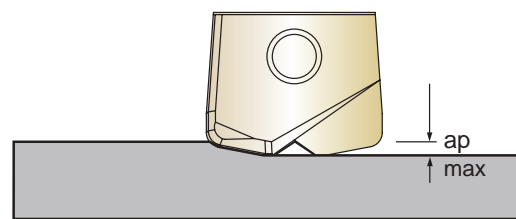

High Feed

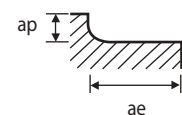

ae: Roughing - 0.1 x D
Finishing - 0.2mm
ap: Roughing - Under Ø16 : 0.025 x D
From Ø16 : 0.05 x D
Finishing - Under Ø16 : 0.1mm
From Ø16 : 0.2mm

- ▶ When the length of overhang exceed 4xD, we recommend to use carbide shank holder. (Feed 20% down)
- ▶ Recommend to reduce the feed rate to 70~85% when you use long(long & intermediate Type Holder) tools.

TROUBLE SHOOTING GUIDE

SPECIFIC PROBLEM	CAUSE	SOLUTION
Breakage	Feed rate too high	Reduce feed rate
	Depth of cut too large	Reduce depth of cut
	Tool overhang too long	Shorten tool overhang
	Rapid cutting edge wear	Reduce RPM, Replace / Regrind ASAP
Wear and burning	Cutting speed too high	Reduce cutting speed and increase coolant oil supply
	Hard material	Use higher grade tool material, add surface treatment (Coating)
Vibration during cutting process	Non-optimum combination of feed and speed	Adjust the cutting speed or feed rate
	Poor toolholder rigidity	Replace with shorter/more rigid toolholder (chuck) Use carbide holder Tighten up the screw with recommended torque
	Adjustment defect of the work material	Make sure that work material is fixed properly
Cutting edge defects	Tool overhang too long	Shorten tool overhang
	Feed rate too high	Reduce feed rate
	Vibration	Reduce RPM Use the carbide holder Tighten up the screw with recommended torque
	Work material is not fixed properly	Make sure that work material is fixed properly
	Depth of cut too large	Reduce depth of cut
	Tool overhang too long	Shorten tool overhang
Bad cutting property	Not enough rigidity of the machine	Use better machine
	Too much wear of the cutting edges	Replace / Regrind ASAP
Chip removal defects	The insert is not adapted	Replace by adapted insert
	Lower pressure or smaller amount of coolant oil	Increase the pressure and amount of coolant oil
	Smaller chip pocket	Reduce feed rate
	Higher wear of cutting edges	Replace / Regrind ASAP
Burr on the surface	Depth of cut too large	Reduce depth of cut
	Feed rate too high	Reduce feed rate
	Too much wear of the cutting edges	Replace / Regrind ASAP
Defect of the finished dimensions	Defect of machine and chuck	Repair the machine or chuck Change the screw for new one
	Defect of the machine and rigidity of the chuck	Replace the machine of chuck Use the carbide holder Tighten up the screw with recommended torque
Build up edge	Insufficient matching of the materials and tools or coolant oil	Spray the metal cutting oil in order from dry, soluble oil to non-soluble oil During the alloyed steel cutting, active non-soluble oil type is appropriate



HIGH QUALITY PRODUCTS and ON TIME DELIVERY for WORLD-WIDE CUSTOMERS

Since 1982, YG-1 has been committed to quality, innovation and the unique customer experience. Our performance and experience have granted YG-1 the global impression of one of the leading manufacturers of high quality cutting tool solutions. This global footprint expands over 75 countries, with international logistic centers, pledging to our customers to give the best service available today - and tomorrow.

EUROPE

BELGIUM	FINLAND	ITALY	PORTUGAL	SLOVENIA	THE NETHERLANDS
CROATIA	FRANCE	LITHUANIA	ROMANIA	SPAIN	TURKEY
CZECH REPUBLIC	GERMANY	NORWAY	RUSSIA	SWEDEN	UNITED KINGDOM
DENMARK	HUNGARY	POLAND	SERBIA	SWITZERLAND	

ASIA PACIFIC

AUSTRALIA	INDONESIA	KINGDOM OF SAUDI ARABIA	SINGAPORE	UNITED ARAB EMIRATES
CHINA	IRAN	MALAYSIA	SOUTH KOREA	VIETNAM
HONG KONG	ISRAEL	PAKISTAN	TAIWAN	
INDIA	JAPAN	PHILIPPINES	THAILAND	

AMERICAS

BRAZIL	CANADA	COLOMBIA	MEXICO	UNITED STATES
--------	--------	----------	--------	---------------

AFRICA

EGYPT	SOUTH AFRICA
-------	--------------

YG-1 CO., LTD.

* For the more information on sales network, please contact the head office as below;

YG-1 HEAD OFFICE

211, Sewolcheon-ro, Bupyeong-gu, Incheon, South Korea
Phone : +82-32-526-0909
E-mail : yg1@yg1.kr
www.yg1.kr